

50 AMP BUTTON DIODES

FEATURES

- PROPRIETARY **SOFT GLASS[®]** JUNCTION PASSIVATION FOR SUPERIOR RELIABILITY AND PERFORMANCE
- VOID FREE VACUUM DIE SOLDERING FOR MAXIMUM MECHANICAL STRENGTH AND HEAT DISSIPATION (Solder Voids: Typical $\leq 2\%$, Max. $\leq 10\%$ of Die Area)
- Compact molded design
- High surge current, 720 A @ $T_J = 175^\circ\text{C}$
- Low cost
- Peak performance at elevated temperatures: 50 A @ $T_J = 175^\circ\text{C}$

MECHANICAL SPECIFICATION

Die Size:
 0.180" x 0.180"
 Square

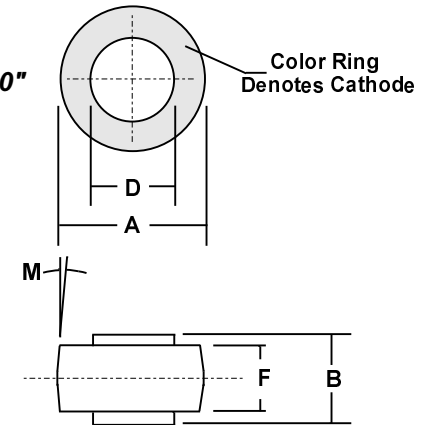

MECHANICAL DATA

- Case: Molded Epoxy (UL Flammability Rating 94V-0)
- Finish: All external surfaces are corrosion resistant and the contact areas are readily solderable
- Soldering Temperature: 250 °C maximum
- Mounting Position: Any
- Polarity: Color band denotes cathode
- Weight: 0.6 Ounces (1.8 Grams)

RoHS COMPLIANT

DIM	MILLIMETERS		INCHES	
	MIN	MAX	MIN	MAX
A	8.43	8.69	0.332	0.342
B	5.94	6.25	0.234	0.246
D	5.46	5.71	0.215	0.225
F	4.19	4.45	0.165	0.175
M	5° NOM		5° NOM	

MAXIMUM RATINGS & ELECTRICAL CHARACTERISTICS

Ratings at 25 °C ambient temperature unless otherwise specified.

PARAMETER (TEST CONDITIONS)	SYMBOL	RATINGS							UNITS
		BAR 5000S	BAR 5001S	BAR 5002S	BAR 5004S	BAR 5006S	BAR 5008S	BAR 5010S	
Series Number									
Maximum DC Blocking Voltage	V_{RRM}								VOLTS
Maximum RMS Voltage	V_{RWM}	50	100	200	400	600	800	1000	
Maximum Peak Recurrent Reverse Voltage	V_{DC}								
Non-repetitive Peak Reverse Voltage (Half wave, single phase, 60 Hz peak)	V_{RSM}	60	120	240	480	720	960	1200	
Average Forward Rectified Current @ $T_c=125^\circ\text{C}$	I_O	50							AMPS
Peak Forward Surge Current (8.3mS single half sine wave superimposed on rated load)	I_{FSM}	600							
Maximum Forward Voltage Drop at 50 Amp DC	V_{FM}	1.1 (Typical 1.05)					1.15		VOLTS
Maximum Average DC Reverse Current @ $T_A = 25^\circ\text{C}$ At Rated DC Blocking Voltage @ $T_A = 100^\circ\text{C}$	I_{RM}	1 50							μA
Maximum Thermal Resistance, Junction to Case (Note 1)	$R_{\theta JC}$	0.8							$^\circ\text{C/W}$
Junction Operating and Storage Temperature Range	T_J, T_{STG}	-65 to +175							$^\circ\text{C}$

Notes: 1) Single Side Cooled

BAR305