

TOSHIBA Field Effect Transistor Silicon P Channel MOS Type (U-MOS III)

SSM6J21TU

High Current Switching Applications

- Suitable for high-density mounting due to compact package
- Low on resistance: $R_{on} = 88 \text{ m}\Omega \text{ (max) (@}V_{GS} = -2.5 \text{ V)}$

Absolute Maximum Ratings (Ta = 25°C)

Characteristics		Symbol	Rating	Unit
Drain-Source voltage		V_{DS}	-12	V
Gate-Source voltage		V_{GSS}	± 12	V
Drain current	DC	I_D	-3	A
	Pulse	I_{DP}	-6	
Drain power dissipation		P_D (Note 1)	500	mW
Channel temperature		T_{ch}	150	°C
Storage temperature range		T_{stg}	-55~150	°C

Note: Using continuously under heavy loads (e.g. the application of high temperature/current/voltage and the significant change in temperature, etc.) may cause this product to decrease in the reliability significantly even if the operating conditions (i.e. operating temperature/current/voltage, etc.) are within the absolute maximum ratings.

Please design the appropriate reliability upon reviewing the Toshiba Semiconductor Reliability Handbook ("Handling Precautions"/"Derating Concept and Methods") and individual reliability data (i.e. reliability test report and estimated failure rate, etc).

Note 1: Mounted on FR4 board.
(25.4 mm × 25.4 mm × 1.6 t, Cu Pad: 645 mm²)

Unit: mm

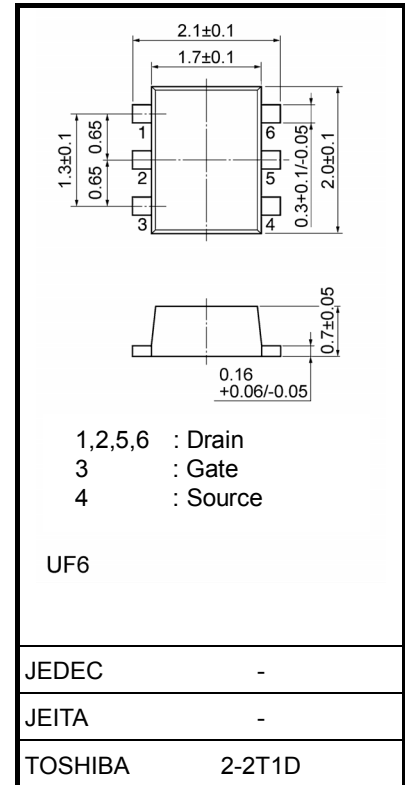

Weight: 7 mg (typ.)

Marking

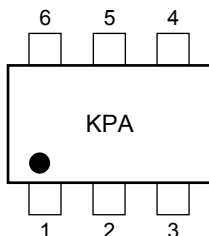

Equivalent Circuit

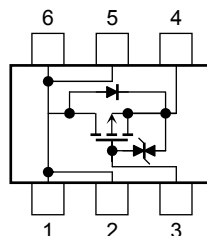

Handling Precaution

When handling individual devices (which are not yet mounting on a circuit board), be sure that the environment is protected against electrostatic discharge. Operators should wear anti-static clothing and use containers and other objects that are made of anti-static materials.

Electrical Characteristics (Ta = 25°C)

Characteristics	Symbol	Test Condition	Min	Typ.	Max	Unit
Gate leakage current	I_{GSS}	$V_{GS} = \pm 10\text{ V}, V_{DS} = 0$	-	-	± 1	μA
Drain-Source breakdown voltage	$V_{(BR)DSS}$	$I_D = -1\text{ mA}, V_{GS} = 0$	-12	-	-	V
	$V_{(BR)DSX}$	$I_D = -1\text{ mA}, V_{GS} = +8\text{ V}$	-4	-	-	
Drain cut-off current	I_{DSS}	$V_{DS} = -12\text{ V}, V_{GS} = 0$	-	-	-1	μA
Gate threshold voltage	V_{th}	$V_{DS} = -3\text{ V}, I_D = -0.1\text{ mA}$	-0.5	-	-1.1	V
Forward transfer admittance	$ Y_{fs} $	$V_{DS} = -3\text{ V}, I_D = -1.5\text{ A}$ (Note2)	4.3	-	-	S
Drain-Source ON resistance	$R_{DS(ON)}$	$I_D = -1.5\text{ A}, V_{GS} = -4\text{ V}$ (Note2)	-	35	50	m Ω
		$I_D = -1.5\text{ A}, V_{GS} = -2.5\text{ V}$ (Note2)	-	50	88	
Input capacitance	C_{iss}	$V_{DS} = -10\text{ V}, V_{GS} = 0, f = 1\text{ MHz}$	-	1300	-	pF
Reverse transfer capacitance	C_{rss}	$V_{DS} = -10\text{ V}, V_{GS} = 0, f = 1\text{ MHz}$	-	330	-	pF
Output capacitance	C_{oss}	$V_{DS} = -10\text{ V}, V_{GS} = 0, f = 1\text{ MHz}$	-	400	-	pF
Switching time	Turn-on time	t_{on}	-	68	-	ns
	Turn-off time	t_{off}	-	76	-	

Note2: Pulse test

Switching Time Test Circuit

(a) Test Circuit

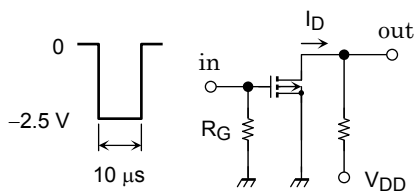

$V_{DD} = -10\text{ V}$
 $R_G = 4.7\ \Omega$
 D.U. $\leq 1\%$
 V_{IN} : $t_r, t_f < 5\text{ ns}$
 Common Source
 $T_a = 25^\circ\text{C}$

(b) V_{IN}

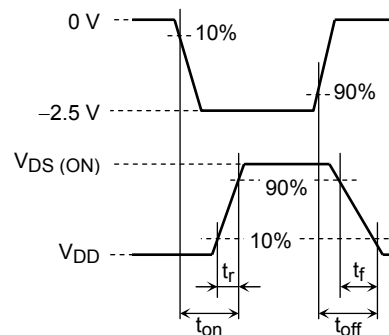

(c) V_{OUT}

Precaution

V_{th} can be expressed as voltage between gate and source when low operating current value is $I_D = -100\ \mu\text{A}$ for this product. For normal switching operation, $V_{GS(ON)}$ requires higher voltage than V_{th} and $V_{GS(OFF)}$ requires lower voltage than V_{th} .

(Relationship can be established as follows: $V_{GS(OFF)} < V_{th} < V_{GS(ON)}$)

Please take this into consideration for using the device.

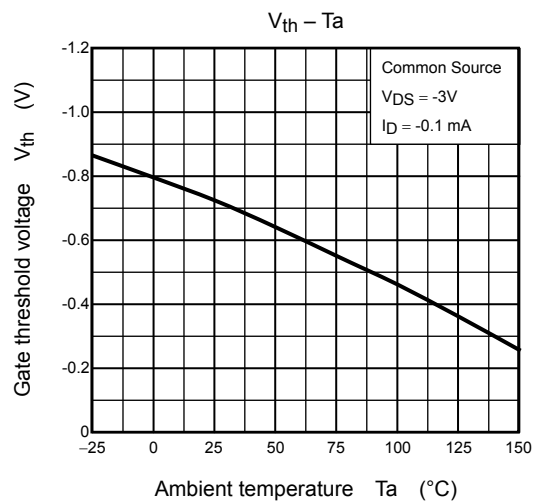
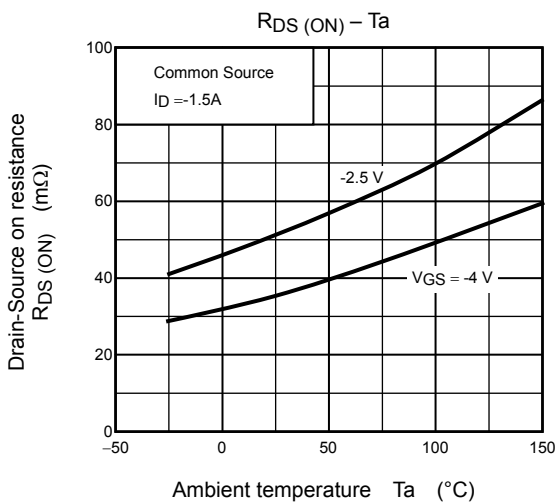
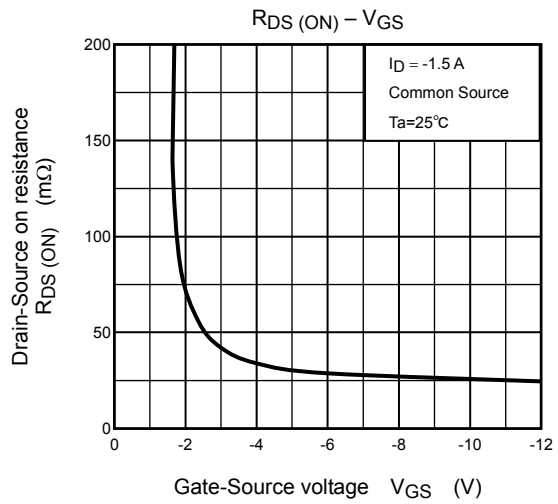
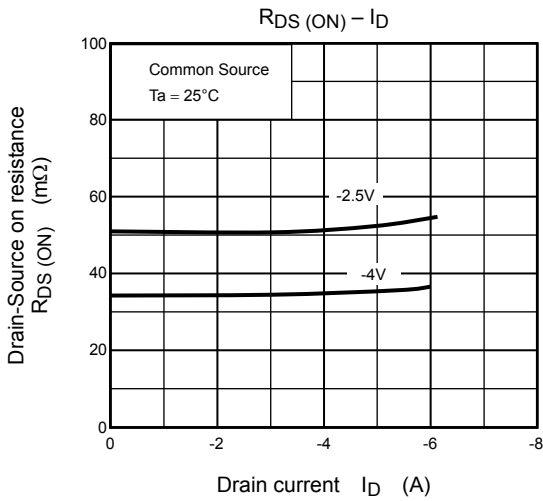
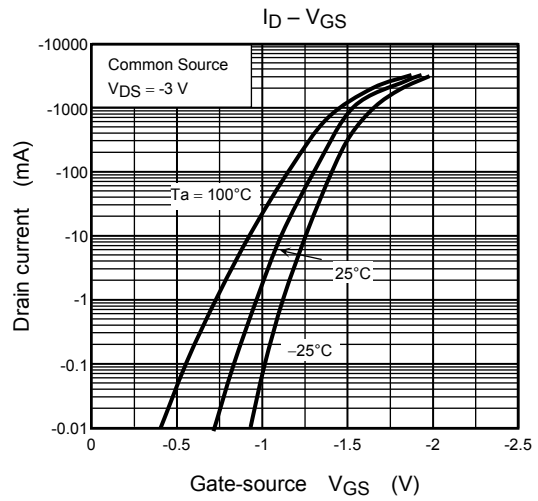
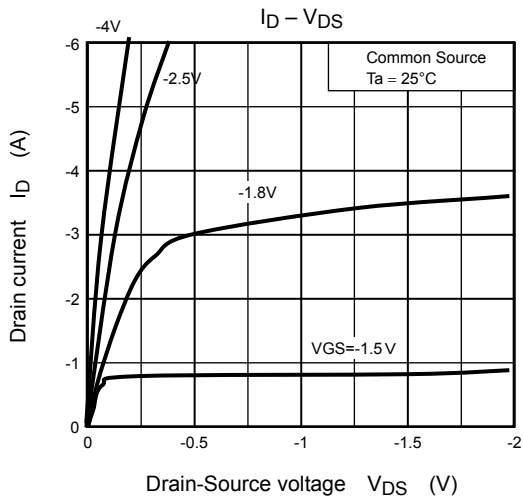

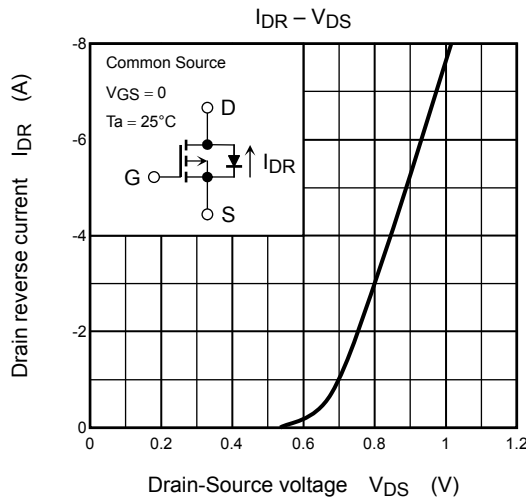
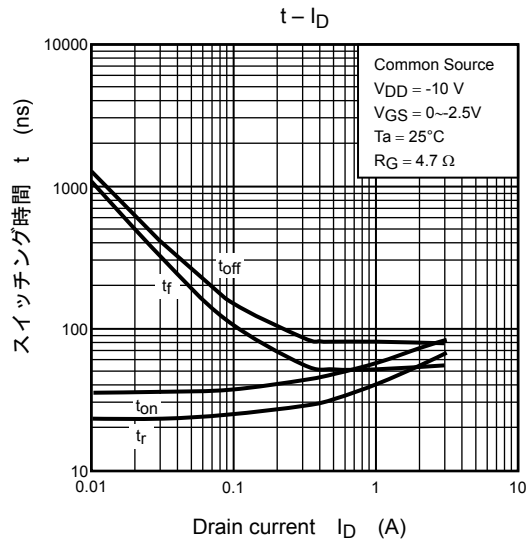
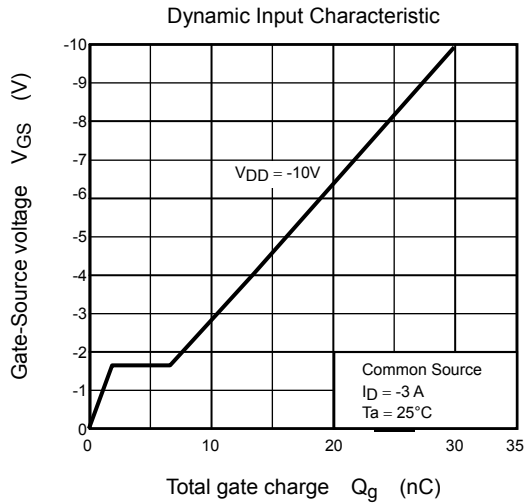
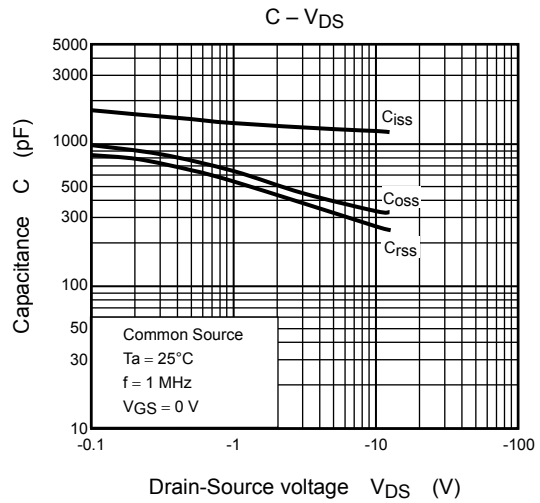
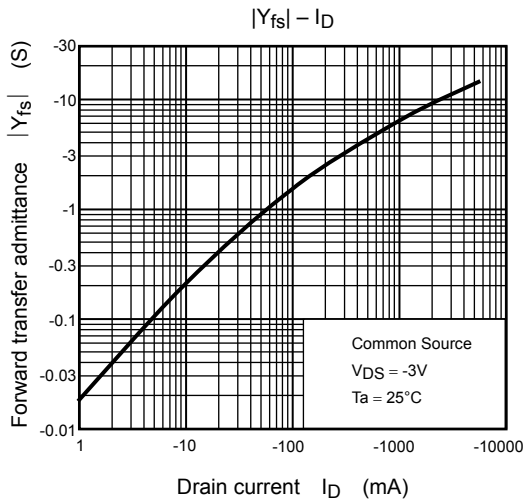

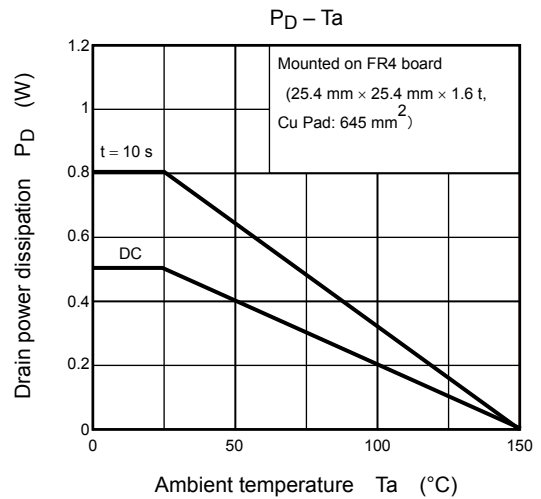
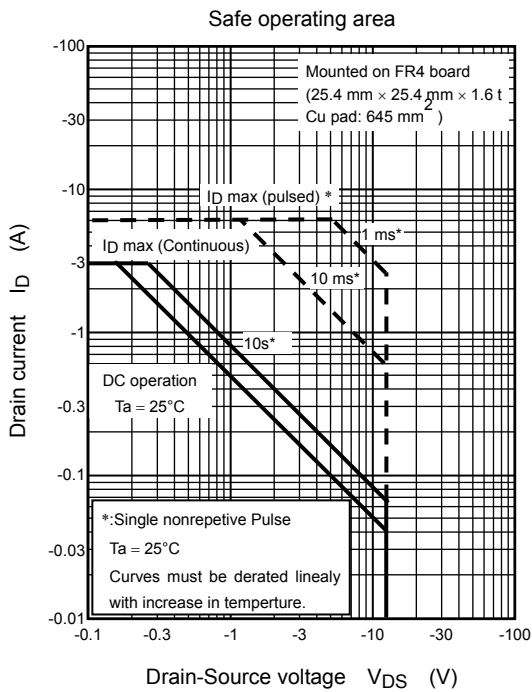
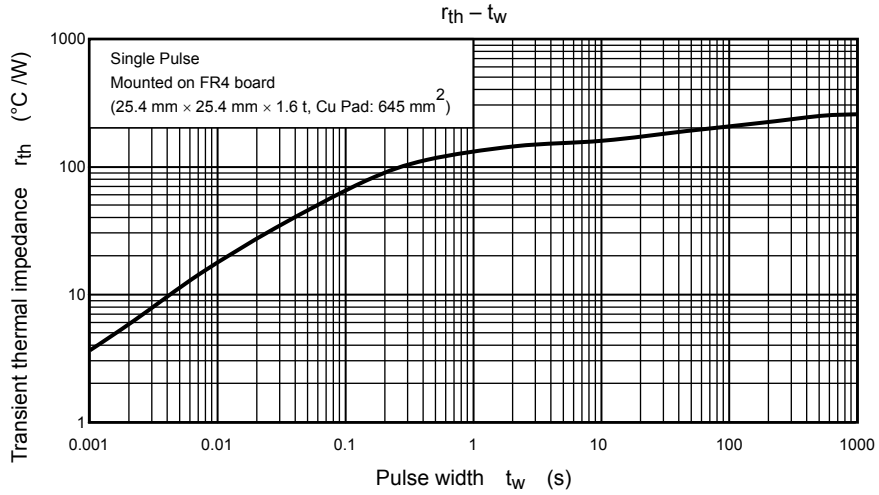

RESTRICTIONS ON PRODUCT USE

20070701-EN GENERAL

- The information contained herein is subject to change without notice.
- TOSHIBA is continually working to improve the quality and reliability of its products. Nevertheless, semiconductor devices in general can malfunction or fail due to their inherent electrical sensitivity and vulnerability to physical stress. It is the responsibility of the buyer, when utilizing TOSHIBA products, to comply with the standards of safety in making a safe design for the entire system, and to avoid situations in which a malfunction or failure of such TOSHIBA products could cause loss of human life, bodily injury or damage to property.
In developing your designs, please ensure that TOSHIBA products are used within specified operating ranges as set forth in the most recent TOSHIBA products specifications. Also, please keep in mind the precautions and conditions set forth in the "Handling Guide for Semiconductor Devices," or "TOSHIBA Semiconductor Reliability Handbook" etc.
- The TOSHIBA products listed in this document are intended for usage in general electronics applications (computer, personal equipment, office equipment, measuring equipment, industrial robotics, domestic appliances, etc.). These TOSHIBA products are neither intended nor warranted for usage in equipment that requires extraordinarily high quality and/or reliability or a malfunction or failure of which may cause loss of human life or bodily injury ("Unintended Usage"). Unintended Usage include atomic energy control instruments, airplane or spaceship instruments, transportation instruments, traffic signal instruments, combustion control instruments, medical instruments, all types of safety devices, etc.. Unintended Usage of TOSHIBA products listed in this document shall be made at the customer's own risk.
- The products described in this document shall not be used or embedded to any downstream products of which manufacture, use and/or sale are prohibited under any applicable laws and regulations.
- The information contained herein is presented only as a guide for the applications of our products. No responsibility is assumed by TOSHIBA for any infringements of patents or other rights of the third parties which may result from its use. No license is granted by implication or otherwise under any patents or other rights of TOSHIBA or the third parties.
- Please contact your sales representative for product-by-product details in this document regarding RoHS compatibility. Please use these products in this document in compliance with all applicable laws and regulations that regulate the inclusion or use of controlled substances. Toshiba assumes no liability for damage or losses occurring as a result of noncompliance with applicable laws and regulations.