

TC7PA175FU

D-Type Flip-Flop with Clear

Features

- Operating voltage range: $V_{CC} = 1.8\sim 3.6\text{ V}$
- High-speed operation: $t_{pd} = 3.5\text{ ns (max) at } V_{CC} = 3.0\sim 3.6\text{ V}$
 $t_{pd} = 4.6\text{ ns (max) at } V_{CC} = 2.3\sim 2.7\text{ V}$
 $t_{pd} = 9.2\text{ ns (max) at } V_{CC} = 1.8\text{ V}$
- High-level output current:
 $I_{OH}/I_{OL} = \pm 24\text{ mA (min) at } V_{CC} = 3.0\text{ V}$
 $I_{OH}/I_{OL} = \pm 18\text{ mA (min) at } V_{CC} = 2.3\text{ V}$
 $I_{OH}/I_{OL} = \pm 6\text{ mA (min) at } V_{CC} = 1.8\text{ V}$
- 3.6-V tolerant inputs
- 3.6-V power down protection output

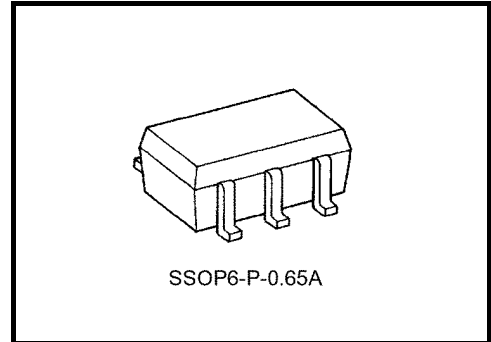

Weight: 0.0068 g (typ.)

Absolute Maximum Ratings (Ta = 25°C)

Characteristics	Symbol	Value	Unit
Power supply voltage	V_{CC}	-0.5~4.6	V
DC input voltage	V_{IN}	-0.5~4.6	V
DC output voltage	V_{OUT}	-0.5~4.6 (Note 1)	V
		-0.5~ $V_{CC} + 0.5$ (Note 2)	
Input diode current	I_{IK}	-50	mA
Output diode current	I_{OK}	-50 (Note 3)	mA
DC output current	I_{OUT}	± 50	mA
Power dissipation	P_D	200	mW
DC V_{CC} /ground current	I_{CC}	± 100	mA
Storage temperature	T_{stg}	-65~150	°C

Note: Using continuously under heavy loads (e.g. the application of high temperature/current/voltage and the significant change in temperature, etc.) may cause this product to decrease in the reliability significantly even if the operating conditions (i.e. operating temperature/current/voltage, etc.) are within the absolute maximum ratings and the operating ranges.

Please design the appropriate reliability upon reviewing the Toshiba Semiconductor Reliability Handbook ("Handling Precautions"/"Derating Concept and Methods") and individual reliability data (i.e. reliability test report and estimated failure rate, etc).

Note 1: $V_{CC} = 0\text{ V}$

Note 2: High or Low state. The I_{OUT} absolute maximum rating must be adhered to.

Note 3: $V_{OUT} < GND$

Marking

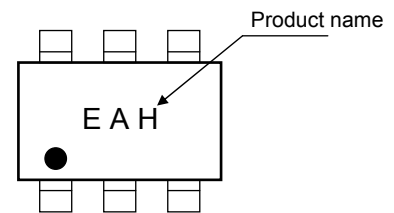

Pin Assignment (top view)

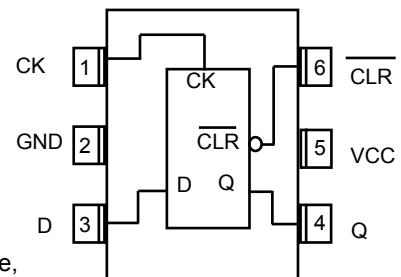

IEC Logic Symbol

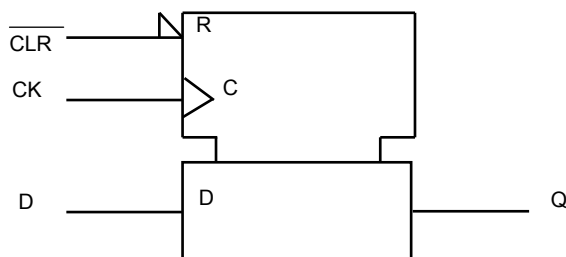

Truth Table

INPUTS			OUTPUT	FUNCTION
$\overline{\text{CLR}}$	D	CK	Q	
L	X	X	L	CLEAR
H	L		L	—
H	H		H	—
H	X		Qn	NO CHANGE

X: Don't care

Operating Ranges

Characteristics	Symbol	Value	Unit
Power supply voltage	V_{CC}	1.8~3.6	V
		1.2~3.6 (Note 4)	
Input voltage	V_{IN}	-0.3~3.6	V
Output voltage	V_{OUT}	0~3.6 (Note 5)	V
		0~ V_{CC} (Note 6)	
Output Current	I_{OH}/I_{OL}	± 24 (Note 7)	mA
		± 18 (Note 8)	
		± 6 (Note 9)	
Operating temperature	T_{opr}	-40~85	$^{\circ}\text{C}$
Input rise and fall time	d_t/d_v	0~10 (Note 10)	ns/V

Note 4: Data retention only

Note 5: $V_{CC} = 0\text{ V}$

Note 6: High or Low state

Note 7: $V_{CC} = 3.0\sim 3.6\text{ V}$

Note 8: $V_{CC} = 2.3\sim 2.7\text{ V}$

Note 9: $V_{CC} = 1.8\text{ V}$

Note 10: $V_{IN} = 0.8\sim 2.0\text{ V}$, $V_{CC} = 3.0\text{ V}$

DC Electrical Characteristics (Ta = -40~85°C, 2.7 V < VCC ≤ 3.6 V)

Characteristics	Symbol	Test Condition		VCC (V)	Min	Max	Unit
High-Level Input Voltage	V _{IH}	—		2.7~3.6	2.0	—	V
Low-Level Input Voltage	V _{IL}	—		2.7~3.6	—	0.8	
High-Level Output Voltage	V _{OH}	V _{IN} = V _{IH}	I _{OH} = -100 μA	2.7~3.6	V _{CC} - 0.2	—	V
			I _{OH} = -12 mA	2.7	2.2	—	
			I _{OH} = -18 mA	3.0	2.4	—	
			I _{OH} = -24 mA	3.0	2.2	—	
Low-Level Output Voltage	V _{OL}	V _{IN} = V _{IH} or V _{IL}	I _{OL} = 100 μA	2.7~3.6	—	0.2	V
			I _{OL} = 12 mA	2.7	—	0.4	
			I _{OL} = 18 mA	3.0	—	0.4	
			I _{OL} = 24 mA	3.0	—	0.55	
Input Leakage Current	I _{IN}	V _{IN} = 0~3.6 V		2.7~3.6	—	±5.0	μA
Power-off Leakage Current	I _{OFF}	V _{IN} , V _{OUT} = 0~3.6 V		0	—	10.0	μA
Quiescent Supply Current	I _{CC}	V _{IN} = V _{CC} or GND		2.7~3.6	—	20.0	μA
		V _{CC} ≤ (V _{IN} , V _{OUT}) ≤ 3.6 V		2.7~3.6	—	±20.0	
Increase in I _{CC} per Input	ΔI _{CC}	V _{IH} = V _{CC} - 0.6 V		2.7~3.6	—	750	

DC Electrical Characteristics (Ta = -40~85°C, 2.3 V ≤ VCC ≤ 2.7 V)

Characteristics	Symbol	Test Condition		VCC (V)	Min	Max	Unit
High-Level Input Voltage	V _{IH}	—		2.3~2.7	1.6	—	V
Low-Level Input Voltage	V _{IL}	—		2.3~2.7	—	0.7	
High-Level Output Voltage	V _{OH}	V _{IN} = V _{IH}	I _{OH} = -100 μA	2.3~2.7	V _{CC} - 0.2	—	V
			I _{OH} = -6 mA	2.3	2.0	—	
			I _{OH} = -12 mA	2.3	1.8	—	
			I _{OH} = -18 mA	2.3	1.7	—	
Low-Level Output Voltage	V _{OL}	V _{IN} = V _{IH} or V _{IL}	I _{OL} = 100 μA	2.3~2.7	—	0.2	V
			I _{OL} = 12 mA	2.3	—	0.4	
			I _{OL} = 18 mA	2.3	—	0.6	
Input Leakage Current	I _{IN}	V _{IN} = 0~3.6 V		2.3~2.7	—	±5.0	μA
Power-off Leakage Current	I _{OFF}	V _{IN} , V _{OUT} = 0~3.6 V		0	—	10.0	μA
Quiescent Supply Current	I _{CC}	V _{IN} = V _{CC} or GND		2.3~2.7	—	20.0	μA
		V _{CC} ≤ (V _{IN} , V _{OUT}) ≤ 3.6 V		2.3~2.7	—	±20.0	

DC Electrical Characteristics (Ta = -40~85°C, 1.8 V ≤ VCC < 2.3 V)

Characteristics	Symbol	Test Condition		VCC (V)	Min	Max	Unit
High-Level Input Voltage	V _{IH}	—		1.8~2.3	0.7 × V _{CC}	—	V
Low-Level Input Voltage	V _{IL}	—		1.8~2.3	—	0.2 × V _{CC}	
High-Level Output Voltage	V _{OH}	V _{IN} = V _{IH}	I _{OH} = -100 μA	1.8	V _{CC} - 0.2	—	V
			I _{OH} = -6 mA	1.8	1.4	—	
Low-Level Output Voltage	V _{OL}	V _{IN} = V _{IH} or V _{IL}	I _{OL} = 100 μA	1.8	—	0.2	
			I _{OL} = 6 mA	1.8	—	0.3	
Input Leakage Current	I _{IN}	V _{IN} = 0~3.6 V		1.8	—	±5.0	μA
Power-off Leakage Current	I _{OFF}	V _{IN} , V _{OUT} = 0~3.6 V		0	—	10.0	μA
Quiescent Supply Current	I _{CC}	V _{IN} = V _{CC} or GND		1.8	—	20.0	μA
		V _{CC} ≤ (V _{IN} , V _{OUT}) ≤ 3.6 V		1.8	—	±20.0	

AC Electrical Characteristics (Ta = -40~85°C, input t_r = t_f = 2.0 ns, C_L = 30 pF, R_L = 500 Ω)

Characteristics	Symbol	Test Condition		VCC (V)	Min	Max	Unit
Maximum Clock Frequency	f _{max}			1.8	100	—	MHz
				2.5 ± 0.2	200	—	
				3.3 ± 0.3	250	—	
Propagation Delay Time (CK-Q)	t _{pLH} t _{pHL}	(Figure 1 and 2)		1.8	1.0	9.2	ns
				2.5 ± 0.2	0.8	4.6	
				3.3 ± 0.3	0.6	3.5	
Propagation Delay Time ($\overline{\text{CLR}}$ -Q)	t _{pHL}	(Figure 1 and 3)		1.8	1.0	9.2	ns
				2.5 ± 0.2	0.8	4.6	
				3.3 ± 0.3	0.6	3.5	
Minimum Set-up Time	t _s	(Figure 1 and 2)		1.8	3.0	—	ns
				2.5 ± 0.2	1.5	—	
				3.3 ± 0.3	1.5	—	
Minimum Hold time	t _h	(Figure 1 and 2)		1.8	3.0	—	ns
				2.5 ± 0.2	1.7	—	
				3.3 ± 0.3	1.7	—	
Minimum Pulse Width (CK)	t _{w(H)} t _{w(L)}	(Figure 1 and 2)		1.8	4.0	—	ns
				2.5 ± 0.2	2.3	—	
				3.3 ± 0.3	2.3	—	
Minimum Pulse Width ($\overline{\text{CLR}}$)	t _{w(L)}	(Figure 1 and 3)		1.8	4.0	—	ns
				2.5 ± 0.2	2.3	—	
				3.3 ± 0.3	2.3	—	
Minimum Removal Time	t _{rem}	(Figure 1 and 3)		1.8	3.1	—	ns
				2.5 ± 0.2	2.0	—	
				3.3 ± 0.3	1.5	—	

For C_L = 50 pF, add approximately 300 ps to the AC maximum specification.

Capacitive Characteristics (Ta = 25°C)

Characteristics	Symbol	Test Condition	V _{CC} (V)	TYP.	Unit
Input Capacitance	C _{IN}	—	1.8, 2.5, 3.3	2.4	pF
Power Dissipation Capacitance	C _{PD}	f _{IN} = 10 MHz (Note 11)	1.8, 2.5, 3.3	11	pF

Note11: C_{PD} is defined as the value of the internal equivalent capacitance which is calculated from the operating current consumption without load.

Average operating current can be obtained by the equation:

$$I_{CC (opr.)} = C_{PD} \cdot V_{CC} \cdot f_{IN} + I_{CC}$$

Figure 1 Test Circuit

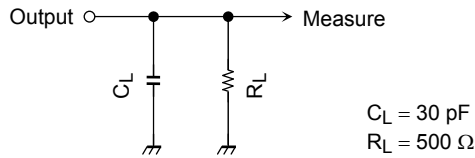

AC Waveforms

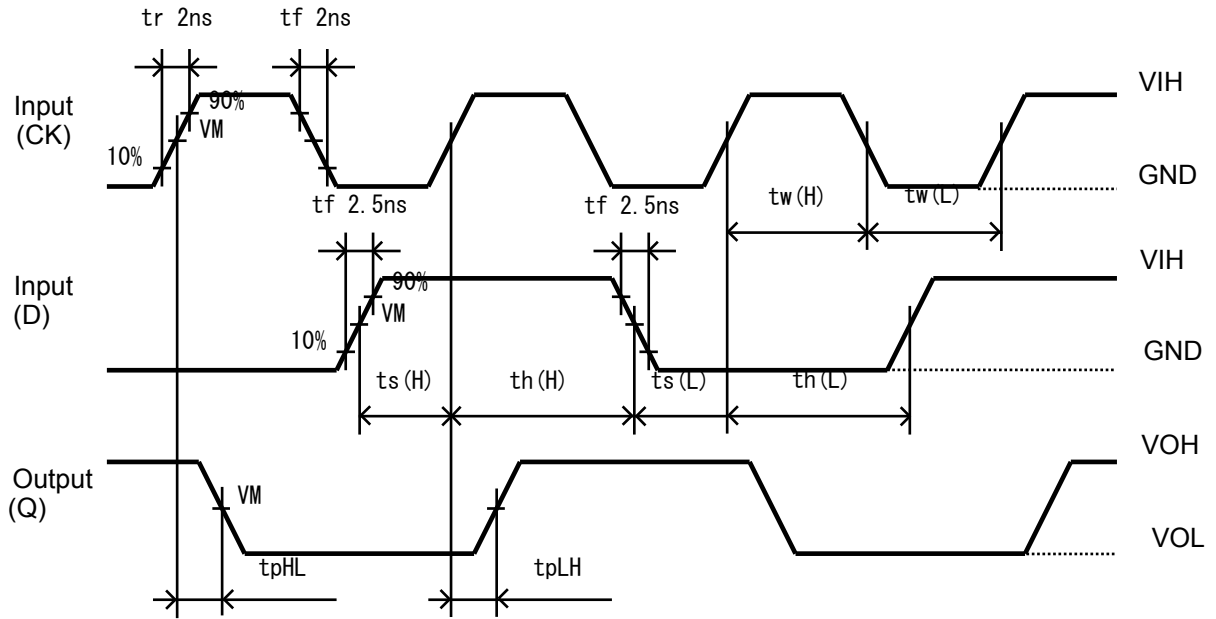

Figure 2 t_{pLH} , t_{pHL}

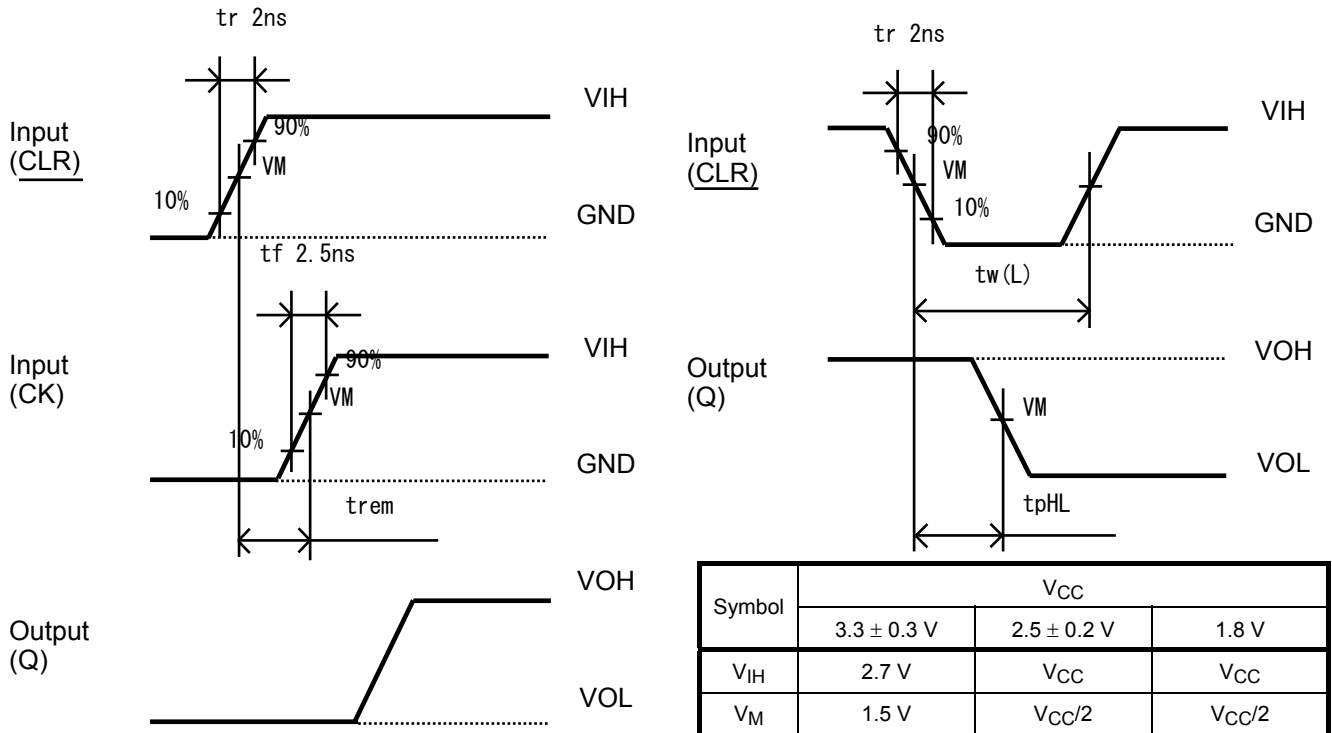
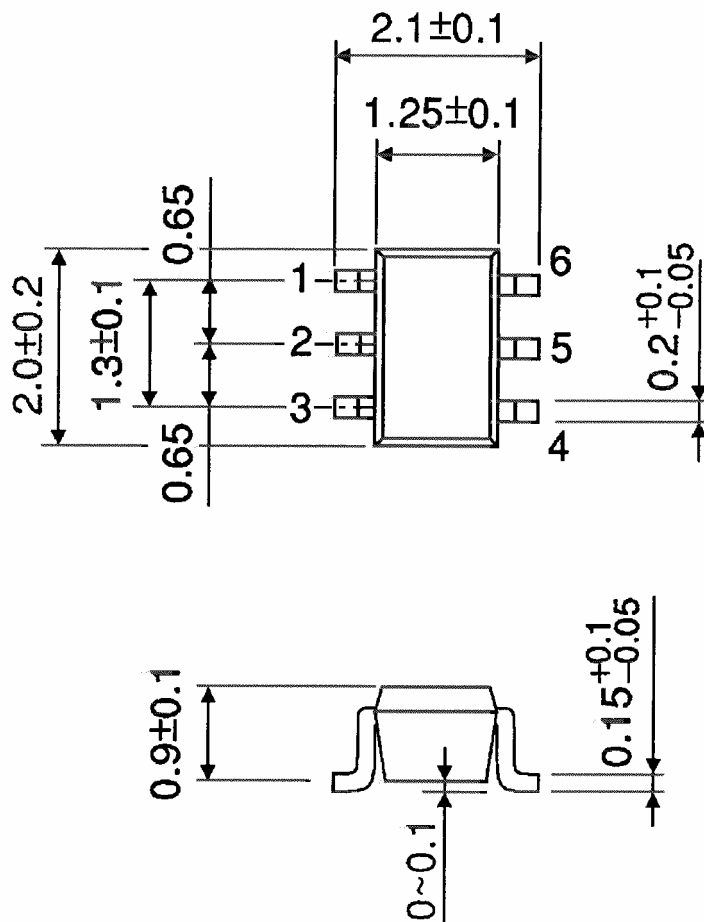

Figure 3 t_{rem} , t_{pHL} , $t_w(L)$

Package Dimensions

SSOP6-P-0.65A

Unit: mm



Weight: 0.0068 g (typ.)

RESTRICTIONS ON PRODUCT USE

20070701-EN GENERAL

- The information contained herein is subject to change without notice.
- TOSHIBA is continually working to improve the quality and reliability of its products. Nevertheless, semiconductor devices in general can malfunction or fail due to their inherent electrical sensitivity and vulnerability to physical stress. It is the responsibility of the buyer, when utilizing TOSHIBA products, to comply with the standards of safety in making a safe design for the entire system, and to avoid situations in which a malfunction or failure of such TOSHIBA products could cause loss of human life, bodily injury or damage to property.
In developing your designs, please ensure that TOSHIBA products are used within specified operating ranges as set forth in the most recent TOSHIBA products specifications. Also, please keep in mind the precautions and conditions set forth in the "Handling Guide for Semiconductor Devices," or "TOSHIBA Semiconductor Reliability Handbook" etc.
- The TOSHIBA products listed in this document are intended for usage in general electronics applications (computer, personal equipment, office equipment, measuring equipment, industrial robotics, domestic appliances, etc.). These TOSHIBA products are neither intended nor warranted for usage in equipment that requires extraordinarily high quality and/or reliability or a malfunction or failure of which may cause loss of human life or bodily injury ("Unintended Usage"). Unintended Usage include atomic energy control instruments, airplane or spaceship instruments, transportation instruments, traffic signal instruments, combustion control instruments, medical instruments, all types of safety devices, etc.. Unintended Usage of TOSHIBA products listed in this document shall be made at the customer's own risk.
- The products described in this document shall not be used or embedded to any downstream products of which manufacture, use and/or sale are prohibited under any applicable laws and regulations.
- The information contained herein is presented only as a guide for the applications of our products. No responsibility is assumed by TOSHIBA for any infringements of patents or other rights of the third parties which may result from its use. No license is granted by implication or otherwise under any patents or other rights of TOSHIBA or the third parties.
- Please contact your sales representative for product-by-product details in this document regarding RoHS compatibility. Please use these products in this document in compliance with all applicable laws and regulations that regulate the inclusion or use of controlled substances. Toshiba assumes no liability for damage or losses occurring as a result of noncompliance with applicable laws and regulations.