

TOSHIBA Bipolar Linear Integrated Circuit Silicon Monolithic

TA48M025F, TA48M03F, TA48M033F, TA48M0345F, TA48M04F, TA48M05F

2.5 V, 3 V, 3.3 V, 3.45 V, 4 V, 5 V

Three-Terminal Low Dropout Voltage Regulator

The TA48M**F series consists of fixed-positive-output, low dropout regulators with an output current of 500 mA (max). In response to the need for low voltage devices, the series offers devices with low output voltages of 2.5 V, 3 V, 3.3 V, 3.45 V, and 4 V, which are not included in the existing TA78DM**S series (0.5 A low dropout).

Features

- Maximum output current of 0.5 A
- Low standby current: 0.8 mA (typ.)
- Low dropout voltage: 0.65 V (max) @I_{OUT} = 0.5 A
- Protection function:
overheat/overcurrent/overvoltage/reversed power supply connections.
- PW-Mold package:
Surface-mount type for reflow soldering is also supported.

Pin Assignment

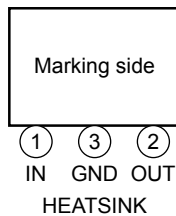

Marking

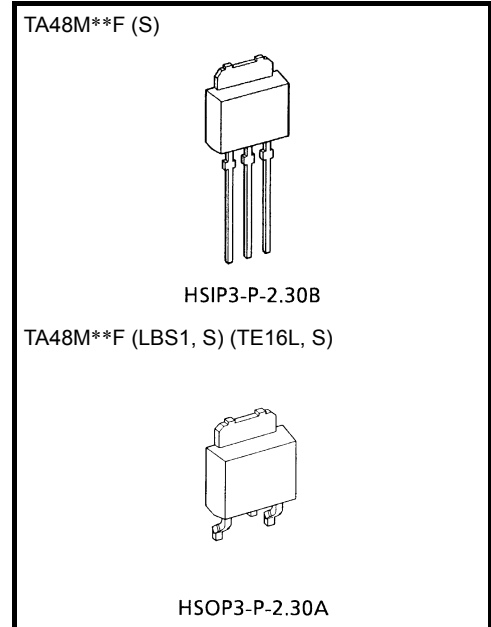
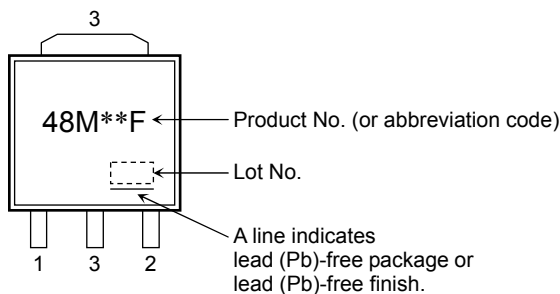

Weight
 HSIP3-P-2.30B: 0.36 g (typ.)
 HSOP3-P-2.30A: 0.36 g (typ.)

Ordering Method (Note 1)

	Product Name	Package (Lead Type)	Packing Form
1	TA48M**F (S)	PW-Mold: Straight lead	Sack (200 pcs./sack)
2	TA48M**F (LBS1, S)	PW-Mold: Surface-mount	Stick (100 pcs. max)
	TA48M**F (TE16L, S)	PW-Mold: Surface-mount	Tape (700 pcs./reel)

Note 1: The “**” in each pro-forma product name is replaced with the output voltage of each product.
For example: for 3 V, “TA48M03F”

Block Diagram

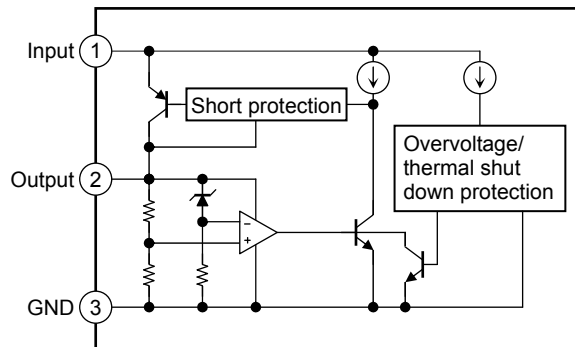

Absolute Maximum Ratings (Ta = 25°C)

Characteristics	Symbol	Rating	Unit
Input voltage	V_{IN}	29	V
Output current	I_{OUT}	0.5	A
Power dissipation	P_D	1	W
		10	
Operating temperature	T_{opr}	-40 to 85	°C
Storage temperature	T_{stg}	-55 to 150	°C
Junction temperature	T_j	150	°C
Thermal resistance	$R_{th(j-c)}$	12.5	°C/W
	$R_{th(j-a)}$	125	

Note: Using continuously under heavy loads (e.g. the application of high temperature/current/voltage and the significant change in temperature, etc.) may cause this product to decrease in the reliability significantly even if the operating conditions (i.e. operating temperature/current/voltage, etc.) are within the absolute maximum ratings and the operating ranges.

Please design the appropriate reliability upon reviewing the Toshiba Semiconductor Reliability Handbook (“Handling Precautions”/Derating Concept and Methods) and individual reliability data (i.e. reliability test report and estimated failure rate, etc).

Protection Function

Characteristics	Symbol	Min	Typ.	Max	Unit
Overvoltage	V_{IN}	29	33	—	V
Overheat	T_j	—	175	—	°C

TA48M025F

Electrical Characteristics

(unless otherwise specified, $V_{IN} = 4.5\text{ V}$, $I_{OUT} = 250\text{ mA}$, $T_j = 25^\circ\text{C}$, $C_{IN} = 0.1\ \mu\text{F}$, $C_{OUT} = 10\ \mu\text{F}$)

Characteristics	Symbol	Test Circuit	Test Condition	Min	Typ.	Max	Unit
Output voltage	V_{OUT}	—	—	2.4	2.5	2.6	V
		—	$3.5\text{ V} \leq V_{IN} \leq 16\text{ V}$, $5\text{ mA} \leq I_{OUT} \leq 500\text{ mA}$, $0^\circ\text{C} \leq T_j \leq 125^\circ\text{C}$	2.375	2.5	2.625	
Line regulation	Reg-line	—	$3.5\text{ V} \leq V_{IN} \leq 16\text{ V}$	—	7	18	mV
Load regulation	Reg-load	—	$5\text{ mA} \leq I_{OUT} \leq 500\text{ mA}$	—	45	90	mV
Quiescent current	I_B	—	$3.5\text{ V} \leq V_{IN} \leq 16\text{ V}$, $I_{OUT} = 0\text{ mA}$	—	0.8	1.4	mA
		—	$3.5\text{ V} \leq V_{IN} \leq 16\text{ V}$, $I_{OUT} = 250\text{ mA}$	—	12	25	
Output noise voltage	V_{NO}	—	$10\text{ Hz} \leq f \leq 100\text{ kHz}$, $I_{OUT} = 50\text{ mA}$	—	72	—	μVrms
Ripple rejection	R.R.	—	$f = 120\text{ Hz}$, $3.5\text{ V} \leq V_{IN} \leq 16\text{ V}$, $I_{OUT} = 50\text{ mA}$	62	72	—	dB
Dropout voltage	V_D	—	$I_{OUT} = 250\text{ mA}$	—	0.17	0.35	V
		—	$I_{OUT} = 500\text{ mA}$	—	0.35	0.65	
Peak circuit current	I_{PEAK}	—	—	0.60	1.15	1.40	A
Short circuit current	I_{SC}	—	—	0.60	1.15	1.40	A

TA48M03F

Electrical Characteristics

(unless otherwise specified, $V_{IN} = 5\text{ V}$, $I_{OUT} = 250\text{ mA}$, $T_j = 25^\circ\text{C}$, $C_{IN} = 0.1\ \mu\text{F}$, $C_{OUT} = 10\ \mu\text{F}$)

Characteristics	Symbol	Test Circuit	Test Condition	Min	Typ.	Max	Unit
Output voltage	V_{OUT}	—	—	2.88	3.0	3.12	V
		—	$4\text{ V} \leq V_{IN} \leq 16\text{ V}$, $5\text{ mA} \leq I_{OUT} \leq 500\text{ mA}$, $0^\circ\text{C} \leq T_j \leq 125^\circ\text{C}$	2.85	3.0	3.15	
Line regulation	Reg-line	—	$4\text{ V} \leq V_{IN} \leq 16\text{ V}$	—	8	21	mV
Load regulation	Reg-load	—	$5\text{ mA} \leq I_{OUT} \leq 500\text{ mA}$	—	45	95	mV
Quiescent current	I_B	—	$4\text{ V} \leq V_{IN} \leq 16\text{ V}$, $I_{OUT} = 0\text{ mA}$	—	0.8	1.4	mA
		—	$4\text{ V} \leq V_{IN} \leq 16\text{ V}$, $I_{OUT} = 250\text{ mA}$	—	12	25	
Output noise voltage	V_{NO}	—	$10\text{ Hz} \leq f \leq 100\text{ kHz}$, $I_{OUT} = 50\text{ mA}$	—	90	—	μVrms
Ripple rejection	R.R.	—	$f = 120\text{ Hz}$, $4\text{ V} \leq V_{IN} \leq 16\text{ V}$, $I_{OUT} = 50\text{ mA}$	60	70	—	dB
Dropout voltage	V_D	—	$I_{OUT} = 250\text{ mA}$	—	0.17	0.35	V
		—	$I_{OUT} = 500\text{ mA}$	—	0.35	0.65	
Peak circuit current	I_{PEAK}	—	—	0.60	1.20	1.45	A
Short circuit current	I_{SC}	—	—	0.60	1.20	1.45	A

TA48M033F

Electrical Characteristics

(unless otherwise specified, $V_{IN} = 5.3 \text{ V}$, $I_{OUT} = 250 \text{ mA}$, $T_j = 25^\circ\text{C}$, $C_{IN} = 0.1 \mu\text{F}$, $C_{OUT} = 10 \mu\text{F}$)

Characteristics	Symbol	Test Circuit	Test Condition	Min	Typ.	Max	Unit
Output voltage	V_{OUT}	—	—	3.168	3.3	3.432	V
		—	$4.3 \text{ V} \leq V_{IN} \leq 16 \text{ V}$, $5 \text{ mA} \leq I_{OUT} \leq 500 \text{ mA}$, $0^\circ\text{C} \leq T_j \leq 125^\circ\text{C}$	3.135	3.3	3.465	
Line regulation	Reg-line	—	$4.3 \text{ V} \leq V_{IN} \leq 16 \text{ V}$	—	10	23	mV
Load regulation	Reg-load	—	$5 \text{ mA} \leq I_{OUT} \leq 500 \text{ mA}$	—	45	105	mV
Quiescent current	I_B	—	$4.3 \text{ V} \leq V_{IN} \leq 16 \text{ V}$, $I_{OUT} = 0 \text{ mA}$	—	0.8	1.4	mA
		—	$4.3 \text{ V} \leq V_{IN} \leq 16 \text{ V}$, $I_{OUT} = 250 \text{ mA}$	—	12	25	
Output noise voltage	V_{NO}	—	$10 \text{ Hz} \leq f \leq 100 \text{ kHz}$, $I_{OUT} = 50 \text{ mA}$	—	90	—	μVrms
Ripple rejection	R.R.	—	$f = 120 \text{ Hz}$, $4.3 \text{ V} \leq V_{IN} \leq 16 \text{ V}$, $I_{OUT} = 50 \text{ mA}$	60	70	—	dB
Dropout voltage	V_D	—	$I_{OUT} = 250 \text{ mA}$	—	0.17	0.35	V
		—	$I_{OUT} = 500 \text{ mA}$	—	0.35	0.65	
Peak circuit current	I_{PEAK}	—	—	0.60	1.20	1.45	A
Short circuit current	I_{SC}	—	—	0.60	1.20	1.45	A

TA48M0345F

Electrical Characteristics

(unless otherwise specified, $V_{IN} = 5.45 \text{ V}$, $I_{OUT} = 250 \text{ mA}$, $T_j = 25^\circ\text{C}$, $C_{IN} = 0.1 \mu\text{F}$, $C_{OUT} = 10 \mu\text{F}$)

Characteristics	Symbol	Test Circuit	Test Condition	Min	Typ.	Max	Unit
Output voltage	V_{OUT}	—	—	3.312	3.45	3.588	V
		—	$4.45 \text{ V} \leq V_{IN} \leq 16 \text{ V}$, $5 \text{ mA} \leq I_{OUT} \leq 500 \text{ mA}$, $0^\circ\text{C} \leq T_j \leq 125^\circ\text{C}$	3.278	3.45	3.622	
Line regulation	Reg-line	—	$4.45 \text{ V} \leq V_{IN} \leq 16 \text{ V}$	—	12	25	mV
Load regulation	Reg-load	—	$5 \text{ mA} \leq I_{OUT} \leq 500 \text{ mA}$	—	45	110	mV
Quiescent current	I_B	—	$4.45 \text{ V} \leq V_{IN} \leq 16 \text{ V}$, $I_{OUT} = 0 \text{ mA}$	—	0.8	1.4	mA
		—	$4.45 \text{ V} \leq V_{IN} \leq 16 \text{ V}$, $I_{OUT} = 250 \text{ mA}$	—	12	25	
Output noise voltage	V_{NO}	—	$10 \text{ Hz} \leq f \leq 100 \text{ kHz}$, $I_{OUT} = 50 \text{ mA}$	—	90	—	μVrms
Ripple rejection	R.R.	—	$f = 120 \text{ Hz}$, $4.45 \text{ V} \leq V_{IN} \leq 16 \text{ V}$, $I_{OUT} = 50 \text{ mA}$	60	70	—	dB
Dropout voltage	V_D	—	$I_{OUT} = 250 \text{ mA}$	—	0.17	0.35	V
		—	$I_{OUT} = 500 \text{ mA}$	—	0.35	0.65	
Peak circuit current	I_{PEAK}	—	—	0.60	1.20	1.45	A
Short circuit current	I_{SC}	—	—	0.60	1.20	1.45	A

TA48M04F

Electrical Characteristics

(unless otherwise specified, $V_{IN} = 6\text{ V}$, $I_{OUT} = 250\text{ mA}$, $T_j = 25^\circ\text{C}$, $C_{IN} = 0.1\ \mu\text{F}$, $C_{OUT} = 10\ \mu\text{F}$)

Characteristics	Symbol	Test Circuit	Test Condition	Min	Typ.	Max	Unit
Output voltage	V_{OUT}	—	—	3.84	4.0	4.16	V
		—	$5\text{ V} \leq V_{IN} \leq 16\text{ V}$, $5\text{ mA} \leq I_{OUT} \leq 500\text{ mA}$, $0^\circ\text{C} \leq T_j \leq 125^\circ\text{C}$	3.8	4.0	4.2	
Line regulation	Reg.line	—	$5\text{ V} \leq V_{IN} \leq 16\text{ V}$	—	11	28	mV
Load regulation	Reg.load	—	$5\text{ mA} \leq I_{OUT} \leq 500\text{ mA}$	—	45	115	mV
Quiescent current	I_B	—	$5\text{ V} \leq V_{IN} \leq 16\text{ V}$, $I_{OUT} = 0\text{ mA}$	—	0.9	1.4	mA
		—	$5\text{ V} \leq V_{IN} \leq 16\text{ V}$, $I_{OUT} = 250\text{ mA}$	—	13	25	
Output noise voltage	V_{NO}	—	$10\text{ Hz} \leq f \leq 100\text{ kHz}$, $I_{OUT} = 50\text{ mA}$	—	110	—	μVrms
Ripple rejection	R.R.	—	$f = 120\text{ Hz}$, $5\text{ V} \leq V_{IN} \leq 16\text{ V}$, $I_{OUT} = 50\text{ mA}$	58	68	—	dB
Dropout voltage	V_D	—	$I_{OUT} = 250\text{ mA}$	—	0.17	0.35	V
		—	$I_{OUT} = 500\text{ mA}$	—	0.35	0.65	
Peak circuit current	I_{PEAK}	—	—	0.60	1.25	1.50	A
Short circuit current	I_{SC}	—	—	0.60	1.25	1.50	A

TA48M05F

Electrical Characteristics

(unless otherwise specified, $V_{IN} = 7\text{ V}$, $I_{OUT} = 250\text{ mA}$, $T_j = 25^\circ\text{C}$, $C_{IN} = 0.1\ \mu\text{F}$, $C_{OUT} = 10\ \mu\text{F}$)

Characteristics	Symbol	Test Circuit	Test Condition	Min	Typ.	Max	Unit
Output voltage	V_{OUT}	—	—	4.8	5.0	5.2	V
		—	$6\text{ V} \leq V_{IN} \leq 18\text{ V}$, $5\text{ mA} \leq I_{OUT} \leq 500\text{ mA}$, $0^\circ\text{C} \leq T_j \leq 125^\circ\text{C}$	4.75	5.0	5.25	
Line regulation	Reg.line	—	$6\text{ V} \leq V_{IN} \leq 18\text{ V}$	—	15	35	mV
Load regulation	Reg.load	—	$5\text{ mA} \leq I_{OUT} \leq 500\text{ mA}$	—	50	135	mV
Quiescent current	I_B	—	$6\text{ V} \leq V_{IN} \leq 18\text{ V}$, $I_{OUT} = 0\text{ mA}$	—	1.0	1.4	mA
		—	$6\text{ V} \leq V_{IN} \leq 18\text{ V}$, $I_{OUT} = 250\text{ mA}$	—	13	25	
Output noise voltage	V_{NO}	—	$10\text{ Hz} \leq f \leq 100\text{ kHz}$, $I_{OUT} = 50\text{ mA}$	—	125	—	μVrms
Ripple rejection	R.R.	—	$f = 120\text{ Hz}$, $6\text{ V} \leq V_{IN} \leq 18\text{ V}$, $I_{OUT} = 50\text{ mA}$	58	68	—	dB
Dropout voltage	V_D	—	$I_{OUT} = 250\text{ mA}$	—	0.17	0.35	V
		—	$I_{OUT} = 500\text{ mA}$	—	0.35	0.65	
Peak circuit current	I_{PEAK}	—	—	0.60	1.30	1.55	A
Short circuit current	I_{SC}	—	—	0.60	1.30	1.55	A

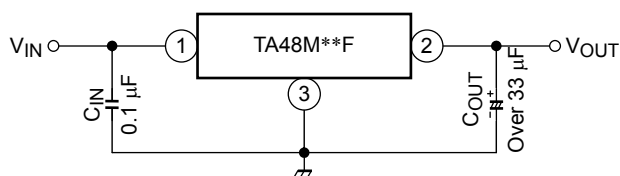
Standard Application Circuit

Be sure to connect a capacitor near the input terminal and output terminal between both terminals and GND. The capacitances should be determined experimentally. In particular, adequate investigation should be made so that there is no problem even in high or low temperatures.

Note: Depending on the type of capacitor being used to connect to the output, characteristics (capacitance, frequency and others) may decline and the output may oscillate. To prevent this, Toshiba recommends a tantalum electrolytic capacitor that has a small fluctuation in capacitance characteristics.

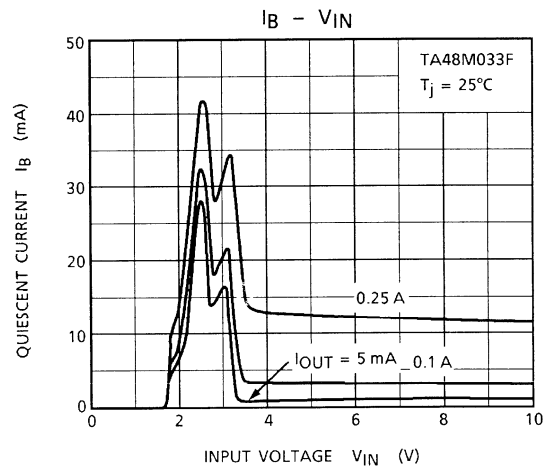
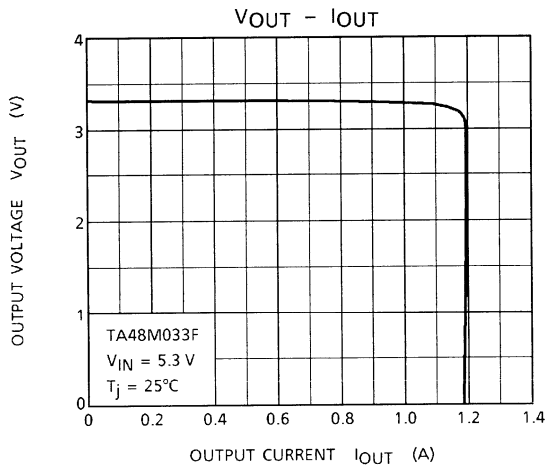
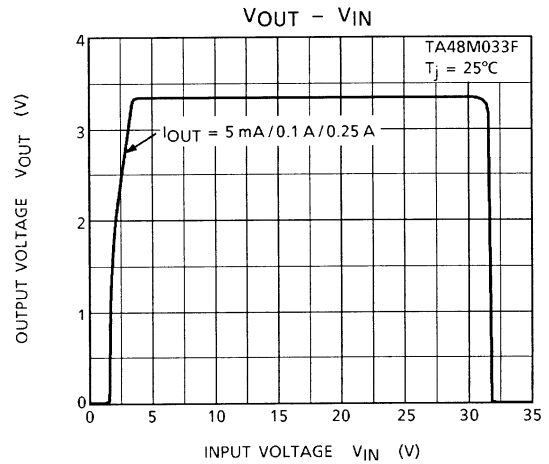
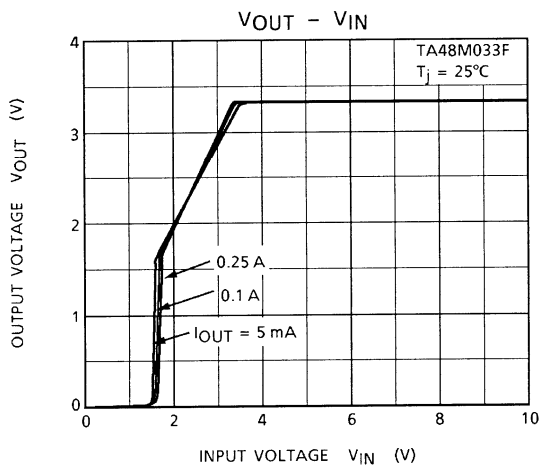
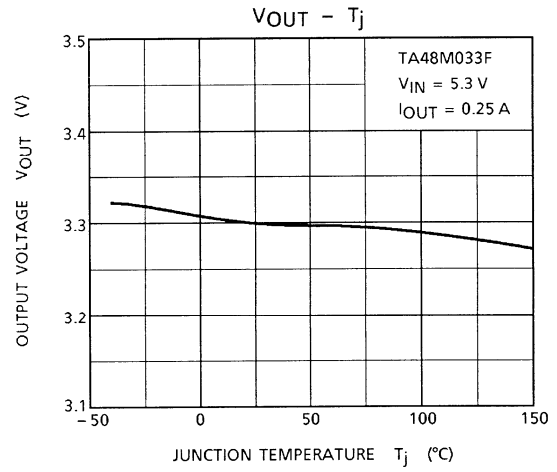
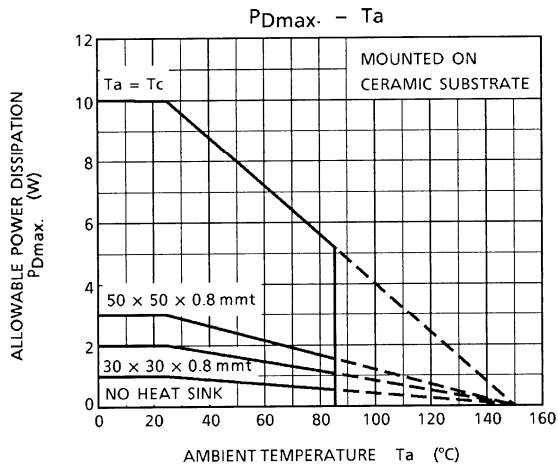

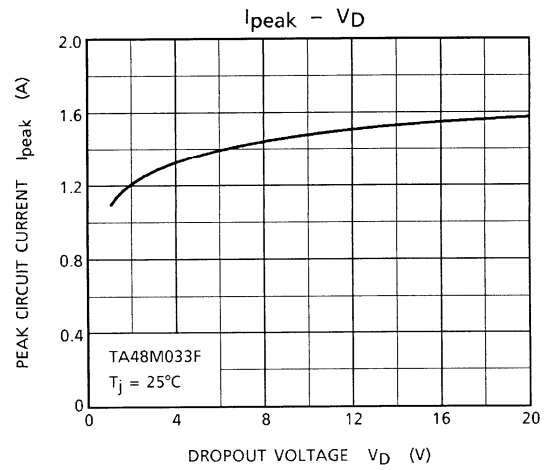
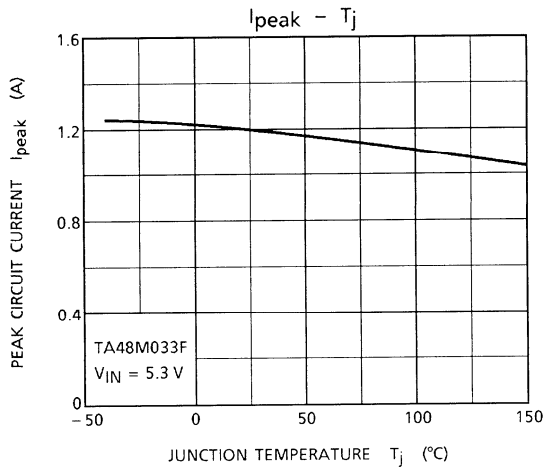
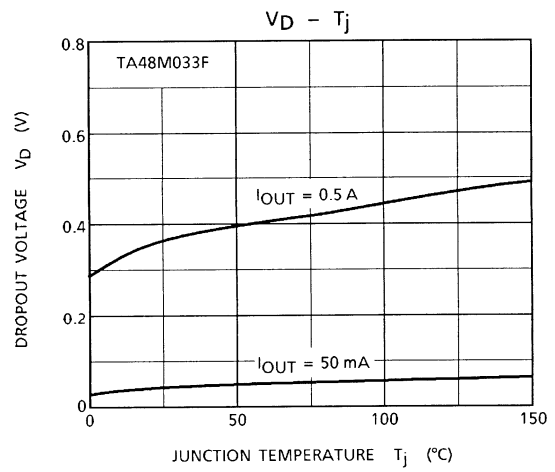
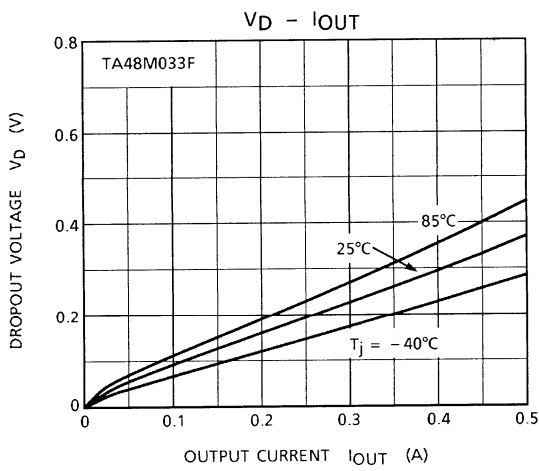
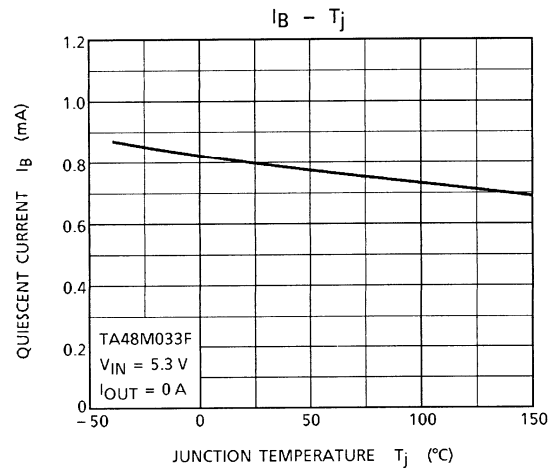
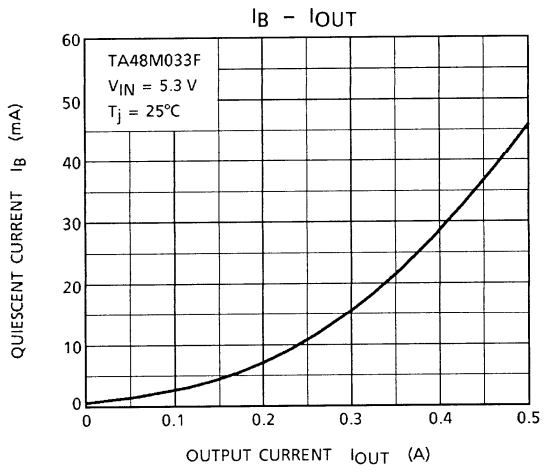

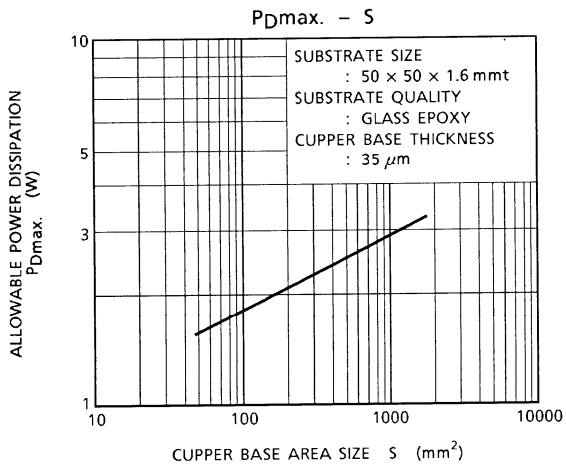
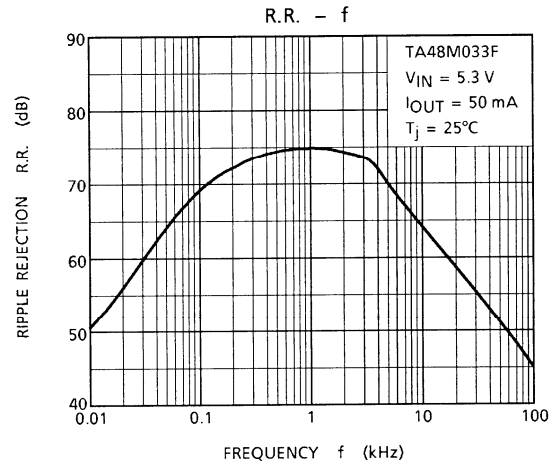
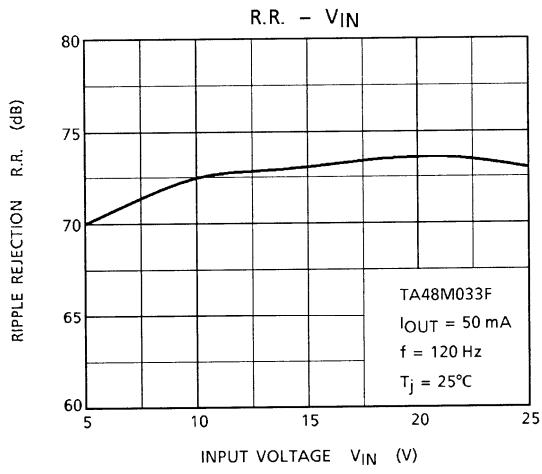

Package Dimensions

HSIP3-P-2.30B

Unit : mm

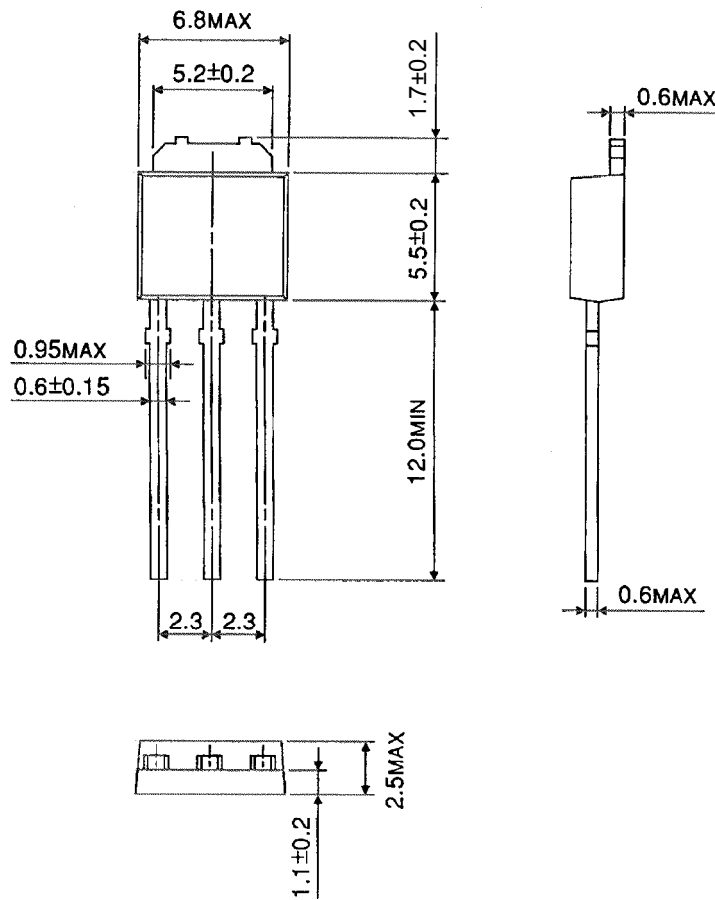

Weight: 0.36 g (typ.)

Package Dimensions

HSOP3-P-2.30A

Unit: mm

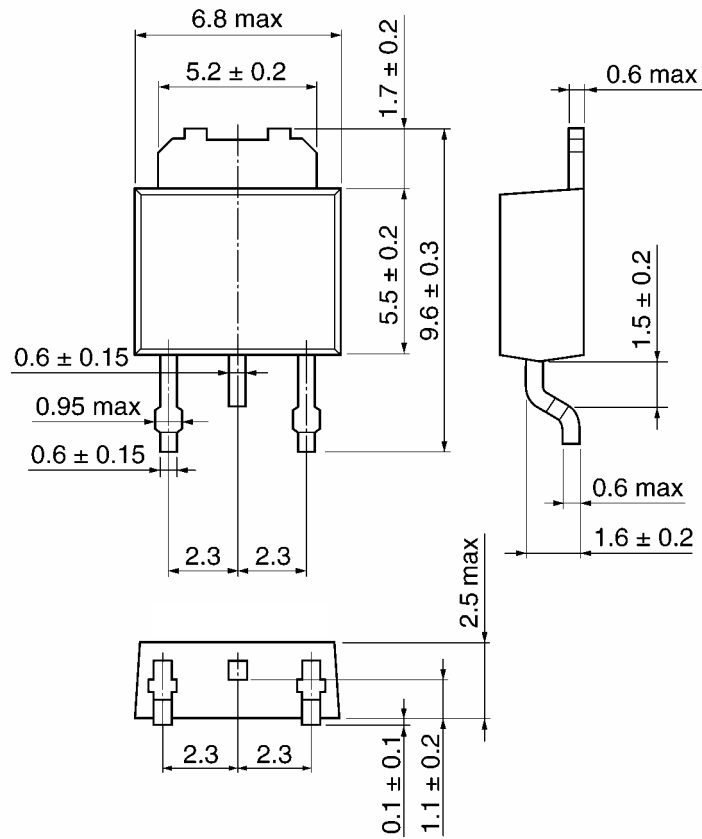

Weight: 0.36 g (typ.)

RESTRICTIONS ON PRODUCT USE

20070701-EN

- The information contained herein is subject to change without notice.
- TOSHIBA is continually working to improve the quality and reliability of its products. Nevertheless, semiconductor devices in general can malfunction or fail due to their inherent electrical sensitivity and vulnerability to physical stress. It is the responsibility of the buyer, when utilizing TOSHIBA products, to comply with the standards of safety in making a safe design for the entire system, and to avoid situations in which a malfunction or failure of such TOSHIBA products could cause loss of human life, bodily injury or damage to property.
In developing your designs, please ensure that TOSHIBA products are used within specified operating ranges as set forth in the most recent TOSHIBA products specifications. Also, please keep in mind the precautions and conditions set forth in the "Handling Guide for Semiconductor Devices," or "TOSHIBA Semiconductor Reliability Handbook" etc.
- The TOSHIBA products listed in this document are intended for usage in general electronics applications (computer, personal equipment, office equipment, measuring equipment, industrial robotics, domestic appliances, etc.). These TOSHIBA products are neither intended nor warranted for usage in equipment that requires extraordinarily high quality and/or reliability or a malfunction or failure of which may cause loss of human life or bodily injury ("Unintended Usage"). Unintended Usage include atomic energy control instruments, airplane or spaceship instruments, transportation instruments, traffic signal instruments, combustion control instruments, medical instruments, all types of safety devices, etc.. Unintended Usage of TOSHIBA products listed in this document shall be made at the customer's own risk.
- The products described in this document shall not be used or embedded to any downstream products of which manufacture, use and/or sale are prohibited under any applicable laws and regulations.
- The information contained herein is presented only as a guide for the applications of our products. No responsibility is assumed by TOSHIBA for any infringements of patents or other rights of the third parties which may result from its use. No license is granted by implication or otherwise under any patents or other rights of TOSHIBA or the third parties.
- Please contact your sales representative for product-by-product details in this document regarding RoHS compatibility. Please use these products in this document in compliance with all applicable laws and regulations that regulate the inclusion or use of controlled substances. Toshiba assumes no liability for damage or losses occurring as a result of noncompliance with applicable laws and regulations.