

**SEMITOP<sup>®</sup> 3**

## IGBT Module

**SK15GD065ET**

Preliminary Data

### Features

- Compact design
- One screw mounting
- Heat transfer and isolation through direct copper bonded aluminium oxide ceramic (DCB)
- Ultrafast NPT technology IGBT
- CAL technology FWD
- Integrated NTC temperature sensor

### Typical Applications

- Inverter

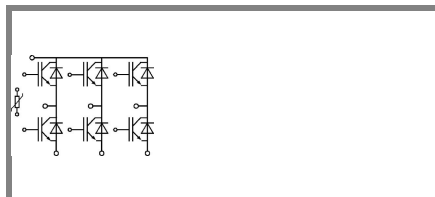

**GD-ET**

Absolute Maximum Ratings		$T_s = 25\text{ °C}$ , unless otherwise specified	
Symbol	Conditions	Values	Units
<b>IGBT</b>			
$V_{CES}$	$T_j = 25\text{ °C}$	600	V
$I_C$	$T_j = 125\text{ °C}$	$T_s = 25\text{ °C}$	20
		$T_s = 80\text{ °C}$	14
$I_{CRM}$	$I_{CRM} = 2 \times I_{Cnom}$	30	A
$V_{GES}$		$\pm 20$	V
$t_{psc}$	$V_{CC} = 300\text{ V}; V_{GE} \leq 20\text{ V}; T_j = 125\text{ °C}$ $V_{CES} < 600\text{ V}$	10	$\mu\text{s}$
<b>Inverse Diode</b>			
$I_F$	$T_j = 150\text{ °C}$	$T_s = 25\text{ °C}$	22
		$T_s = 80\text{ °C}$	15
$I_{FRM}$	$I_{FRM} = 2 \times I_{Fnom}$	30	A
<b>Module</b>			
$I_{t(RMS)}$			A
$T_{vj}$		-40 ... +150	$^{\circ}\text{C}$
$T_{stg}$		-40 ... +125	$^{\circ}\text{C}$
$V_{isol}$	AC, 1 min.	2500	V

Characteristics		$T_s = 25\text{ °C}$ , unless otherwise specified			
Symbol	Conditions	min.	typ.	max.	Units
<b>IGBT</b>					
$V_{GE(th)}$	$V_{GE} = V_{CE}, I_C = 0,4\text{ mA}$	3	4	5	V
$I_{CES}$	$V_{GE} = 0\text{ V}, V_{CE} = V_{CES}$	$T_j = 25\text{ °C}$		0,07	mA
		$T_j = 125\text{ °C}$			mA
$I_{GES}$	$V_{CE} = 0\text{ V}, V_{GE} = 20\text{ V}$	$T_j = 25\text{ °C}$		120	nA
		$T_j = 125\text{ °C}$			nA
$V_{CE0}$		$T_j = 25\text{ °C}$	1,2	1,3	V
		$T_j = 125\text{ °C}$	1,1	0,9	V
$r_{CE}$	$V_{GE} = 15\text{ V}$	$T_j = 25\text{ °C}$	80	120	$\text{m}\Omega$
		$T_j = 125\text{ °C}$	110		$\text{m}\Omega$
$V_{CE(sat)}$	$I_{Cnom} = 15\text{ A}, V_{GE} = 15\text{ V}$	$T_j = 25\text{ °C}_{chiplev.}$	2	2,5	V
		$T_j = 125\text{ °C}_{chiplev.}$	2,2		V
$C_{ies}$	$V_{CE} = 25, V_{GE} = 0\text{ V}$	$f = 1\text{ MHz}$	0,8		nF
$C_{oes}$			0,084		nF
$C_{res}$			0,052		nF
$t_{d(on)}$	$R_{Gon} = 125\ \Omega$	$V_{CC} = 300\text{ V}$ $I_{Cnom} = 10\text{ A}$	45		ns
$t_r$			40		ns
$E_{on}$	$R_{Goff} = 125\ \Omega$	$T_j = 125\text{ °C}$ $V_{GE} = \pm 15\text{ V}$	0,3		mJ
$t_{d(off)}$			340		ns
$t_f$			90		ns
$E_{off}$			0,22		mJ
$R_{th(j-s)}$	per IGBT			1,9	K/W

# SK15GD065ET

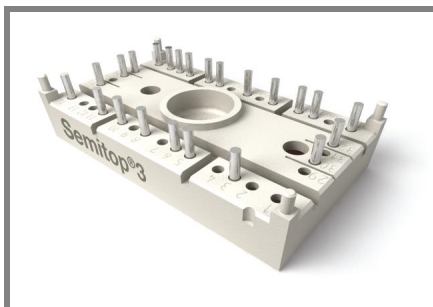

**SEMITOP<sup>®</sup> 3**

## IGBT Module

**SK15GD065ET**

Preliminary Data

### Features

- Compact design
- One screw mounting
- Heat transfer and isolation through direct copper bonded aluminium oxide ceramic (DCB)
- Ultrafast NPT technology IGBT
- CAL technology FWD
- Integrated NTC temperature sensor

### Typical Applications

- Inverter

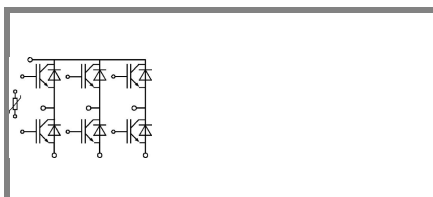

**GD-ET**

Characteristics			min.	typ.	max.	Units
Symbol	Conditions					
<b>Inverse Diode</b>						
$V_F = V_{EC}$	$I_{Fnom} = 10 \text{ A}; V_{GE} = 0 \text{ V}$	$T_j = 25 \text{ }^\circ\text{C}_{\text{chiplev.}}$		1,4	1,7	V
		$T_j = 125 \text{ }^\circ\text{C}_{\text{chiplev.}}$		1,4		V
$V_{F0}$		$T_j = 25 \text{ }^\circ\text{C}$		1	1,1	V
		$T_j = 125 \text{ }^\circ\text{C}$		0,9		V
$r_F$		$T_j = 25 \text{ }^\circ\text{C}$		45	60	mΩ
		$T_j = 125 \text{ }^\circ\text{C}$		50		mΩ
$I_{RRM}$	$I_{Fnom} = 10 \text{ A}$	$T_j = 125 \text{ }^\circ\text{C}$		11		A
$Q_{rr}$	$di/dt = -290 \text{ A}/\mu\text{s}$			1,1		μC
$E_{rr}$	$V_{CC} = 300\text{V}$			0,24		mJ
$R_{th(j-s)D}$	per diode				2,3	K/W
$M_s$	to heat sink		2,25		2,5	Nm
w				30		g
<b>Temperature sensor</b>						
$R_{100}$	$T_s = 100^\circ\text{C} (R_{25} = 5\text{k}\Omega)$			493±5%		Ω

This is an electrostatic discharge sensitive device (ESDS), international standard IEC 60747-1, Chapter IX.

This technical information specifies semiconductor devices but promises no characteristics. No warranty or guarantee expressed or implied is made regarding delivery, performance or suitability.

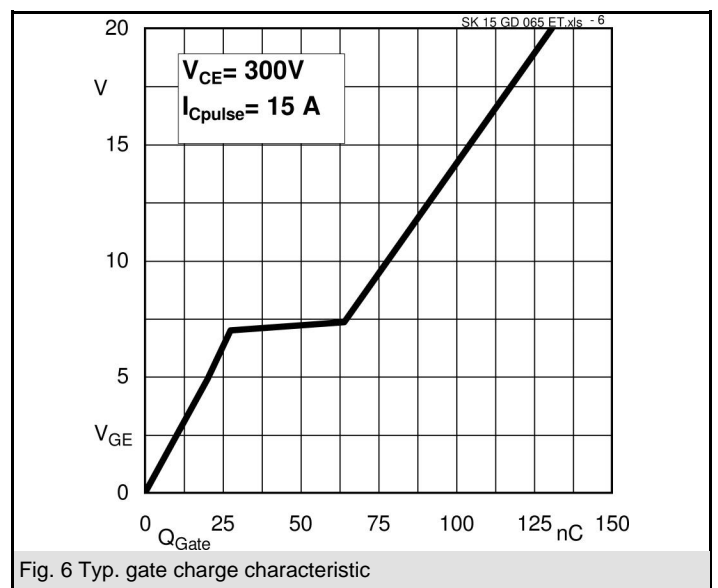
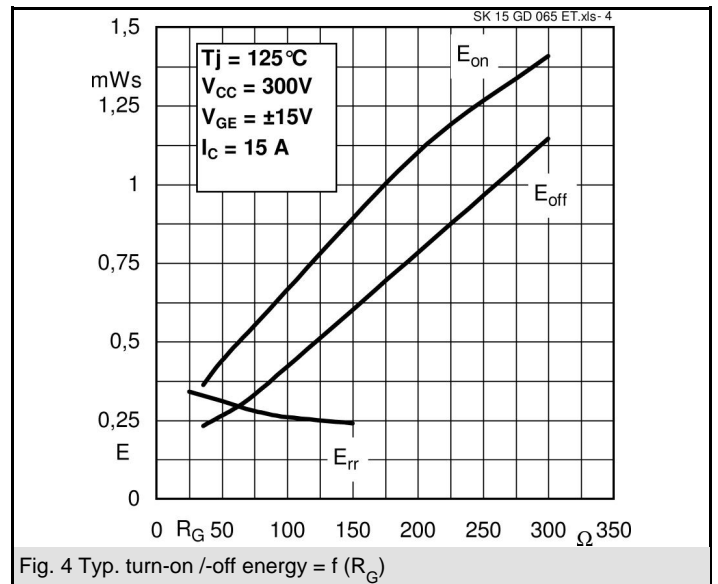
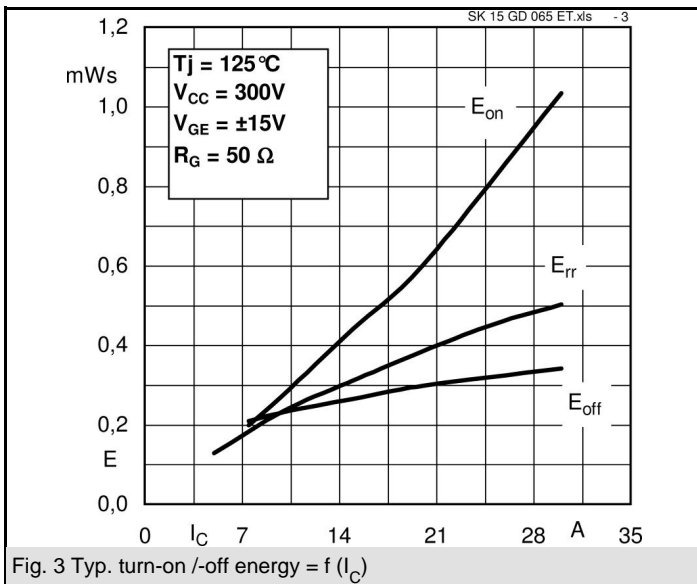
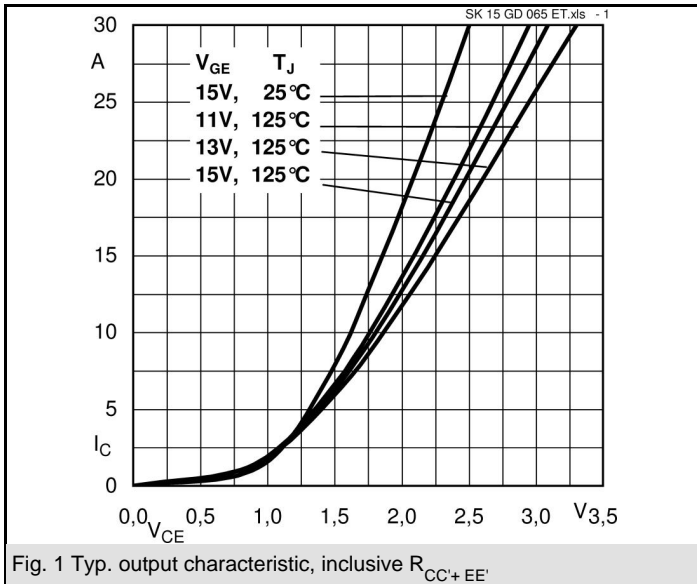

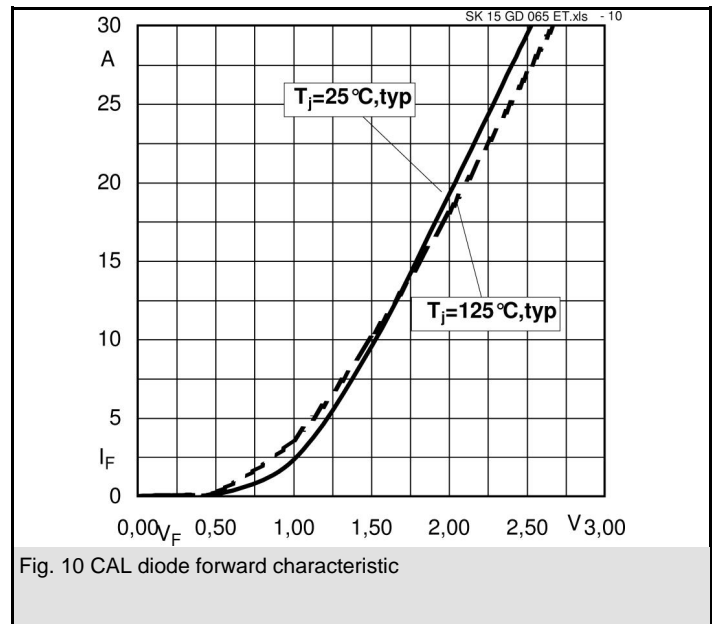
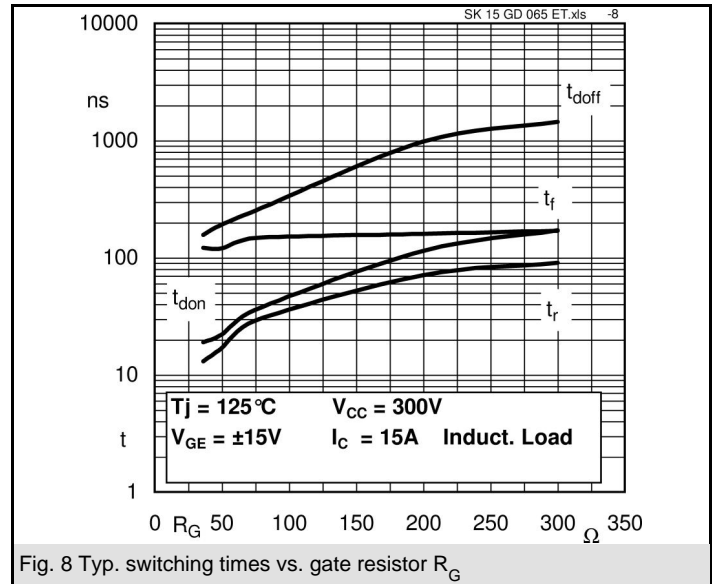
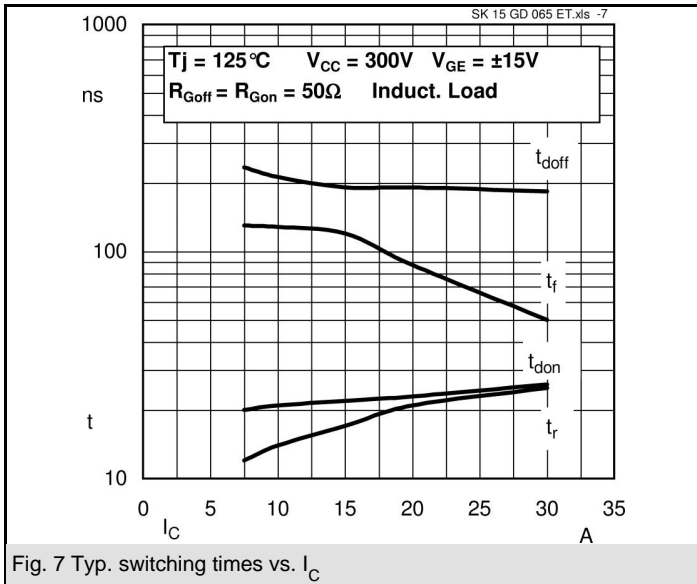

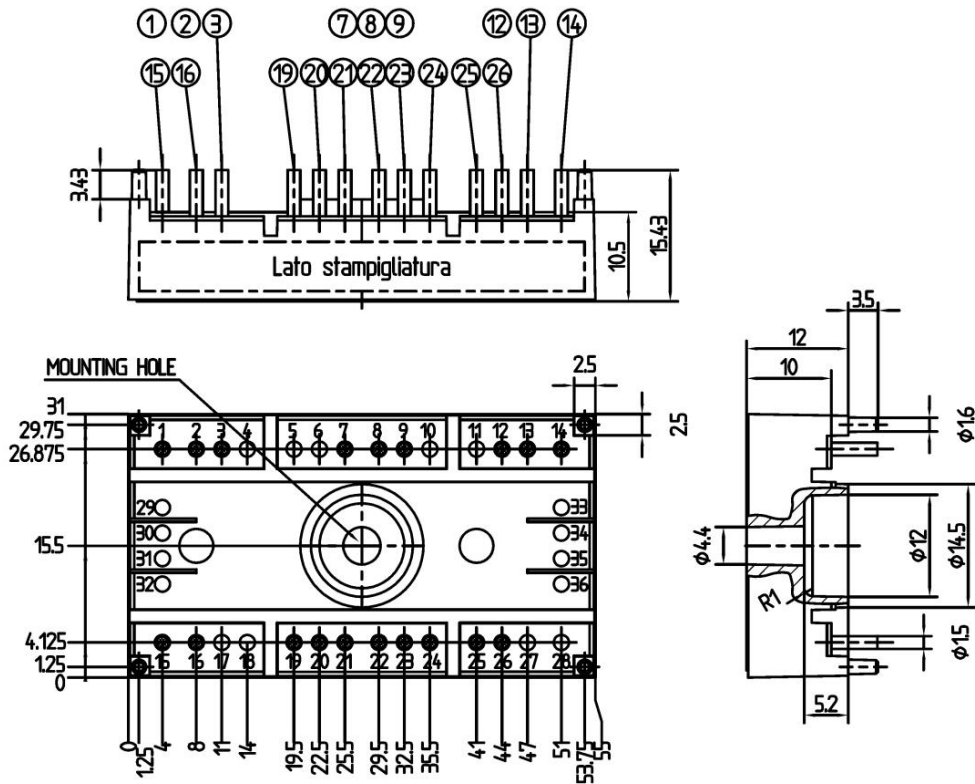

Case T52 (Suggested hole diameter, in the PCB, for solder pins and plastic mounting pins: 2mm)

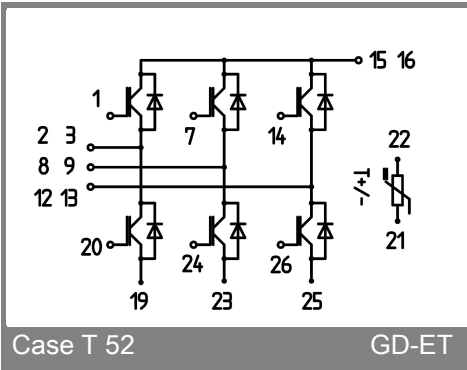

Case T 52

GD-ET