

# Single Phase Bridge Rectifier

## 1N4436 — 1N4438

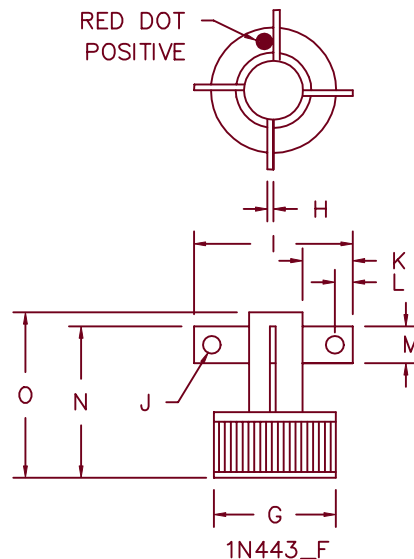

Note: Electrically Isolated

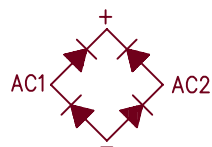
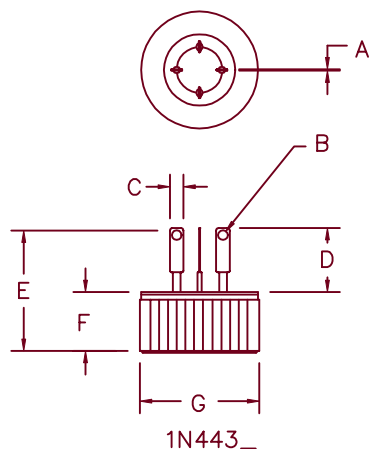
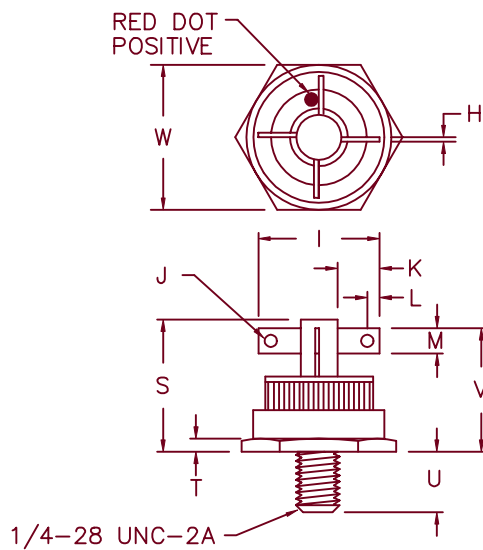
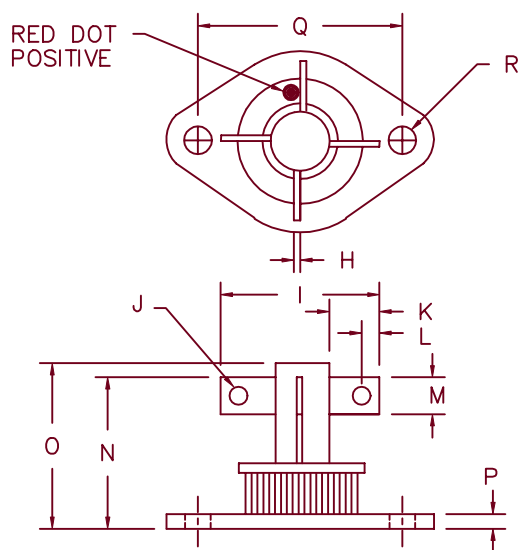

1N443\_FT ← For Parts w/o Flags Delete F → 1N443\_FS

Dim.	Inches		Millimeter		Notes
	Minimum	Maximum	Minimum	Maximum	
A	.018	.028	0.46	0.71	
B	---	.070 typ.	---	---	Dia.
C	---	.125 typ.	---	---	
D	.290	.330	7.37	8.38	
E	---	.825	---	20.95	
F	.390	.420	9.90	10.67	
G	.751	.755	19.07	19.18	
H	---	.032 typ.	---	---	
I	---	1.0	---	25.4	
J	---	.11 typ.	---	---	Dia.
K	.250	---	6.35	---	

Dim.	Inches		Millimeter		Notes
	Minimum	Maximum	Minimum	Maximum	
L	---	.125 Typ.	---	---	
M	---	.187 Typ.	---	---	
N	---	.830	---	21.08	
O	---	.930	---	23.62	
P	---	.135	---	3.43	
Q	1.177	1.197	29.90	30.40	
R	.151	.161	3.84	4.10	Dia.
S	---	1.20	---	30.48	
T	---	.125 typ.	---	---	
U	.340	.400	8.64	10.16	
V	---	1.10	---	27.94	
W	---	.875	---	22.83	

# 1N4436 – 1N4438

Microsemi Catalog Number	Repetitive Peak Reverse Voltage
1N4436	200V
1N4437	400V
1N4438	600V

- Glass Passivated Die
- Hermetically sealed
- Soft Recovery
- 160°C Junction temperature
- 2000VDC Isolation voltage

Electrical Characteristics		
DC forward current output	$I_o$ 10A	$T_c = 100^\circ\text{C}$ , $R_{\theta JC} = 1.5^\circ\text{C/W}$
Maximum Surge Current	$I_{FSM}$ 100 Amps	
Maximum $I^2t$ For Fusing	$I^2t$ 40A <sup>2</sup> s	
Max. Peak Forward Voltage per leg	$V_{FM}$ 1.2 Volts	$I_{FM} = 10\text{A}$ ; $T_J = 25^\circ\text{C}$
Max. Peak Reverse Current	$I_{RM}$ 10 $\mu\text{A}$	$V_{RRM}$ , $T_J = 25^\circ\text{C}$
Max. Peak Reverse Current	$I_{RM}$ 1.0 mA	$V_{RRM}$ , $T_J = 150^\circ\text{C}$

Thermal and Mechanical Characteristics		
Storage temp range	$T_{STG, TOP}$	$-65^\circ\text{C}$ to $+160^\circ\text{C}$
Max thermal resistance	$R_{\theta JC}$	1.5°C/W junction to case

# 1N4436-1N4438

Figure 1  
Typical Forward Characteristics

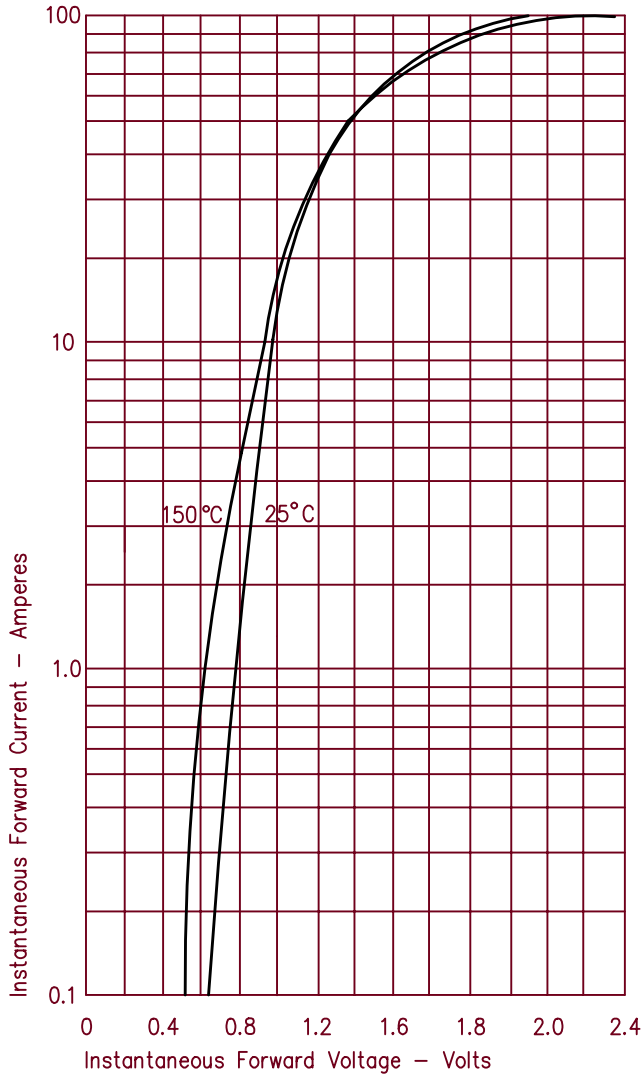

Figure 3  
Forward Current Derating

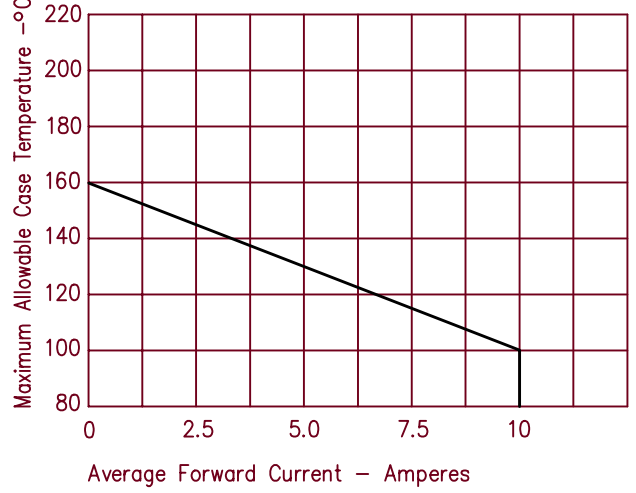
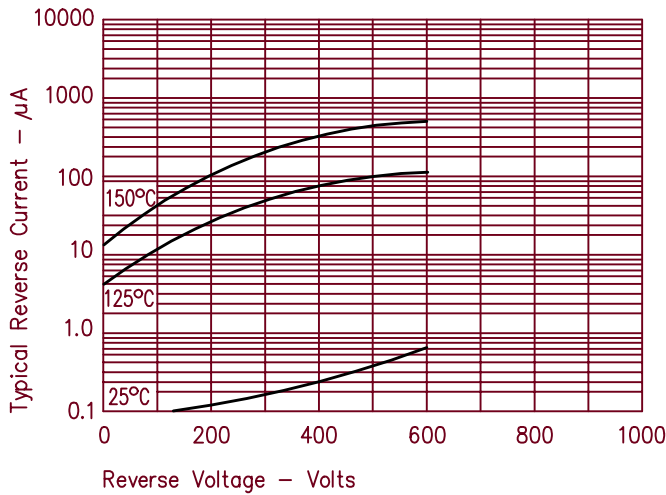

Figure 2  
Typical Reverse Characteristics



This datasheet has been download from:

[www.datasheetcatalog.com](http://www.datasheetcatalog.com)

Datasheets for electronics components.