

PRELIMINARY SPEC

Part Number: WP7114RWC/A

WHITE



ATTENTION
OBSERVE PRECAUTIONS
FOR HANDLING
ELECTROSTATIC
DISCHARGE
SENSITIVE
DEVICES

Features

- LOW POWER CONSUMPTION.
- POPULAR T-1 3/4 DIAMETER PACKAGE.
- GENERAL PURPOSE LEADS.
- RELIABLE AND RUGGED.
- LONG LIFE - SOLID STATE RELIABILITY.
- AVAILABLE ON TAPE AND REEL.
- MOISTURE SENSITIVITY LEVEL : LEVEL 1.
- ELECTROSTATIC DISCHARGE THRESHOLD (HBM):1000V.
- TYP. COLOR TEMPERATURE:6500K.
- COLOR COORDINATES:X=0.33,Y=0.34 ACC. TO CIE1931(WHITE).
- OPTICAL EFFICIENCY:6 lm/W(TYP.)
- COLOR REPRODUCTION INDEX:80.
- RoHS COMPLIANT.

Description

The source color devices are made with InGaN on SiC Light Emitting Diode.

Static electricity and surge damage the LEDs.

It is recommended to use a wrist band or anti-electrostatic glove when handling the LEDs.

All devices, equipment and machinery must be electrically grounded.

Applications

- Marker lights
- Furniture lighting
- Outdoor displays
- Optical indicators
- Signal and symbol luminaire
- Marker lights (e.g. steps, exit ways, etc.)
- Lighting for special effects (e.g. starry sky)
- Substitute for miniature flashlight

Package Dimensions

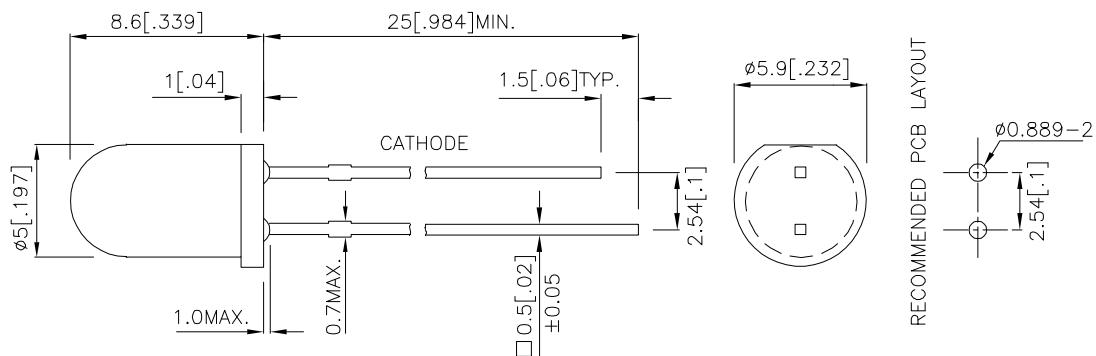

Notes:

1. All dimensions are in millimeters (inches).
2. Tolerance is $\pm 0.25(0.01)$ unless otherwise noted.
3. Lead spacing is measured where the leads emerge from the package.
4. Specifications are subject to change without notice.

Selection Guide

Part No.	Dice	Lens Type	Luminous Intensity ^{Note2} Iv(mcd) @ 20mA		Φ_v (mlm) ^{Note3} @ 20mA	Viewing Angle ^{Note1}
			Min.	Typ.	Typ.	2 θ 1/2
WP7114RWC/A	WHITE (InGaN)	WATER CLEAR	480	1200	400	20°

Absolute Maximum Ratings at T_A=25°C

Parameter	Symbol	Value	Unit
Power dissipation	P _t	114	mW
Reverse Voltage	V _R	5	V
Junction temperature	T _J	110	°C
Operating Temperature	T _{op}	-40 To +85	°C
Storage Temperature	T _{stg}	-40 To +100	°C
DC Forward Current	I _F	30	mA
Peak Forward Current ^{Note4}	I _{FM}	100	mA
Thermal resistance Junction/ambient ^{Note5}	R _{th JA}	350	°C/W
Junction/solder point	R _{th JS}	130	°C/W

Notes:

1. θ 1/2 is the angle from optical centerline where the luminous intensity is 1/2 the optical centerline value.
- 2.Luminous intensity is measured by a current pulse of 10ms at a tolerance of \pm 15%.
- 3.The typical data of Luminous Flux can only reflect statistical figures, actual parameters of individual product could differ from the typical data.
For the purpose of product enhancement, the typical data is subject to change without prior notice.
- 4.1/10 Duty Cycle, 0.1ms Pulse Width.
- 5.R_{th}(J-A) Results from mounting on PC board FR4 (pad size \geq 16 mm² per pad),

Electrical / Optical Characteristics at T_A=25°C

Parameter	Symbol	Value	Unit
Chromaticity coordinate x acc.to CIE1931 I _F =20mA [Typ.]	X ^{Note1}	0.33	-
Chromaticity coordinate y acc.to CIE1931 I _F =20mA [Typ.]	Y ^{Note1}	0.34	-
Forward Voltage I _F =20mA [Min.]	V _F ^{Note2}	2.7	V
Forward Voltage I _F =20mA [Typ.]		3.3	
Forward Voltage I _F =20mA [Max.]		3.8	
Reverse Current (V _R =5V) [Typ.]	I _R	0.01	μ A
Reverse Current (V _R =5V) [Max.]		10	
Temperature coefficient of x I _F =20mA, -10°C \leq T \leq 100°C [Typ.]	TC _x	-0.1	10 ⁻³ /°C
Temperature coefficient of y I _F =20mA, -10°C \leq T \leq 100°C [Typ.]	TC _y	-0.2	10 ⁻³ /°C
Temperature coefficient of V _F I _F =20mA, -10°C \leq T \leq 100°C [Typ.]	TC _v	-2.5	mV/°C

Notes:

- 1.Chromaticity coordinates are measured by a current pulse of 20ms with a tolerance of \pm 0.01 in X and Y color coordinates.
- 2.Forward voltage is measured with a current pulse of 10ms at a tolerance of \pm 0.1V.

Brightness codes

Code.	Luminous Intensity ^{Note1} Iv(mcd) @ 20mA		Φ_v (mlm) ^{Note2} @ 20mA
	Min.	Max.	Typ.
S	480	750	200
T	650	1100	300
U	900	1500	400
V	1200	1800	500
W	1500	2100	600
X	1800	2500	750
Y	2200	3000	900
Z	2500	3300	1000
ZA	2800	3800	1200
ZB	3300	4500	1400
ZC	3800	5500	1600

Notes:

- Luminous intensity is measured by a current pulse of 10ms at a tolerance of $\pm 15\%$.
- The typical data of Luminous Flux can only reflect statistical figures, actual parameters of individual product could differ from the typical data. For the purpose of product enhancement, the typical data is subject to change without prior notice.

White

WP7114RWC/A

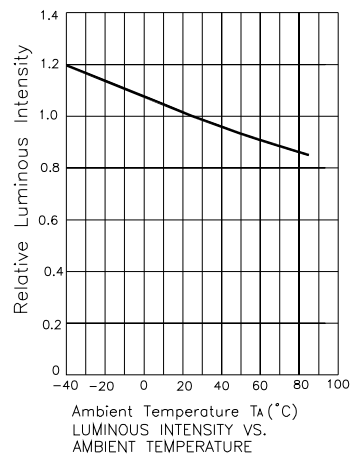
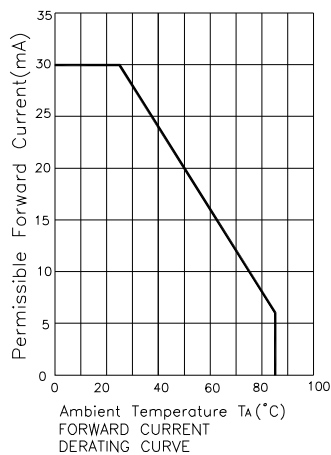
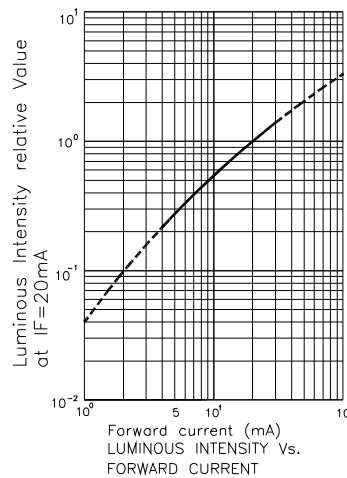
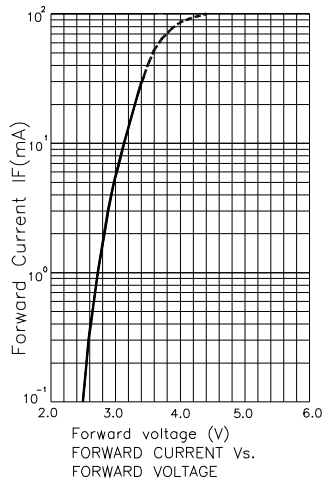

White

WP7114RWC/A

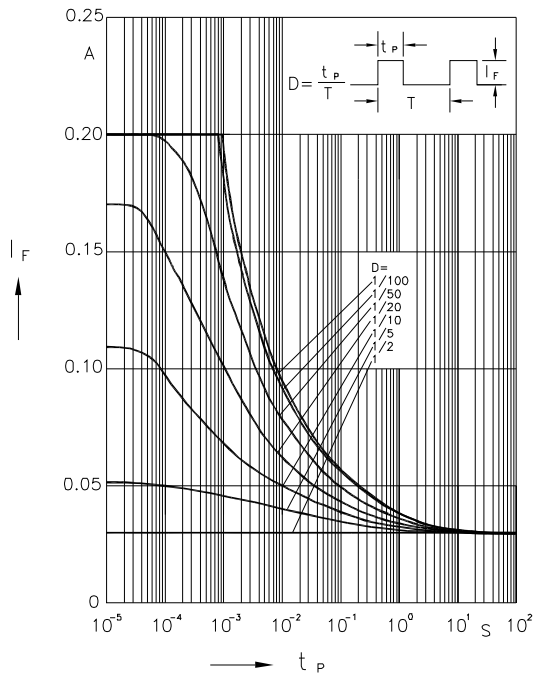

Permissible Pulse Handling Capability
Duty cycle $D = \text{parameter}$, $T_A = 25^\circ\text{C}$

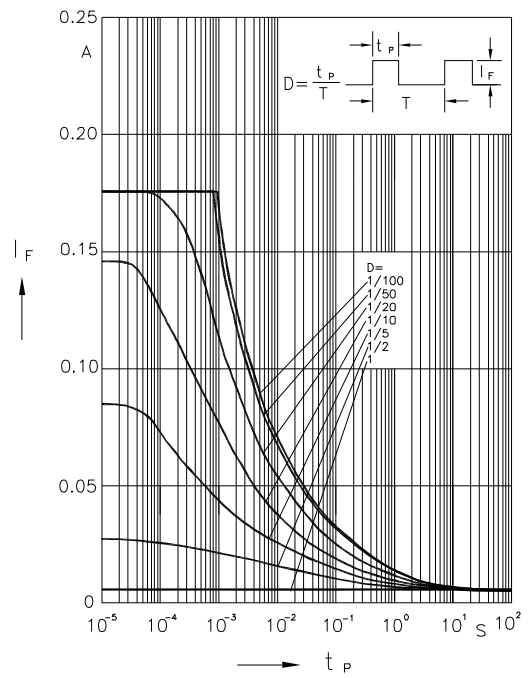

Permissible Pulse Handling Capability
Duty cycle $D = \text{parameter}$, $T_A = 85^\circ\text{C}$

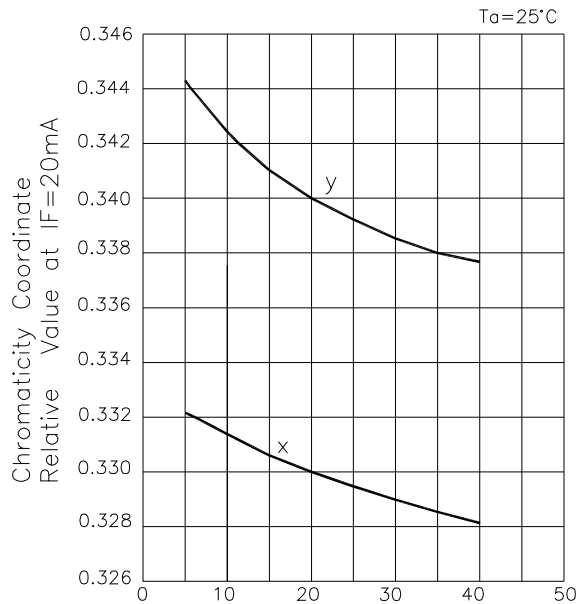

Forward Current(mA)
Chromaticity Coordinate Shift Vs.
Forward Current

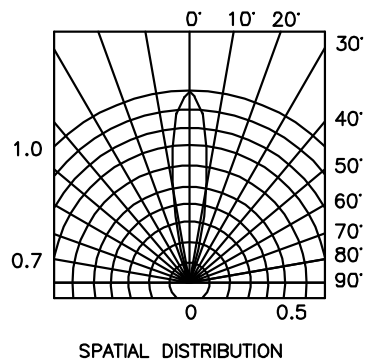
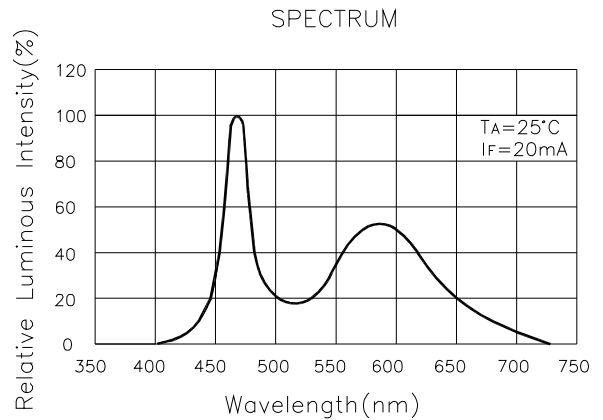

SPATIAL DISTRIBUTION

Color Codes

WP7114RWC/A

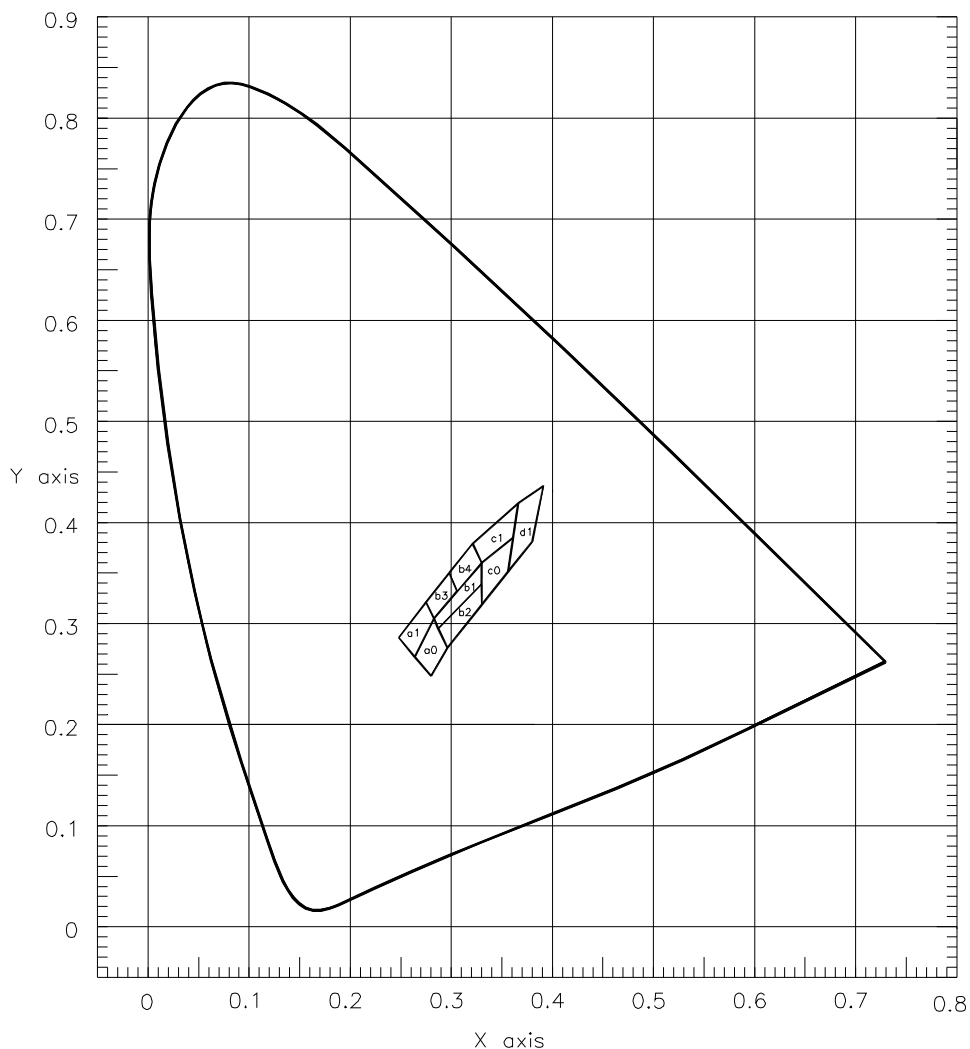

a1				
X	0.248	0.275	0.283	0.264
Y	0.286	0.321	0.305	0.267
b1				
X	0.283	0.330	0.330	0.287
Y	0.305	0.360	0.339	0.295
c1				
X	0.321	0.366	0.361	0.330
Y	0.379	0.419	0.385	0.360

a0				
X	0.264	0.283	0.296	0.280
Y	0.267	0.305	0.276	0.248
b2				
X	0.287	0.330	0.330	0.296
Y	0.295	0.339	0.318	0.276
c0				
X	0.330	0.361	0.356	0.330
Y	0.360	0.385	0.351	0.318

b3				
X	0.275	0.298	0.306	0.283
Y	0.321	0.350	0.332	0.305
b4				
X	0.298	0.321	0.330	0.306
Y	0.350	0.379	0.360	0.332
d1				
X	0.366	0.391	0.380	0.356
Y	0.419	0.436	0.381	0.351

Ta=25°, IF=20mA

Measurement Uncertainty of the Color Coordinates: +/-0.01

WP7114RWC/A

Wave Soldering Profile For Lead-free Through-hole LED.

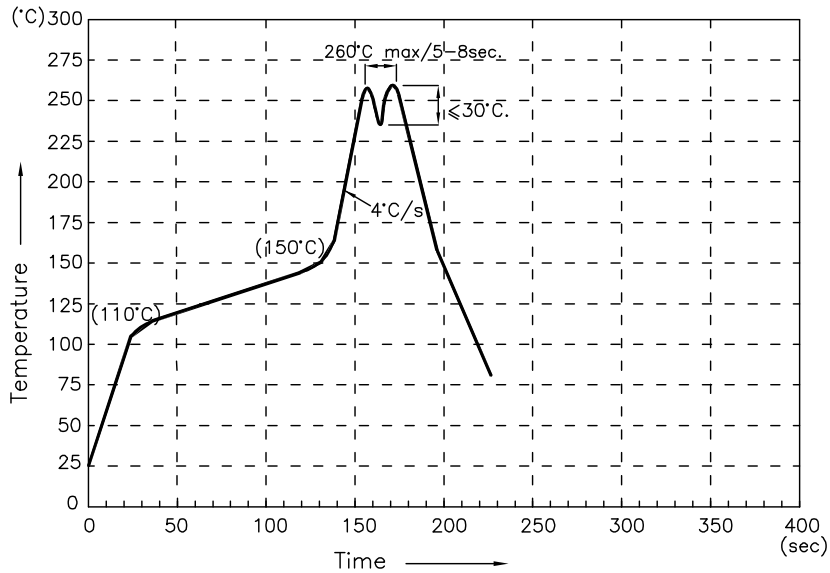

NOTES:

- 1.Recommend the wave temperature 245°C~260°C.The maximum soldering temperature should be less than 260°C.
- 2.Do not apply stress on epoxy resins when temperature is over 85 degree°C.
- 3.The soldering profile apply to the lead free soldering (Sn/Cu/Ag alloy).
- 4.No more than once.

Recommended Soldering Pattern (Units : mm; Tolerance: ±0.1)

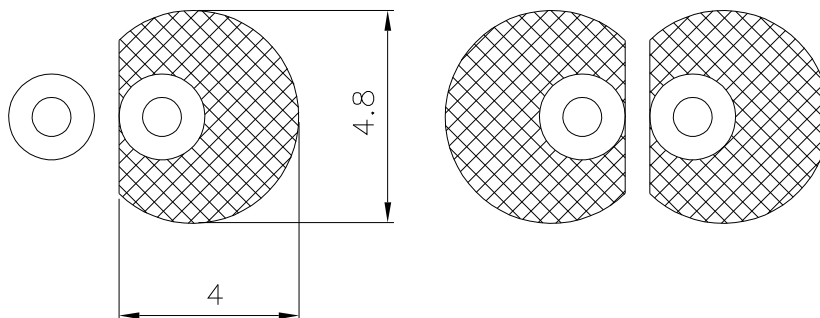

PACKING & LABEL SPECIFICATIONS

WP7114RWC/A

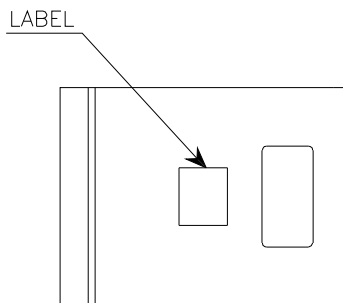
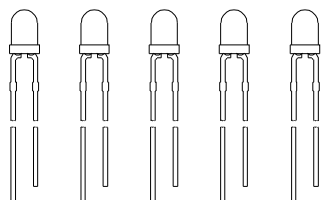

500PCS/BAG



20K / 9# BOX

OUTSIDE LABEL

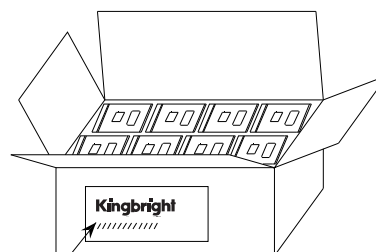
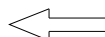

OUTSIDE LABEL

10K / 5# BOX

Kingbright	
Q.C.	
<div style="display: flex; justify-content: space-between;"> TYPE NO : WP7114XXX <div style="border: 1px solid black; border-radius: 50%; padding: 2px; text-align: center;"> QC xxx-xx-xxxx PASSED </div> </div>	
QUANTITY : 500 pcs	
S/N : xxx CODE: XX	
LOT NO :  <small>xxxxxxxxxx</small>	
RoHS Compliant	