

# MOS INTEGRATED CIRCUIT

## $\mu$ PD44321181, 44321361

### 32M-BIT ZEROSB™ SRAM FLOW THROUGH OPERATION

#### Description

The  $\mu$ PD44321181 is a 2,097,152-word by 18-bit and the  $\mu$ PD44321361 is a 1,048,576-word by 36-bit ZEROSB static RAM fabricated with advanced CMOS technology using full CMOS six-transistor memory cell.

The  $\mu$ PD44321181 and  $\mu$ PD44321361 are optimized to eliminate dead cycles for read to write, or write to read transitions. These ZEROSB static RAMs integrate unique synchronous peripheral circuitry, 2-bit burst counter and output buffer as well as SRAM core. All input registers are controlled by a positive edge of the single clock input (CLK).

The  $\mu$ PD44321181 and  $\mu$ PD44321361 are suitable for applications which require synchronous operation, high speed, low voltage, high density and wide bit configuration, such as buffer memory.

ZZ has to be set LOW at the normal operation. When ZZ is set HIGH, the SRAM enters Power Down State ("Sleep"). In the "Sleep" state, the SRAM internal state is preserved. When ZZ is set LOW again, the SRAM resumes normal operation.

The  $\mu$ PD44321181 and  $\mu$ PD44321361 are packaged in 100-pin PLASTIC LQFP with a 1.4 mm package thickness for high density and low capacitive loading.

#### Features

- Low voltage core supply:  $V_{DD} = 3.3 \pm 0.165 \text{ V} / 2.5 \pm 0.125 \text{ V}$
- Synchronous operation
- 100 percent bus utilization
- Internally self-timed write control
- Burst read / write : Interleaved burst and linear burst sequence
- Fully registered inputs and outputs for flow through operation
- All registers triggered off positive clock edge
- 3.3V or 2.5V LVTTL Compatible : All inputs and outputs
- Fast clock access time : 7.5 ns (117 MHz)
- Asynchronous output enable : /G
- Burst sequence selectable : MODE
- Sleep mode : ZZ (ZZ = Open or Low : Normal operation)
- Separate byte write enable : /BW1 to /BW4 ( $\mu$ PD44321361)  
/BW1 and /BW2 ( $\mu$ PD44321181)
- Three chip enables for easy depth expansion
- Common I/O using three state outputs

The information in this document is subject to change without notice. Before using this document, please confirm that this is the latest version.  
Not all products and/or types are available in every country. Please check with NEC Electronics sales representative for availability and additional information.

★ Ordering Information

Part number	Access Time ns	Clock Frequency MHz	Core Supply Voltage V	I/O Interface	Package
μPD44321181GF-A75	7.5	117	3.3 ± 0.165	3.3 V or 2.5 V LVTTTL	100-pin PLASTIC LQFP (14 x 20)
			2.5 ± 0.125	2.5 V LVTTTL	
μPD44321361GF-A75	7.5	117	3.3 ± 0.165	3.3 V or 2.5 V LVTTTL	
			2.5 ± 0.125	2.5 V LVTTTL	

Pin Configurations

/xxx indicates active low signal.

100-pin PLASTIC LQFP (14 × 20)  
[μPD44321181GF]

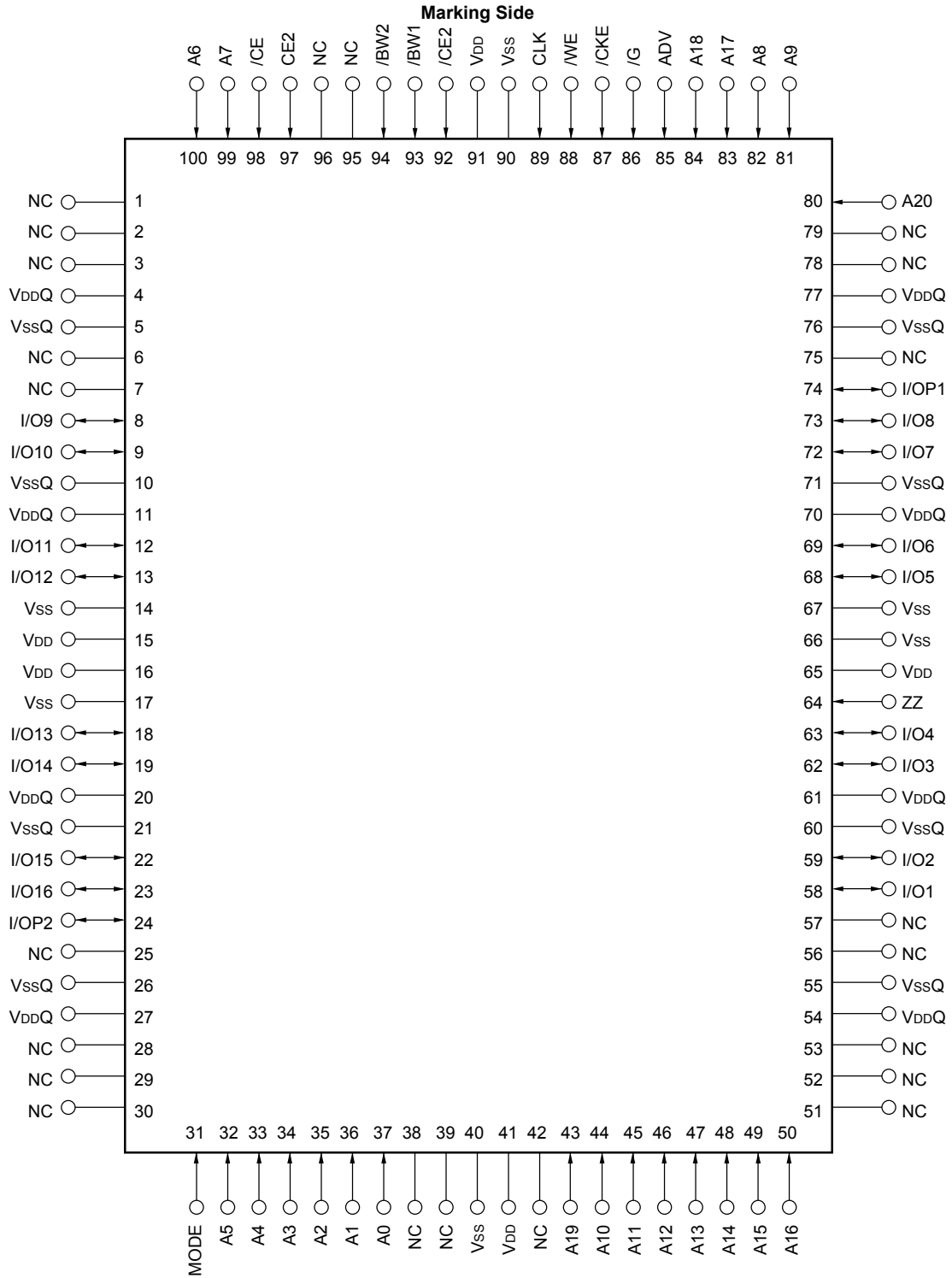

**Remark** Refer to **Package Drawing** for the 1-pin index mark.

## Pin Identifications

[ $\mu$ PD44321181GF]

Symbol	Pin No.	Description
A0 to A20	37, 36, 35, 34, 33, 32, 100, 99, 82, 81, 44, 45, 46, 47, 48, 49, 50, 83, 84, 43, 80	Synchronous Address Input
I/O1 to I/O16	58, 59, 62, 63, 68, 69, 72, 73, 8, 9, 12, 13, 18, 19, 22, 23	Synchronous Data In, Synchronous / Asynchronous Data Out
I/OP1, I/OP2	74, 24	Synchronous Data In (Parity), Synchronous / Asynchronous Data Out (Parity)
ADV	85	Synchronous Address Load / Advance Input
/CE, CE2, /CE2	98, 97, 92	Synchronous Chip Enable Input
/WE	88	Synchronous Write Enable Input
/BW1, /BW2	93, 94	Synchronous Byte Write Enable Input
/G	86	Asynchronous Output Enable Input
CLK	89	Clock Input
/CKE	87	Synchronous Clock Enable Input
MODE	31	Asynchronous Burst Sequence Select Input Have to tied to V <sub>DD</sub> or V <sub>SS</sub> during normal operation
ZZ	64	Asynchronous Power Down State Input
V <sub>DD</sub>	15, 16, 41, 65, 91	Power Supply
V <sub>SS</sub>	14, 17, 40, 66, 67, 90	Ground
V <sub>DDQ</sub>	4, 11, 20, 27, 54, 61, 70, 77	Output Buffer Power Supply
V <sub>SSQ</sub>	5, 10, 21, 26, 55, 60, 71, 76	Output Buffer Ground
NC	1, 2, 3, 6, 7, 25, 28, 29, 30, 38, 39, 42, 51, 52, 53, 56, 57, 75, 78, 79, 95, 96	No Connection

100-pin PLASTIC LQFP (14 × 20)  
[μPD44321361GF]

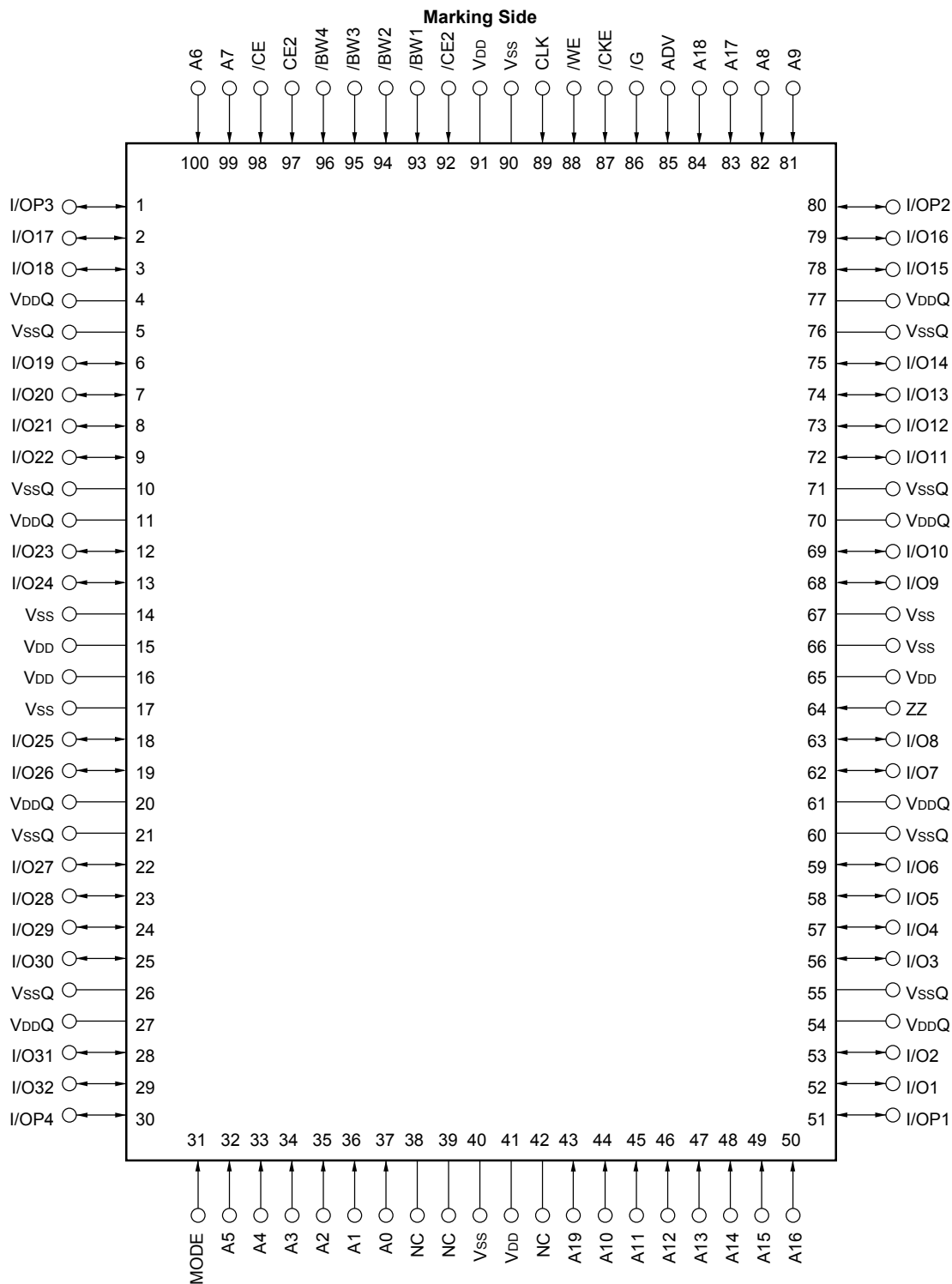

**Remark** Refer to **Package Drawing** for the 1-pin index mark.

## Pin Identifications

[ $\mu$ PD44321361GF]

Symbol	Pin No.	Description
A0 to A19	37, 36, 35, 34, 33, 32, 100, 99, 82, 81, 44, 45, 46, 47, 48, 49, 50, 83, 84, 43	Synchronous Address Input
I/O1 to I/O32	52, 53, 56, 57, 58, 59, 62, 63, 68, 69, 72, 73, 74, 75, 78, 79, 2, 3, 6, 7, 8, 9, 12, 13, 18, 19, 22, 23, 24, 25, 28, 29	Synchronous Data In, Synchronous / Asynchronous Data Out
I/OP1 to I/OP4	51, 80, 1, 30	Synchronous Data In (Parity), Synchronous / Asynchronous Data Out (Parity)
ADV	85	Synchronous Address Load / Advance Input
/CE, CE2, /CE2	98, 97, 92	Synchronous Chip Enable Input
/WE	88	Synchronous Write Enable Input
/BW1 to /BW4	93, 94, 95, 96	Synchronous Byte Write Enable Input
/G	86	Asynchronous Output Enable Input
CLK	89	Clock Input
/CKE	87	Synchronous Clock Enable Input
MODE	31	Asynchronous Burst Sequence Select Input Have to tied to $V_{DD}$ or $V_{SS}$ during normal operation
ZZ	64	Asynchronous Power Down State Input
$V_{DD}$	15, 16, 41, 65, 91	Power Supply
$V_{SS}$	14, 17, 40, 66, 67, 90	Ground
$V_{DDQ}$	4, 11, 20, 27, 54, 61, 70, 77	Output Buffer Power Supply
$V_{SSQ}$	5, 10, 21, 26, 55, 60, 71, 76	Output Buffer Ground
NC	38, 39, 42	No Connection

Block Diagrams

[μPD44321181]

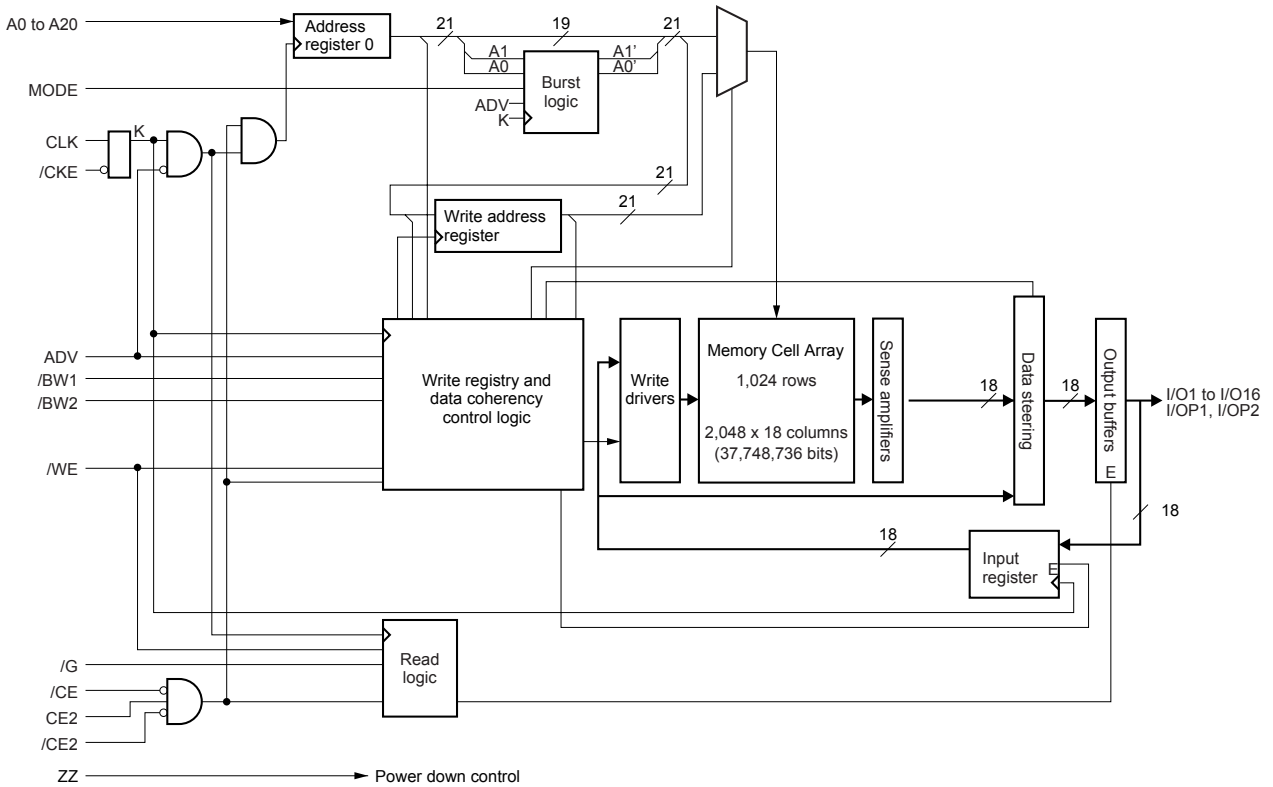

Burst Sequence

[μPD44321181]

Interleaved Burst Sequence Table (MODE = V<sub>DD</sub>)

External Address	A20 to A2, A1, A0
1st Burst Address	A20 to A2, A1, /A0
2nd Burst Address	A20 to A2, /A1, A0
3rd Burst Address	A20 to A2, /A1, /A0

Linear Burst Sequence Table (MODE = V<sub>SS</sub>)

External Address	A20 to A2, 0, 0	A20 to A2, 0, 1	A20 to A2, 1, 0	A20 to A2, 1, 1
1st Burst Address	A20 to A2, 0, 1	A20 to A2, 1, 0	A20 to A2, 1, 1	A20 to A2, 0, 0
2nd Burst Address	A20 to A2, 1, 0	A20 to A2, 1, 1	A20 to A2, 0, 0	A20 to A2, 0, 1
3rd Burst Address	A20 to A2, 1, 1	A20 to A2, 0, 0	A20 to A2, 0, 1	A20 to A2, 1, 0

[μPD44321361]

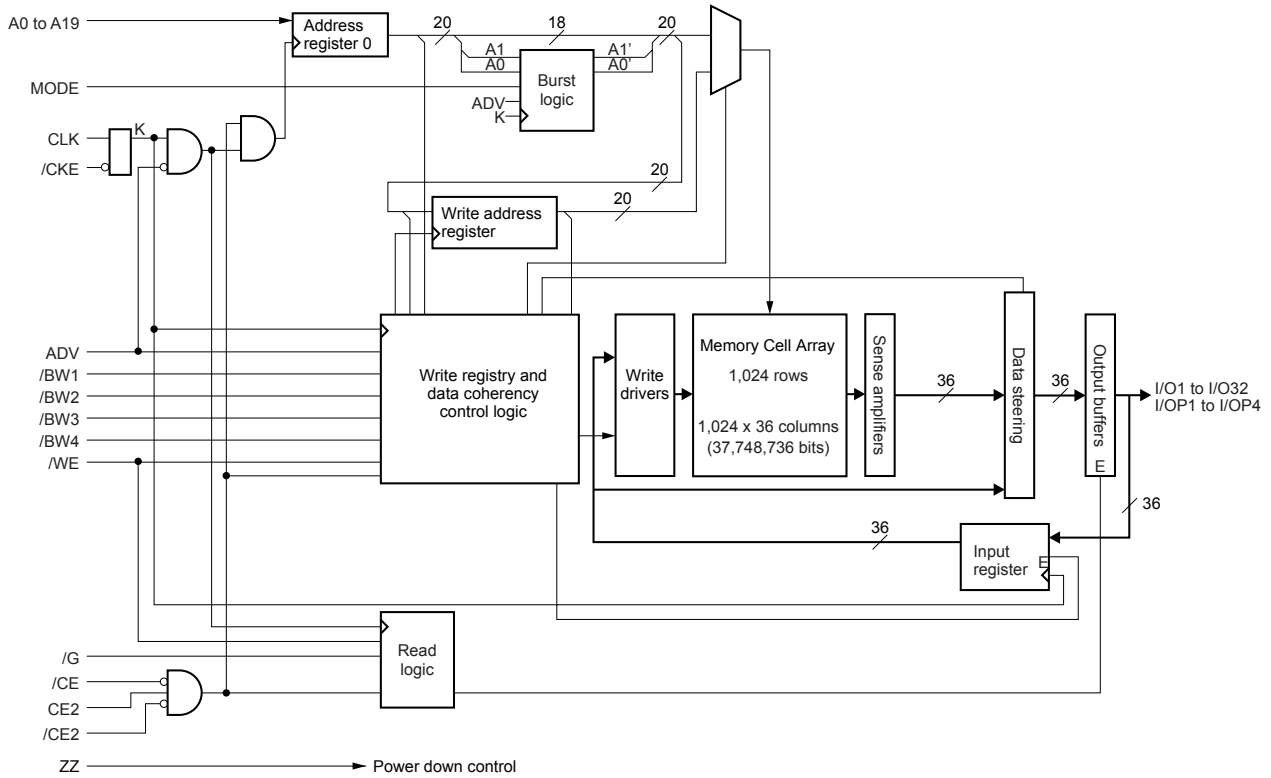

**Burst Sequence**

[μPD44321361]

**Interleaved Burst Sequence Table (MODE = V<sub>DD</sub>)**

External Address	A19 to A2, A1, A0
1st Burst Address	A19 to A2, A1, /A0
2nd Burst Address	A19 to A2, /A1, A0
3rd Burst Address	A19 to A2, /A1, /A0

**Linear Burst Sequence Table (MODE = V<sub>SS</sub>)**

External Address	A19 to A2, 0, 0	A19 to A2, 0, 1	A19 to A2, 1, 0	A19 to A2, 1, 1
1st Burst Address	A19 to A2, 0, 1	A19 to A2, 1, 0	A19 to A2, 1, 1	A19 to A2, 0, 0
2nd Burst Address	A19 to A2, 1, 0	A19 to A2, 1, 1	A19 to A2, 0, 0	A19 to A2, 0, 1
3rd Burst Address	A19 to A2, 1, 1	A19 to A2, 0, 0	A19 to A2, 0, 1	A19 to A2, 1, 0



State Diagram

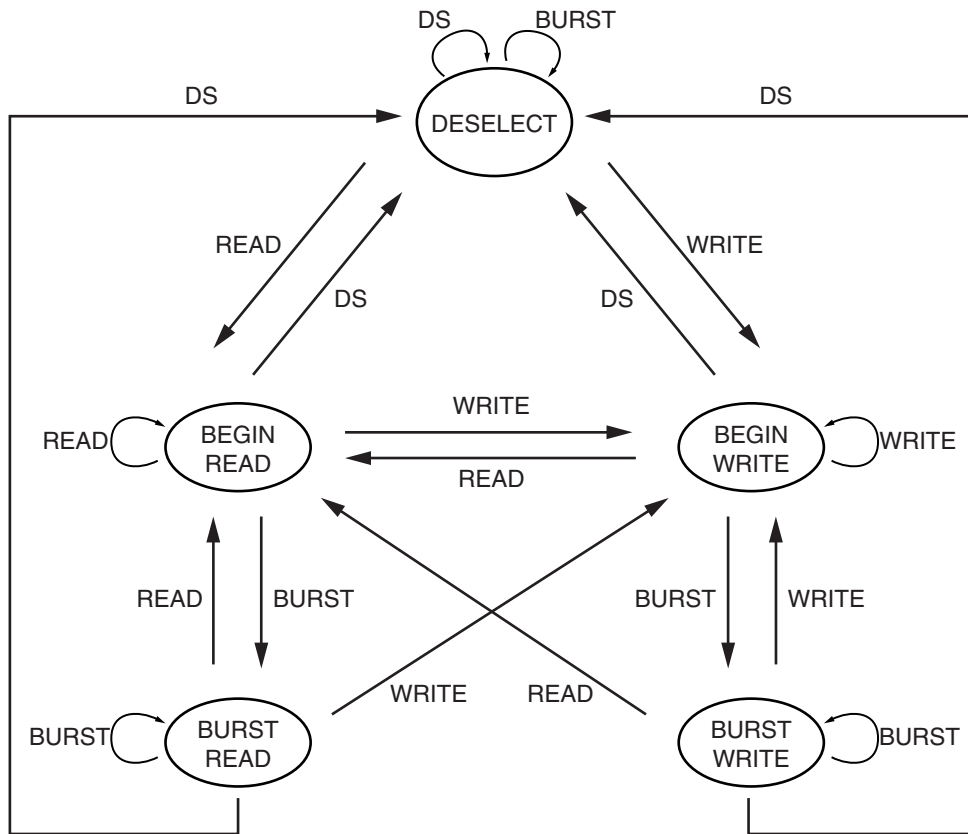

Command	Operation
DS	Deselect
Read	New Read
Write	New Write
Burst	Burst Read, Burst Write or Continue Deselect

- Remarks**
1. States change on the rising edge of the clock.
  2. A Stall or Ignore Clock Edge cycle is not shown in the above diagram. This is because /CKE HIGH only blocks the clock (CLK) input and does not change the state of the device.

**Asynchronous Truth Table**

Operation	/G	I/O
Read Cycle	L	Data-Out
Read Cycle	H	High-Z
Write Cycle	×	High-Z, Data-In
Deselected	×	High-Z

**Remark** × : don't care

**Synchronous Truth Table**

Operation	/CE	CE2	/CE2	ADV	/WE	/BWs	/CKE	CLK	I/O	Address	Note
Deselected	H	×	×	L	×	×	L	L → H	High-Z	None	1
Deselected	×	L	×	L	×	×	L	L → H	High-Z	None	1
Deselected	×	×	H	L	×	×	L	L → H	High-Z	None	1
Continue Deselected	×	×	×	H	×	×	L	L → H	High-Z	None	1
Read Cycle / Begin Burst	L	H	L	L	H	×	L	L → H	Data-Out	External	
Read Cycle / Continue Burst	×	×	×	H	×	×	L	L → H	Data-Out	Next	
Write Cycle / Begin Burst	L	H	L	L	L	L	L	L → H	Data-In	External	
Write Cycle / Continue Burst	×	×	×	H	×	L	L	L → H	Data-In	Next	
Write Cycle / Write Abort	L	H	L	L	L	H	L	L → H	High-Z	External	
Write Cycle / Write Abort	×	×	×	H	×	H	L	L → H	High-Z	Next	
Stall / Ignore Clock Edge	×	×	×	×	×	×	H	L → H	–	Current	2

- Notes**
1. Deselect status is held until new "Begin Burst" entry.
  2. If an Ignore Clock Edge command occurs during a read operation, the I/O bus will remain active (Low impedance). If it occurs during a write cycle, the bus will remain High impedance. No write operation will be performed during the Ignore Clock Edge cycle.

- Remarks**
1. × : don't care
  2. /BWs = L means any one or more byte write enables (/BW1, /BW2, /BW3 or /BW4) are LOW.  
/BWs = H means all byte write enables (/BW1, /BW2, /BW3 or /BW4) are HIGH.

Partial Truth Table for Write Enables

[μPD44321181]

Operation	/WE	/BW1	/BW2
Read Cycle	H	×	×
Write Cycle / Byte 1 (I/O [1:8], I/OP1)	L	L	H
Write Cycle / Byte 2 (I/O [9:16], I/OP2)	L	H	L
Write Cycle / All Bytes	L	L	L
Write Abort / NOP	L	H	H

Remark × : don't care

[μPD44321361]

Operation	/WE	/BW1	/BW2	/BW3	/BW4
Read Cycle	H	×	×	×	×
Write Cycle / Byte 1 (I/O [1:8], I/OP1)	L	L	H	H	H
Write Cycle / Byte 2 (I/O [9:16], I/OP2)	L	H	L	H	H
Write Cycle / Byte 3 (I/O [17:24], I/OP3)	L	H	H	L	H
Write Cycle / Byte 4 (I/O [25:32], I/OP4)	L	H	H	H	L
Write Cycle / All Bytes	L	L	L	L	L
Write Abort / NOP	L	H	H	H	H

Remark × : don't care

ZZ (Sleep) Truth Table

ZZ	Chip Status
≤ 0.2 V	Active
Open	Active
≥ V <sub>DD</sub> - 0.2 V	Sleep

**Electrical Specifications**

**Absolute Maximum Ratings**

Parameter	Symbol	Conditions	MIN.	TYP.	MAX.	Unit
Supply voltage	V <sub>DD</sub>		-0.5		+4.0	V
Output supply voltage	V <sub>DDQ</sub>		-0.5		V <sub>DD</sub>	V
Input voltage	V <sub>IN</sub>		-0.5 <sup>Note</sup>		V <sub>DD</sub> + 0.5	V
Input / Output voltage	V <sub>IO</sub>		-0.5 <sup>Note</sup>		V <sub>DDQ</sub> + 0.5	V
Operating ambient temperature	T <sub>A</sub>		0		70	°C
Storage temperature	T <sub>stg</sub>		-55		+125	°C

**Note** -2.0 V (MIN.) (Pulse width : 2 ns)

**Caution** Exposing the device to stress above those listed in Absolute Maximum Ratings could cause permanent damage. The device is not meant to be operated under conditions outside the limits described in the operational section of this specification. Exposure to Absolute Maximum Rating conditions for extended periods may affect device reliability.

**Recommended DC Operating Conditions (V<sub>DD</sub> = 3.3 ± 0.165 V)**

(1/2)

Parameter	Symbol	Conditions	MIN.	TYP.	MAX.	Unit
Supply voltage	V <sub>DD</sub>		3.135	3.3	3.465	V
<b>2.5 V LVTTTL Interface</b>						
Output supply voltage	V <sub>DDQ</sub>		2.375	2.5	2.9	V
★ High level input voltage	V <sub>IH</sub>		2.0		V <sub>DDQ</sub> + 0.3	V
Low level input voltage	V <sub>IL</sub>		-0.3 <sup>Note</sup>		+0.7	V
<b>3.3 V LVTTTL Interface</b>						
Output supply voltage	V <sub>DDQ</sub>		3.135	3.3	3.465	V
High level input voltage	V <sub>IH</sub>		2.0		V <sub>DDQ</sub> + 0.3	V
Low level input voltage	V <sub>IL</sub>		-0.3 <sup>Note</sup>		+0.8	V

**Note** -0.8 V (MIN.) (Pulse width : 2 ns)

**Recommended DC Operating Conditions (V<sub>DD</sub> = 2.5 ± 0.125 V)**

(2/2)

Parameter	Symbol	Conditions	MIN.	TYP.	MAX.	Unit
Supply voltage	V <sub>DD</sub>		2.375	2.5	2.625	V
Output supply voltage	V <sub>DDQ</sub>		2.375	2.5	2.625	V
High level input voltage	V <sub>IH</sub>		1.7		V <sub>DDQ</sub> + 0.3	V
Low level input voltage	V <sub>IL</sub>		-0.3 <sup>Note</sup>		+0.7	V

**Note** -0.8 V (MIN.) (Pulse width : 2 ns)

**DC Characteristics (V<sub>DD</sub> = 3.3 ± 0.165 V or 2.5 ± 0.125 V)**

Parameter	Symbol	Test condition	MIN.	TYP.	MAX.	Unit
Input leakage current	I <sub>LI</sub>	V <sub>IN</sub> (except ZZ, MODE) = 0 V to V <sub>DD</sub>	-2		+2	μA
I/O leakage current	I <sub>LO</sub>	V <sub>I/O</sub> = 0 V to V <sub>DDQ</sub> , Outputs are disabled.	-2		+2	μA
Operating supply current	I <sub>DD</sub>	Device selected, Cycle = MAX. V <sub>IN</sub> ≤ V <sub>IL</sub> or V <sub>IN</sub> ≥ V <sub>IH</sub> , I <sub>I/O</sub> = 0 mA			290	mA
Standby supply current	I <sub>SB</sub>	Device deselected, Cycle = 0 MHz, V <sub>IN</sub> ≤ V <sub>IL</sub> or V <sub>IN</sub> ≥ V <sub>IH</sub> , All inputs are static.			70	mA
	I <sub>SB1</sub>	Device deselected, Cycle = 0 MHz, V <sub>IN</sub> ≤ 0.2 V or V <sub>IN</sub> ≥ V <sub>DD</sub> - 0.2 V, V <sub>I/O</sub> ≤ 0.2 V, All inputs are static.			60	
	I <sub>SB2</sub>	Device deselected, Cycle = MAX. V <sub>IN</sub> ≤ V <sub>IL</sub> or V <sub>IN</sub> ≥ V <sub>IH</sub>			110	
Power down supply current	I <sub>SBZZ</sub>	ZZ ≥ V <sub>DD</sub> - 0.2 V, V <sub>I/O</sub> ≤ V <sub>DDQ</sub> + 0.2 V			60	mA
<b>2.5 V LVTTTL Interface</b>						
High level output voltage	V <sub>OH</sub>	I <sub>OH</sub> = -2.0 mA	1.7			V
		I <sub>OH</sub> = -1.0 mA	2.1			
Low level output voltage	V <sub>OL</sub>	I <sub>OL</sub> = +2.0 mA			0.7	V
		I <sub>OL</sub> = +1.0 mA			0.4	
<b>3.3 V LVTTTL Interface</b>						
High level output voltage	V <sub>OH</sub>	I <sub>OH</sub> = -4.0 mA	2.4			V
Low level output voltage	V <sub>OL</sub>	I <sub>OL</sub> = +8.0 mA			0.4	V

**Capacitance (T<sub>A</sub> = 25 °C, f = 1MHz)**

Parameter	Symbol	Test condition	MIN.	TYP.	MAX.	Unit
Input capacitance	C <sub>IN</sub>	V <sub>IN</sub> = 0 V			6.0	pF
Input / Output capacitance	C <sub>I/O</sub>	V <sub>I/O</sub> = 0 V			8.0	pF
Clock input capacitance	C <sub>clk</sub>	V <sub>clk</sub> = 0 V			6.0	pF

**Remark** These parameters are periodically sampled and not 100% tested.

AC Characteristics ( $V_{DD} = 3.3 \pm 0.165 \text{ V}$  or  $2.5 \pm 0.125 \text{ V}$ )

AC Test Conditions

2.5 V LVTTTL Interface

Input waveform (Rise / Fall time  $\leq 2.4 \text{ ns}$ )

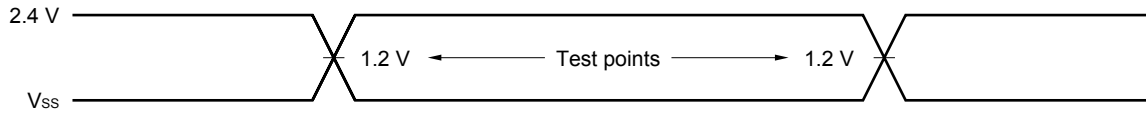

Output waveform

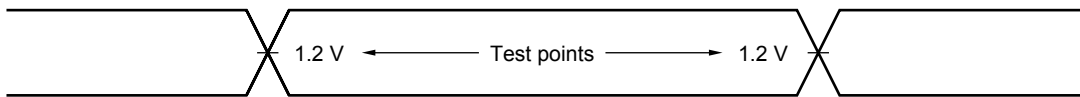

3.3 V LVTTTL Interface

Input waveform (Rise / Fall time  $\leq 3.0 \text{ ns}$ )

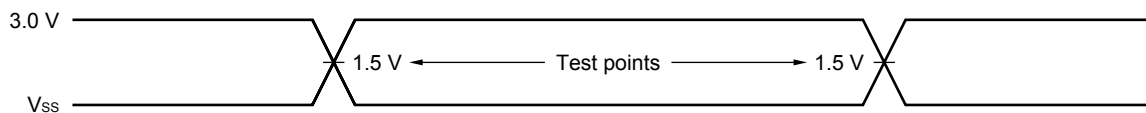

Output waveform

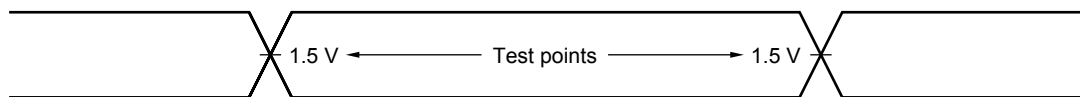

Output load condition

$C_L$ : 30 pF

5 pF (TKHQX1, TKHQX2, TGLQX, TGHQZ, TKHQZ)

Figure External load at test

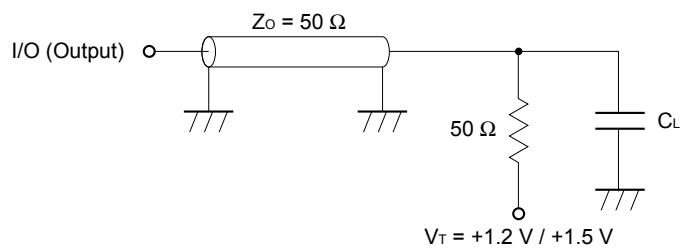

**Remark**  $C_L$  includes capacitances of the probe and jig, and stray capacitances.

Read and Write Cycle

Parameter	Symbol		-A75 (117 MHz)		Unit	Notes
	Standard	Alias	MIN.	MAX.		
Cycle time	TKHKH	TCYC	8.6	–	ns	
Clock access time	TKHQV	TCD	–	7.5	ns	
Output enable access time	TGLQV	TOE	–	3.5	ns	
Clock high to output active	TKHQX1	TDC1	2.5	–	ns	1, 2
Clock high to output change	TKHQX2	TDC2	2.5	–	ns	
Output enable to output active	TGLQX	TOLZ	0	–	ns	1
Output disable to output High-Z	TGHQZ	TOHZ	0	3.5	ns	1
Clock high to output High-Z	TKHQZ	TCZ	2.5	5	ns	1, 2
Clock high pulse width	TKHKL	TCH	2.5	–	ns	
Clock low pulse width	TKLKH	TCL	2.5	–	ns	
Setup times	Address	TAVKH	TAS	1.5	–	ns
	Address advance	TADVVKH	TADVS			
	Clock enable	TEVKH	TCES			
	Chip enable	TCVKH	TCSS			
	Data in	TDVKH	TDS			
	Write enable	TWVKH	TWS			
Hold times	Address	TKHAX	TAH	0.5 (1.0)	– (–)	ns
	Address advance	TKHADVX	TADVH			
	Clock enable	TKHEX	TCEH			
	Chip enable	TKHCX	TCSH			
	Data in	TKHDX	TDH			
	Write enable	TKHWX	TWH			
Power down entry time	TZZE	TZZE	–	8.6	ns	
Power down recovery time	TZZR	TZZR	–	8.6	ns	

**Notes** 1. Transition is measured ±200 mV from steady state.

2. To avoid bus contention, the output buffers are designed such that TKHQZ (device turn-off) is faster than TKHQX1 (device turn-on) at a given temperature and voltage. The specs as shown do not imply bus contention because TKHQX1 is a min. parameter that is worse case at totally different conditions ( $T_A$  min.,  $V_{DD}$  max.) than TKHQZ, which is a max. parameter (worse case at  $T_A$  max.,  $V_{DD}$  min.).

3. These values apply when  $V_{DD} = 3.3 \text{ V} \pm 0.165 \text{ V}$  with a 3.3 V LVTTTL interface, or when  $V_{DD} = 2.5 \text{ V} \pm 0.125 \text{ V}$  with a 2.5 V LVTTTL interface.

Values in parentheses apply when  $V_{DD} = 3.3 \text{ V} \pm 0.165 \text{ V}$  with a 2.5 V LVTTTL interface.

READ / WRITE CYCLE

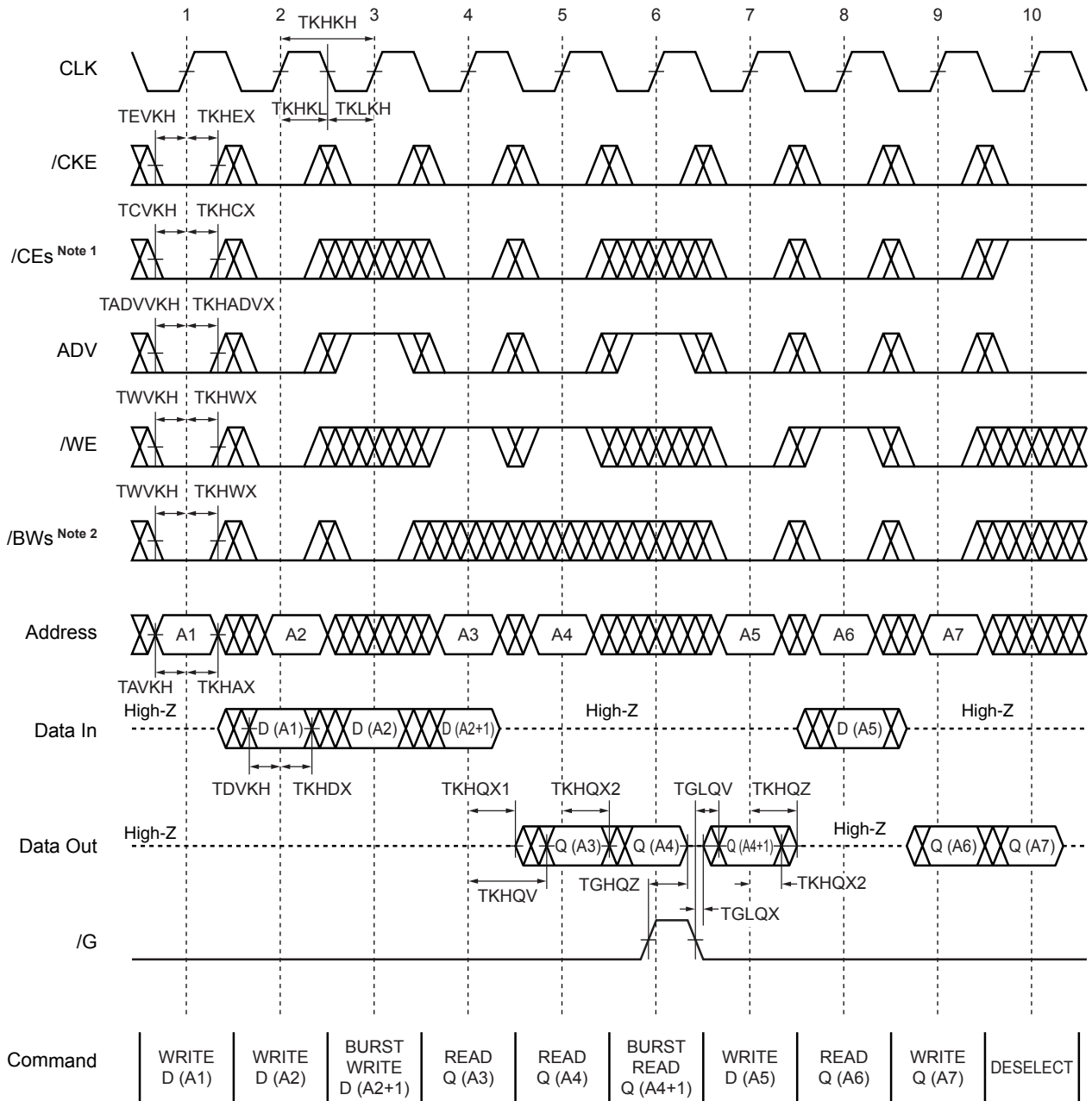

- Notes**
1. /CEs refers to /CE, CE2 and /CE2. When /CEs is LOW, /CE and /CE2 are LOW and CE2 is HIGH. When /CEs is HIGH, /CE and /CE2 are HIGH and CE2 is LOW.
  2. /BWs refers to /BW1, /BW2, /BW3 and /BW4. When /BWs is LOW, any one or more byte write enables (/BW1, /BW2, /BW3 or /BW4) are LOW.



NOP, STALL AND DESELECT CYCLE

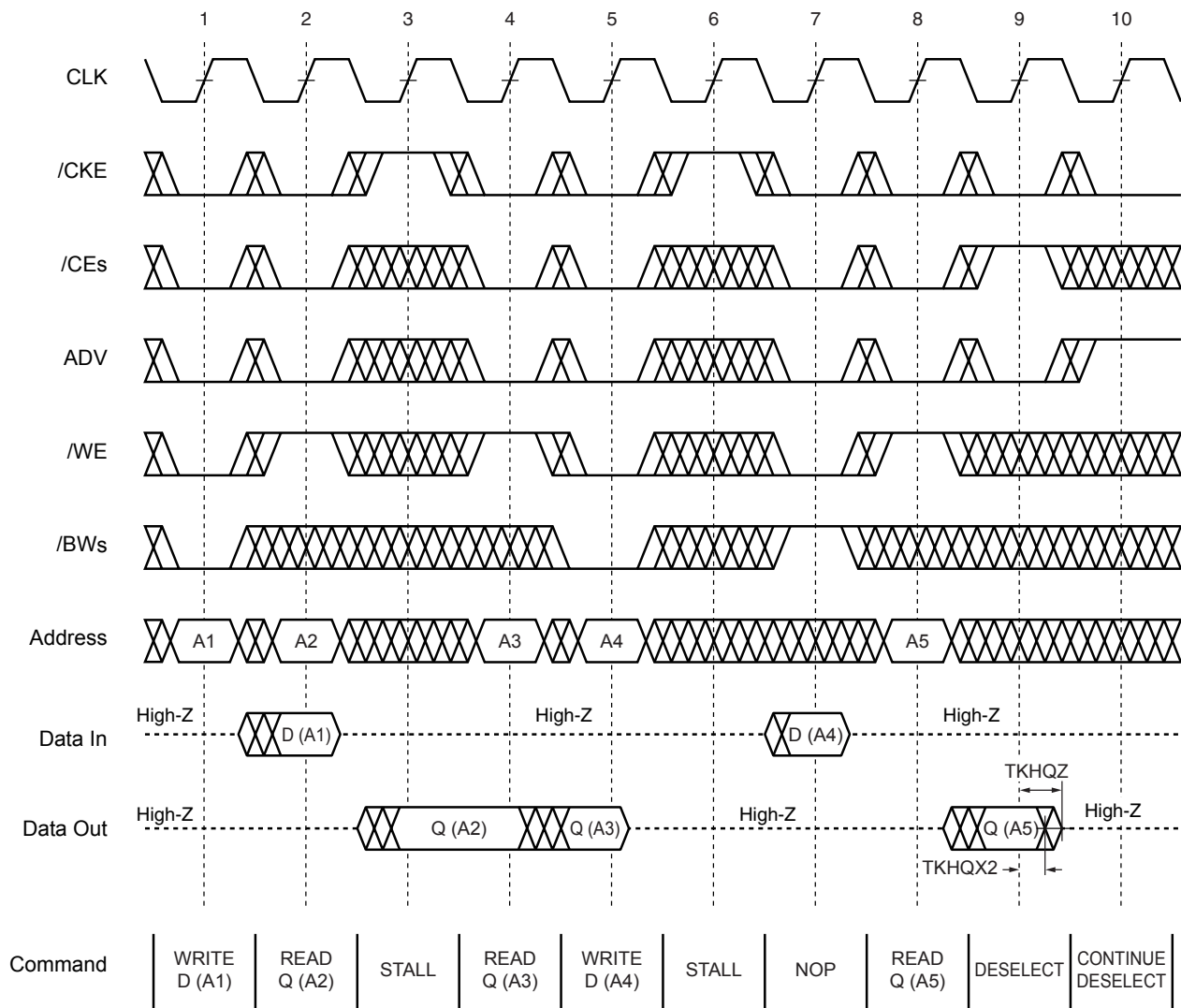

POWER DOWN (ZZ) CYCLE

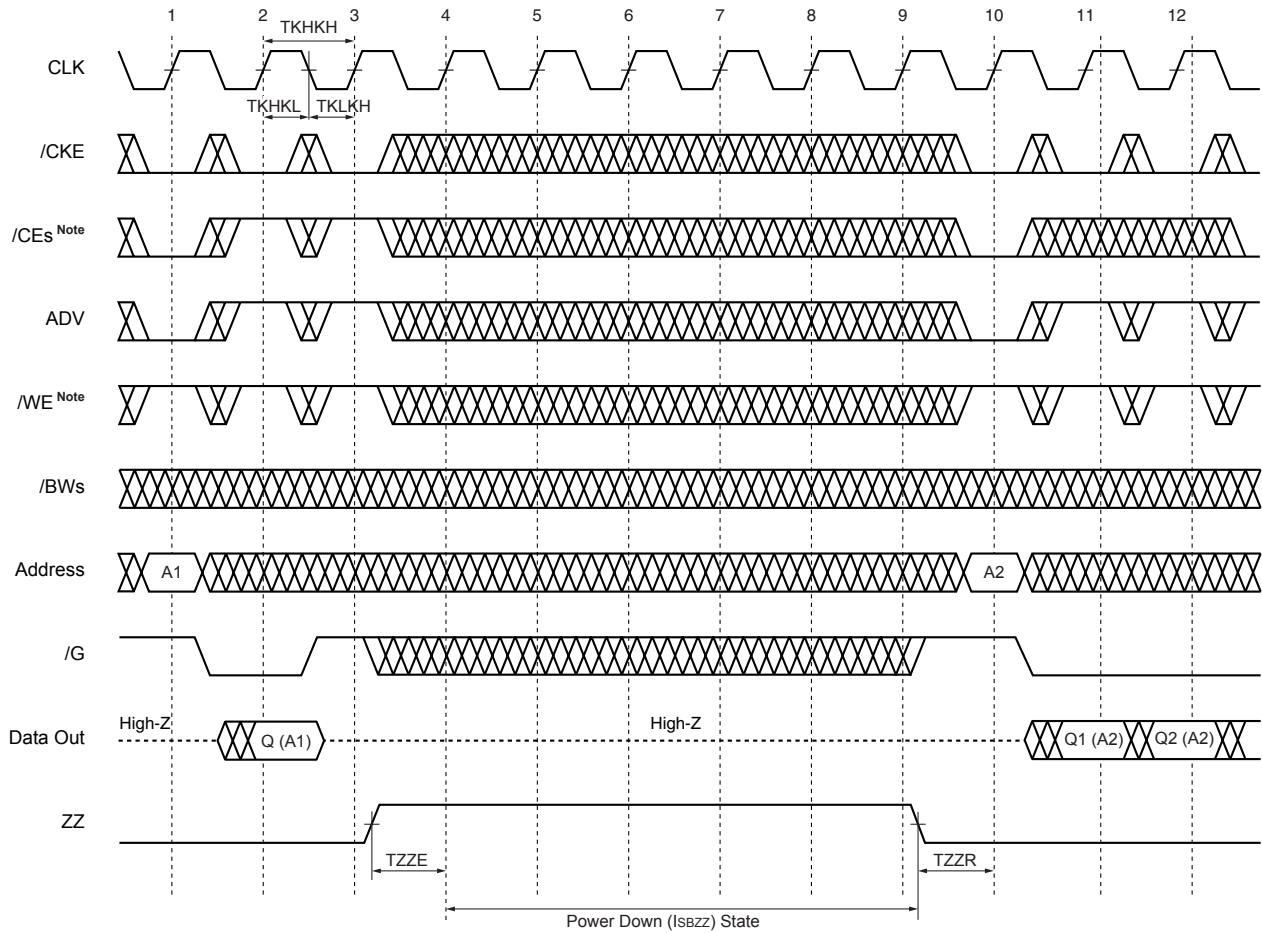

**Note** /WE or /CEs must be held HIGH at CLK rising edge (clock edge No.3 in this figure) prior to power down state entry.

Package Drawing

100-PIN PLASTIC LQFP (14x20)

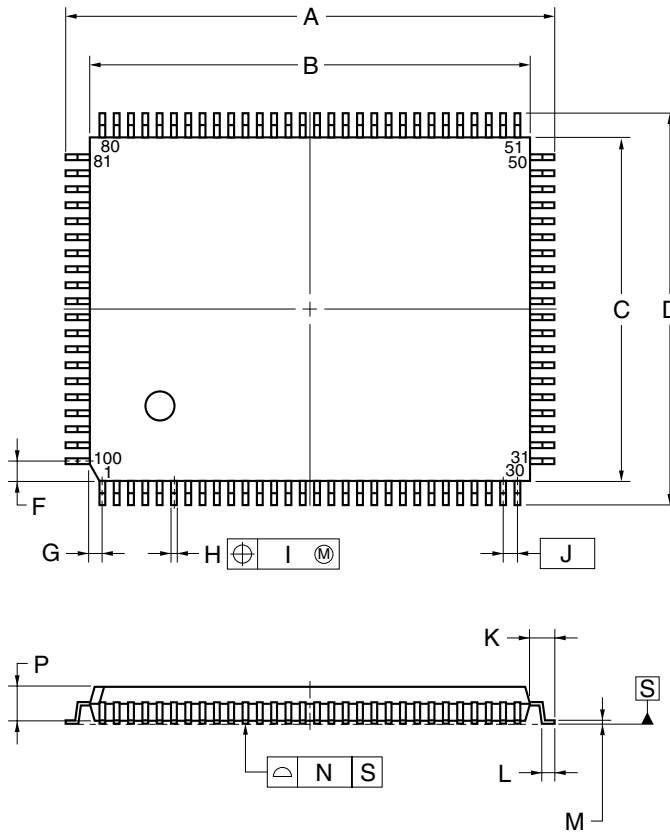

detail of lead end

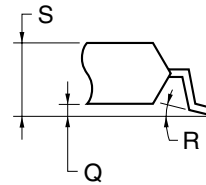

NOTE

Each lead centerline is located within 0.13 mm of its true position (T.P.) at maximum material condition.

ITEM	MILLIMETERS
A	22.0±0.2
B	20.0±0.2
C	14.0±0.2
D	16.0±0.2
F	0.825
G	0.575
H	0.32 <sup>+0.08</sup> <sub>-0.07</sub>
I	0.13
J	0.65 (T.P.)
K	1.0±0.2
L	0.5±0.2
M	0.17 <sup>+0.06</sup> <sub>-0.05</sub>
N	0.10
P	1.4
Q	0.125±0.075
R	3° <sup>+7°</sup> <sub>-3°</sub>
S	1.7 MAX.
<b>S100GF-65-8ET-1</b>	

**Recommended Soldering Condition**

Please consult with our sales offices for soldering conditions of the  $\mu$ PD44321181 and  $\mu$ PD44321361.

**Types of Surface Mount Devices**

$\mu$ PD44321181GF : 100-pin PLASTIC LQFP (14 x 20)

$\mu$ PD44321361GF : 100-pin PLASTIC LQFP (14 x 20)

**Revision History**

Edition/ Date	Page		Type of revision	Location	Description (Previous edition → This edition)
	This edition	Previous edition			
5th edition/ Apr. 2005	Throughout	Throughout	Modification	–	Preliminary Data Sheet → Data Sheet
			Deletion	–	-A85, -A75Y, -A85Y
	p.12	p.12	Modification	Recommended DC Operating Conditions (1/2)	V <sub>IH</sub> (MIN.): 1.7 V → 2.0 V

[MEMO]

## NOTES FOR CMOS DEVICES

**① VOLTAGE APPLICATION WAVEFORM AT INPUT PIN**

Waveform distortion due to input noise or a reflected wave may cause malfunction. If the input of the CMOS device stays in the area between  $V_{IL}$  (MAX) and  $V_{IH}$  (MIN) due to noise, etc., the device may malfunction. Take care to prevent chattering noise from entering the device when the input level is fixed, and also in the transition period when the input level passes through the area between  $V_{IL}$  (MAX) and  $V_{IH}$  (MIN).

**② HANDLING OF UNUSED INPUT PINS**

Unconnected CMOS device inputs can be cause of malfunction. If an input pin is unconnected, it is possible that an internal input level may be generated due to noise, etc., causing malfunction. CMOS devices behave differently than Bipolar or NMOS devices. Input levels of CMOS devices must be fixed high or low by using pull-up or pull-down circuitry. Each unused pin should be connected to  $V_{DD}$  or GND via a resistor if there is a possibility that it will be an output pin. All handling related to unused pins must be judged separately for each device and according to related specifications governing the device.

**③ PRECAUTION AGAINST ESD**

A strong electric field, when exposed to a MOS device, can cause destruction of the gate oxide and ultimately degrade the device operation. Steps must be taken to stop generation of static electricity as much as possible, and quickly dissipate it when it has occurred. Environmental control must be adequate. When it is dry, a humidifier should be used. It is recommended to avoid using insulators that easily build up static electricity. Semiconductor devices must be stored and transported in an anti-static container, static shielding bag or conductive material. All test and measurement tools including work benches and floors should be grounded. The operator should be grounded using a wrist strap. Semiconductor devices must not be touched with bare hands. Similar precautions need to be taken for PW boards with mounted semiconductor devices.

**④ STATUS BEFORE INITIALIZATION**

Power-on does not necessarily define the initial status of a MOS device. Immediately after the power source is turned ON, devices with reset functions have not yet been initialized. Hence, power-on does not guarantee output pin levels, I/O settings or contents of registers. A device is not initialized until the reset signal is received. A reset operation must be executed immediately after power-on for devices with reset functions.

**⑤ POWER ON/OFF SEQUENCE**

In the case of a device that uses different power supplies for the internal operation and external interface, as a rule, switch on the external power supply after switching on the internal power supply. When switching the power supply off, as a rule, switch off the external power supply and then the internal power supply. Use of the reverse power on/off sequences may result in the application of an overvoltage to the internal elements of the device, causing malfunction and degradation of internal elements due to the passage of an abnormal current.

The correct power on/off sequence must be judged separately for each device and according to related specifications governing the device.

**⑥ INPUT OF SIGNAL DURING POWER OFF STATE**

Do not input signals or an I/O pull-up power supply while the device is not powered. The current injection that results from input of such a signal or I/O pull-up power supply may cause malfunction and the abnormal current that passes in the device at this time may cause degradation of internal elements. Input of signals during the power off state must be judged separately for each device and according to related specifications governing the device.

ZEROSB is a trademark of NEC Electronics Corporation.

• **The information in this document is current as of April, 2005. The information is subject to change without notice. For actual design-in, refer to the latest publications of NEC Electronics data sheets or data books, etc., for the most up-to-date specifications of NEC Electronics products. Not all products and/or types are available in every country. Please check with an NEC Electronics sales representative for availability and additional information.**

• No part of this document may be copied or reproduced in any form or by any means without the prior written consent of NEC Electronics. NEC Electronics assumes no responsibility for any errors that may appear in this document.

• NEC Electronics does not assume any liability for infringement of patents, copyrights or other intellectual property rights of third parties by or arising from the use of NEC Electronics products listed in this document or any other liability arising from the use of such products. No license, express, implied or otherwise, is granted under any patents, copyrights or other intellectual property rights of NEC Electronics or others.

• Descriptions of circuits, software and other related information in this document are provided for illustrative purposes in semiconductor product operation and application examples. The incorporation of these circuits, software and information in the design of a customer's equipment shall be done under the full responsibility of the customer. NEC Electronics assumes no responsibility for any losses incurred by customers or third parties arising from the use of these circuits, software and information.

• While NEC Electronics endeavors to enhance the quality, reliability and safety of NEC Electronics products, customers agree and acknowledge that the possibility of defects thereof cannot be eliminated entirely. To minimize risks of damage to property or injury (including death) to persons arising from defects in NEC Electronics products, customers must incorporate sufficient safety measures in their design, such as redundancy, fire-containment and anti-failure features.

• NEC Electronics products are classified into the following three quality grades: "Standard", "Special" and "Specific".

The "Specific" quality grade applies only to NEC Electronics products developed based on a customer-designated "quality assurance program" for a specific application. The recommended applications of an NEC Electronics product depend on its quality grade, as indicated below. Customers must check the quality grade of each NEC Electronics product before using it in a particular application.

"Standard": Computers, office equipment, communications equipment, test and measurement equipment, audio and visual equipment, home electronic appliances, machine tools, personal electronic equipment and industrial robots.

"Special": Transportation equipment (automobiles, trains, ships, etc.), traffic control systems, anti-disaster systems, anti-crime systems, safety equipment and medical equipment (not specifically designed for life support).

"Specific": Aircraft, aerospace equipment, submersible repeaters, nuclear reactor control systems, life support systems and medical equipment for life support, etc.

The quality grade of NEC Electronics products is "Standard" unless otherwise expressly specified in NEC Electronics data sheets or data books, etc. If customers wish to use NEC Electronics products in applications not intended by NEC Electronics, they must contact an NEC Electronics sales representative in advance to determine NEC Electronics' willingness to support a given application.

(Note)

(1) "NEC Electronics" as used in this statement means NEC Electronics Corporation and also includes its majority-owned subsidiaries.

(2) "NEC Electronics products" means any product developed or manufactured by or for NEC Electronics (as defined above).