

TOSHIBA LED Lamp InGaAlP Red Light Emission

TLRH262

Panel Circuit Indicator

- 3.1 mm diameter (T1)
- InGaAlP red LED
- All plastic mold type.
- Colorless clear lens
- Low drive current, high intensity red light emission
Recommended forward current: $I_F = 1\sim 20$ mA (DC)
- All plastic molded lens, provides an excellent on-off contrast ratio.
- Fast response time, capable of pulse operation.
- High power luminous intensity
- Applications: Suitable for backlighting.

Maximum Ratings (Ta = 25°C)

Characteristic	Symbol	Rating	Unit
Forward current (DC)	I_F	50	mA
Reverse voltage	V_R	4	V
Power dissipation	P_D	125	mW
Operating temperature range	T_{opr}	-30~85	°C
Storage temperature range	T_{stg}	-40~120	°C

Electrical And Optical Characteristics (Ta = 25°C)

Characteristic		Symbol	Test Condition	Min	Typ.	Max	Unit
Forward voltage		V_F	$I_F = 20$ mA	—	1.9	2.5	V
Reverse current		I_R	$V_R = 4$ V	—	—	50	μA
Luminous intensity	TLRH262	I_V	$I_F = 20$ mA (Note)	85	220	—	mcd
	TLRH262 (NP)			85	—	414	
Peak emission wavelength		λ_P	$I_F = 20$ mA	—	644	—	nm
Spectral line half width		$\Delta\lambda$	$I_F = 20$ mA	—	18	—	nm
Dominant wavelength		λ_d	$I_F = 20$ mA	—	630	—	nm

(Note): Lamps are classified into the following ranks according to their luminous intensity.
 Measurement tolerance for each limit is ±15%.
 N: 100–200 mcd, P: 180–360 mcd, Q: 320–640 mcd.

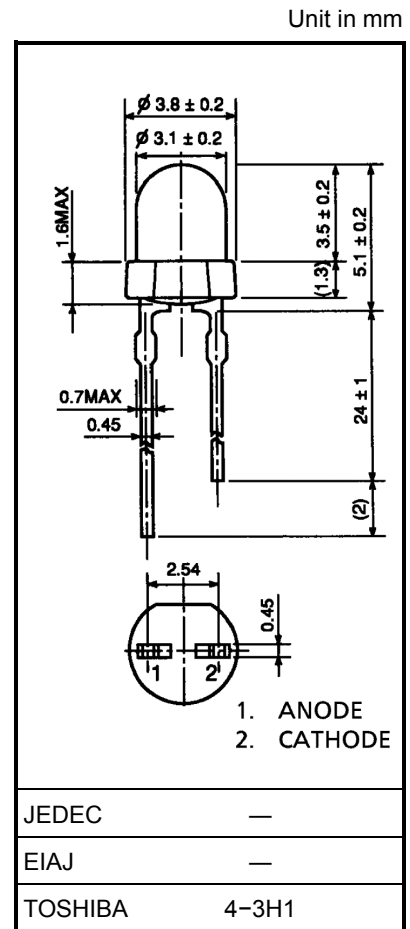

Weight: 0.14 g

Precaution

Please be careful of the followings

- Soldering temperature: 260°C max Soldering time : 3 s max
(soldering portion of lead: Up to 2 mm from the body of the device)
- If the lead is formed, the lead should be formed up to 5 mm from the body of the device without forming stress to the resin. Soldering should be performed after lead forming.
- This visible LED lamp also emits some IR light. If a photodetector is located near the LED lamp, please ensure that it will not be affected by this IR light.

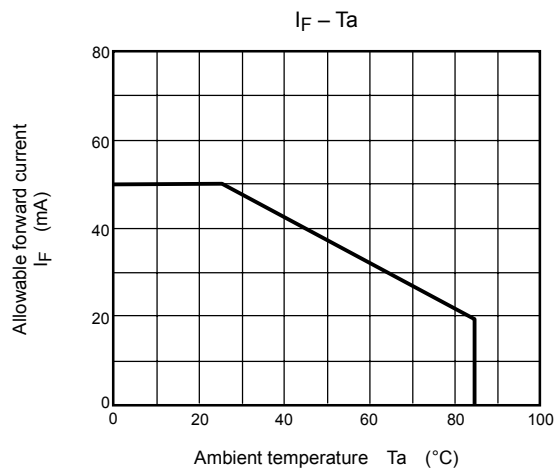
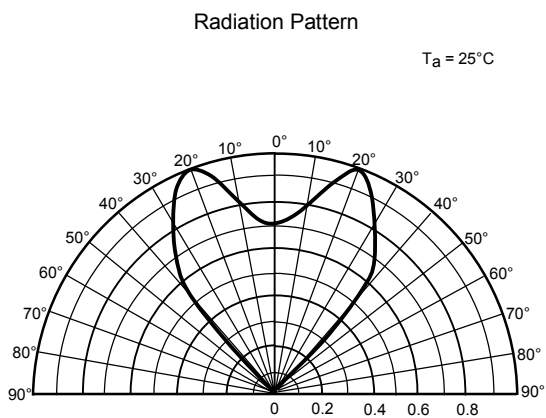
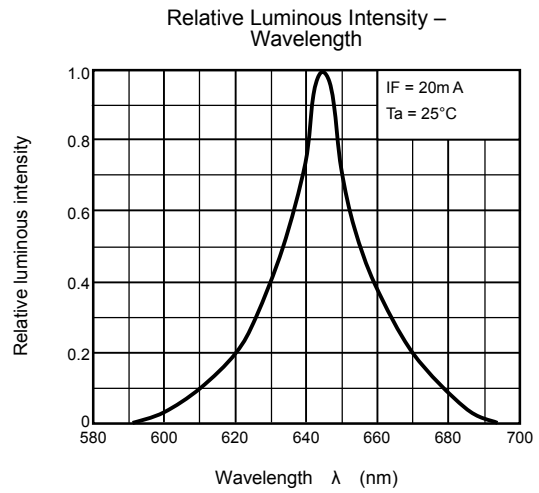
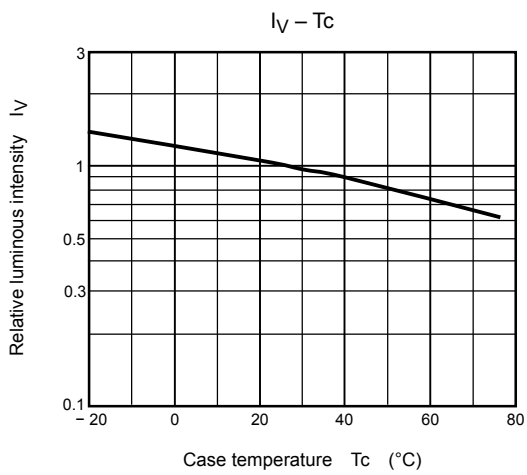
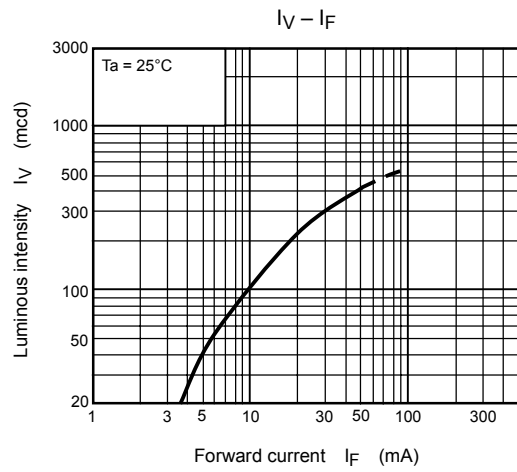
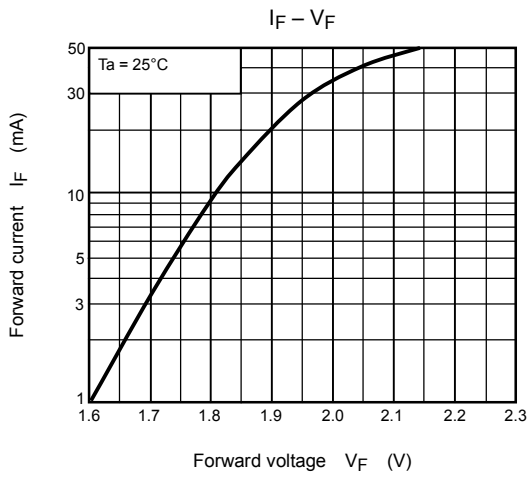

RESTRICTIONS ON PRODUCT USE

000707EAC

- TOSHIBA is continually working to improve the quality and reliability of its products. Nevertheless, semiconductor devices in general can malfunction or fail due to their inherent electrical sensitivity and vulnerability to physical stress. It is the responsibility of the buyer, when utilizing TOSHIBA products, to comply with the standards of safety in making a safe design for the entire system, and to avoid situations in which a malfunction or failure of such TOSHIBA products could cause loss of human life, bodily injury or damage to property.
In developing your designs, please ensure that TOSHIBA products are used within specified operating ranges as set forth in the most recent TOSHIBA products specifications. Also, please keep in mind the precautions and conditions set forth in the "Handling Guide for Semiconductor Devices," or "TOSHIBA Semiconductor Reliability Handbook" etc..
- The TOSHIBA products listed in this document are intended for usage in general electronics applications (computer, personal equipment, office equipment, measuring equipment, industrial robotics, domestic appliances, etc.). These TOSHIBA products are neither intended nor warranted for usage in equipment that requires extraordinarily high quality and/or reliability or a malfunction or failure of which may cause loss of human life or bodily injury ("Unintended Usage"). Unintended Usage include atomic energy control instruments, airplane or spaceship instruments, transportation instruments, traffic signal instruments, combustion control instruments, medical instruments, all types of safety devices, etc.. Unintended Usage of TOSHIBA products listed in this document shall be made at the customer's own risk.
- Gallium arsenide (GaAs) is a substance used in the products described in this document. GaAs dust and fumes are toxic. Do not break, cut or pulverize the product, or use chemicals to dissolve them. When disposing of the products, follow the appropriate regulations. Do not dispose of the products with other industrial waste or with domestic garbage.
- The information contained herein is presented only as a guide for the applications of our products. No responsibility is assumed by TOSHIBA CORPORATION for any infringements of intellectual property or other rights of the third parties which may result from its use. No license is granted by implication or otherwise under any intellectual property or other rights of TOSHIBA CORPORATION or others.
- The information contained herein is subject to change without notice.