

Description

- High speed switching application.
- Analog switch applications.

Features

- -2.5V Gate drive.
- Low threshold voltage : $V_{th} = -0.5 \sim -1.5V$.
- High speed.

Ordering Information

Type NO.	Marking	Package Code
STJ828SF	J28	SOT-23F

Outline Dimensions

unit : mm

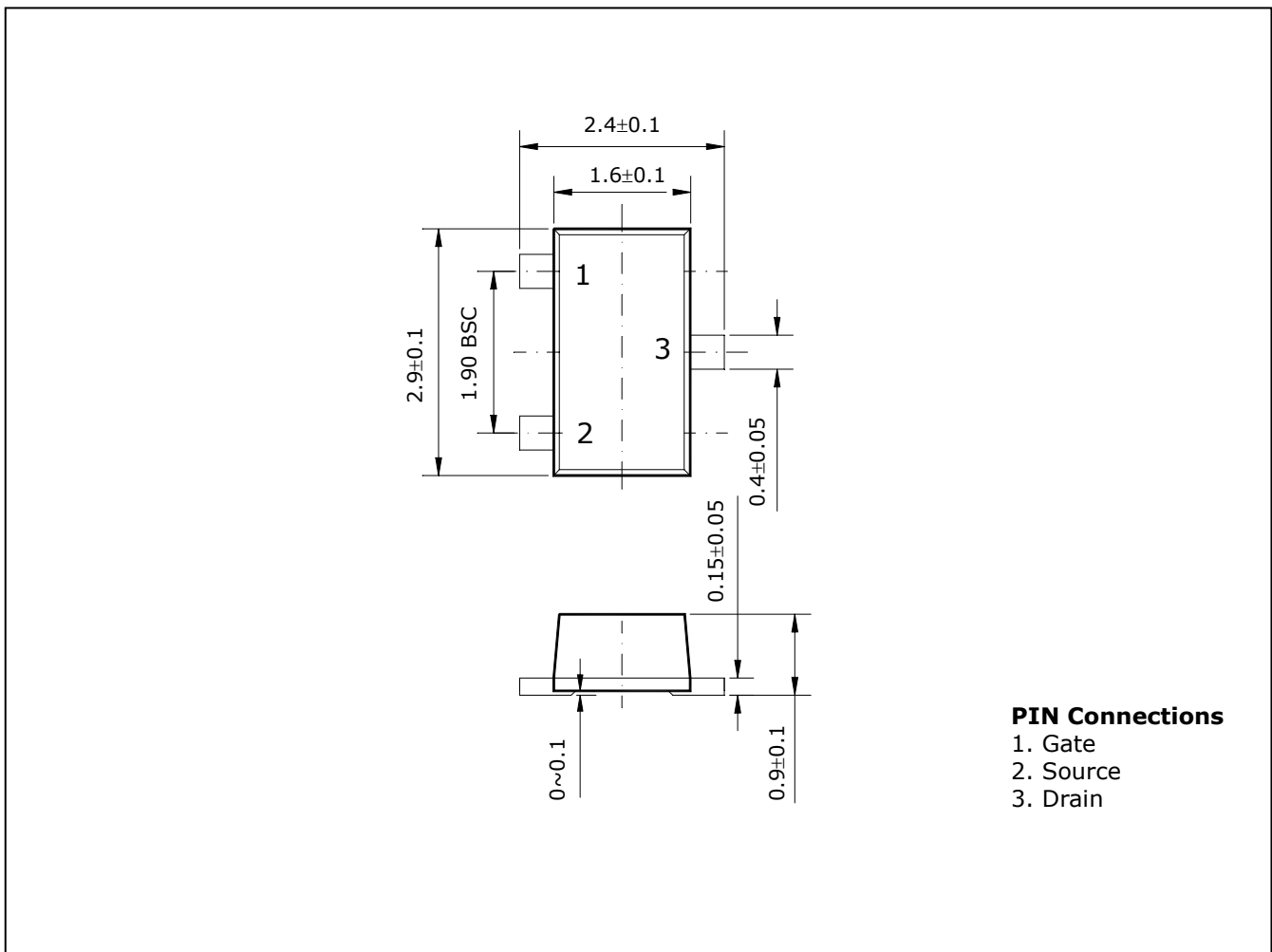

Absolute maximum ratings

(Ta=25°C)

Characteristic	Symbol	Ratings	Unit
Drain-Source voltage	V_{DS}	-20	V
Gate-Source voltage	V_{GSS}	± 7	V
DC Drain current	I_D	-50	mA
Drain Power dissipation	P_D	200	mW
Channel temperature	T_{ch}	150	°C
Storage temperature range	T_{stg}	-55~150	°C

Electrical Characteristics

(Ta=25°C)

Characteristic	Symbol	Test Condition	Min.	Typ.	Max.	Unit
Drain-Source breakdown voltage	BV_{DSS}	$I_D = -100\mu A, V_{GS} = 0$	-20	-	-	V
Gate-Threshold voltage	V_{th}	$I_D = -0.1mA, V_{DS} = -3V$	-0.5	-	-1.5	V
Drain cut-off current	I_{DSS}	$V_{DS} = -20V, V_{GS} = 0$	-	-	-1	μA
Gate leakage current	I_{GSS}	$V_{GS} = \pm 7V, V_{DS} = 0$	-	-	± 1	μA
Drain-Source on-resistance	$R_{DS(ON)}$	$V_{GS} = -2.5V, I_D = -10mA$	-	-	40	Ω
Forward transfer admittance	$ Y_{fs} $	$V_{DS} = -3V, I_D = -10mA$	15	-	-	mS
Input capacitance	C_{iss}	$V_{DS} = -3V, V_{GS} = 0, f = 1MHz$	-	10.4	-	pF
Output capacitance	C_{oss}	$V_{DS} = -3V, V_{GS} = 0, f = 1MHz$	-	8.4	-	pF
Reverse Transfer capacitance	C_{rss}	$V_{DS} = -3V, V_{GS} = 0, f = 1MHz$	-	2.8	-	pF
Turn-on time	t_{ON}	$V_{DD} = -3V, I_D = -10mA$ $V_{GEN} = 0 \sim -2.5V$	-	0.15	-	μs
Turn-off time	t_{OFF}	$V_{DD} = -3V, I_D = -10mA$ $V_{GEN} = 0 \sim -2.5V$	-	0.13	-	μs

*. Switching Time Test Circuit

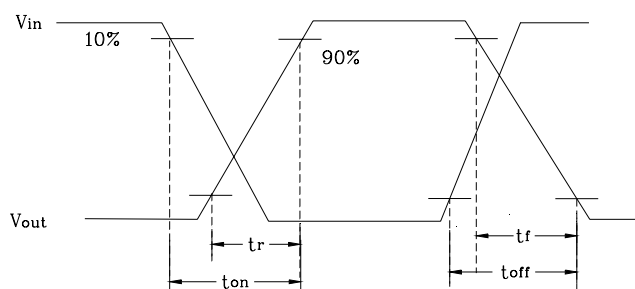
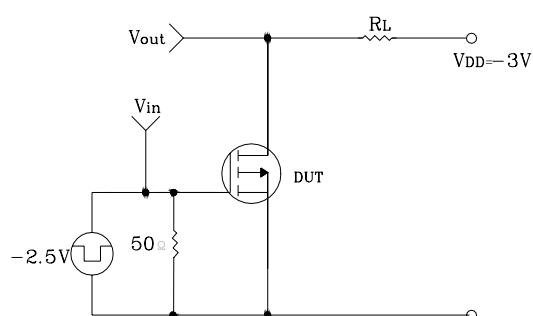

Electrical Characteristic Curves

Fig1 I_D - V_{DS}

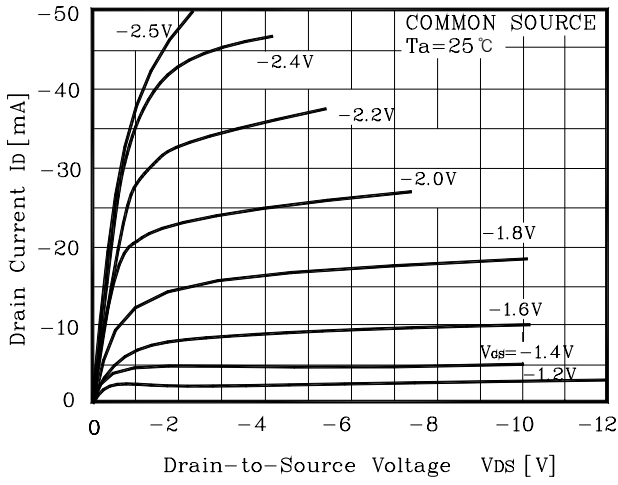

Fig2 I_D - V_{DS}

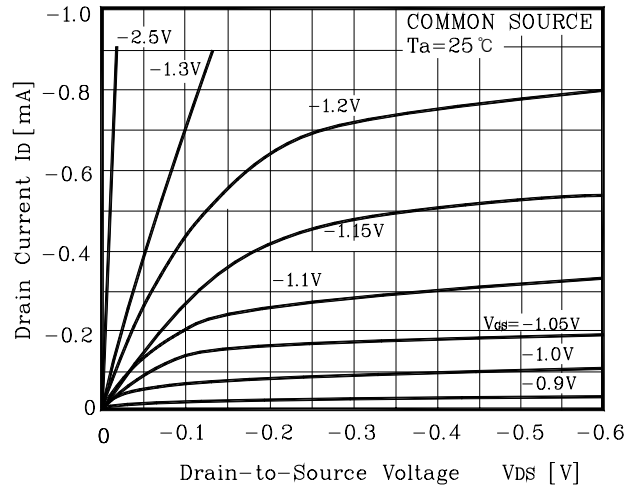

Fig3 I_{DR} - V_{DS}

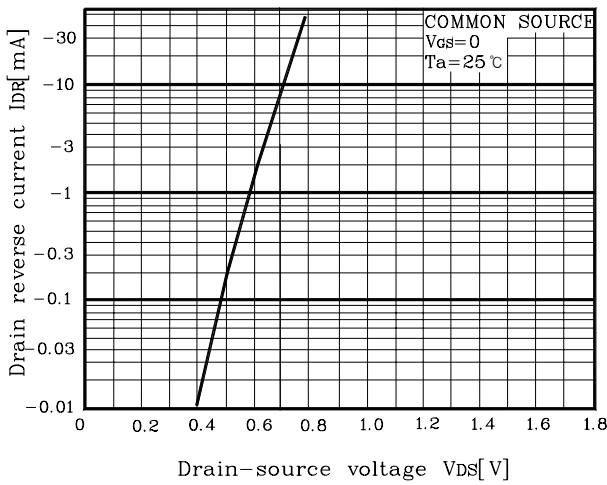

Fig4 I_D - V_{GS}

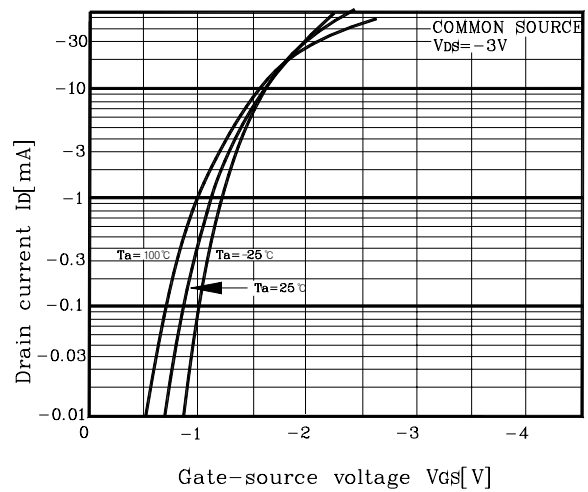

Fig5 $|Y_{fs}|$ - I_D

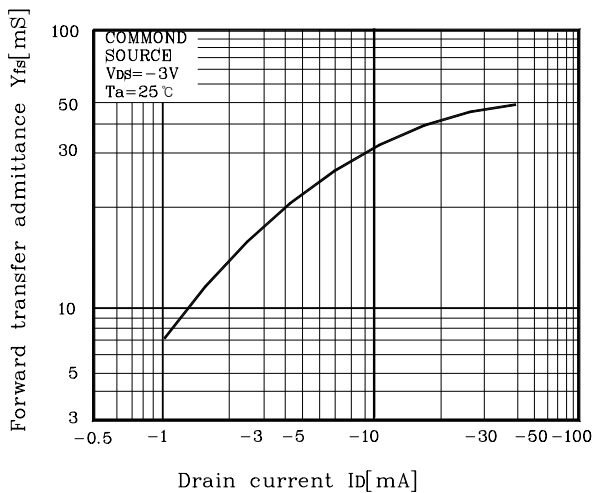

Fig6 C - V_{DS}

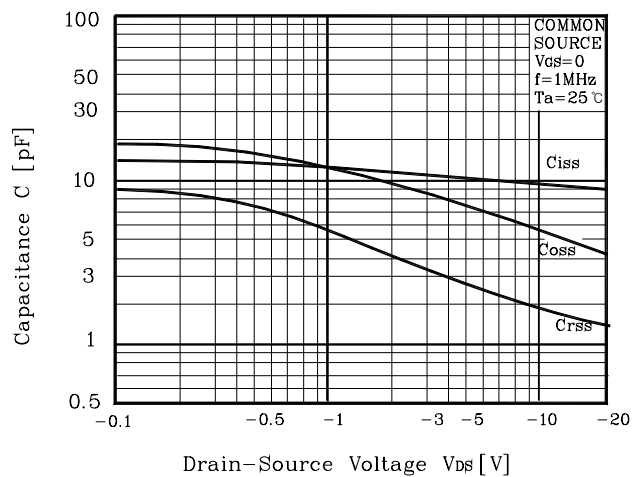

Fig7 VDS(on) - Id

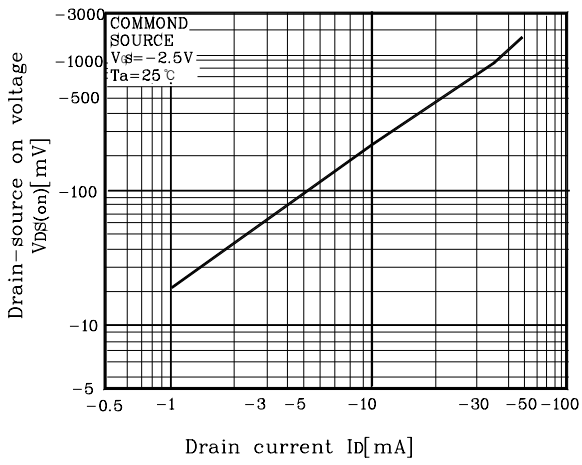

Fig8 t - Id

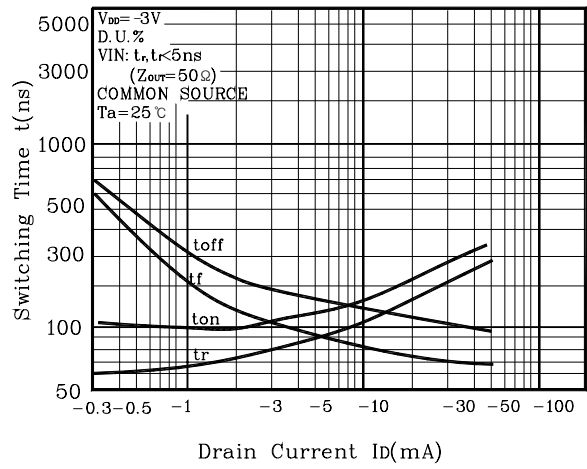

Fig9 Pd - Ta

