

# SD7005 Fan Controller

**Features**

- Use 32768 Hz crystal time base.
- Three wind modes : Constant wind, Rhythmical wind, Sleep wind.
- Three wind grades : Soft wind, Medium wind, Strong wind.
- Six types of timing function selection by bonding options.
- Key-in protection function.
- Wide power supply range : 3.0V ~5.5V.
- Low power consumption.
- Summable/Non-summable timer function selection.

**General Description**

SD7005 is a CMOS LSI designed for use in fan controllers. In the rhythmical wind mode, the wind speed is programmable. For example, it can be programmed to be soft--medium--strong--soft etc. In sleep wind mode, the wind speed is automatically decreasing.

Summable/Non-summable timer function provides more flexible timing choice. Two types of timer steps (0.5 → 1 → 2 → 4 & 1 → 2 → 4 → 8) can also be selected by users.

Type	Option Pin	Summable/Non-summable	Timer	Maximum Time
SD7005-C	Floating/VDD	Non-summable	1→2→4→8 (hours)	8 hour
	GND	Summable	1→2→4→8 (hours)	15 hour
SD7005-D	Floating/VDD	Non-summable	0.5→1→2→4 (hours)	4 hour
	GND	Summable	0.5→1→2→4 (hours)	7.5 hours

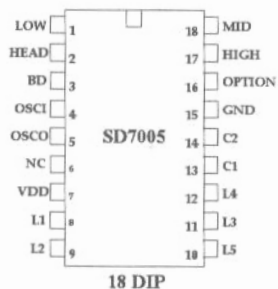
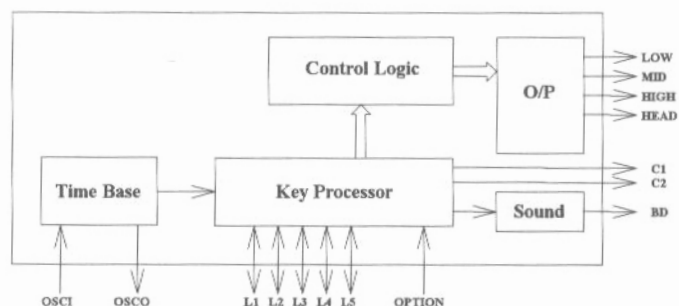
**Pin Configuration**

**SD7005 Block Diagram**

**Pin Description**

Pin No.	Symbol	Description
1	LOW	Soft wind output (driving TRIAC).
2	HEAD	Swing head control output (driving TRIAC).
3	BD	Buzzer output.
4	OSCI	32768 Hz crystal oscillator input.
5	OSCO	32768 Hz crystal oscillator output.
6	NC	For testing.
7	VDD	Positive power supply.
8	L1	Wind speed selector and LED output.
9	L2	Enable swing head and LED output.
10	L5	Chip disable and LED output.
11	L3	Timer setting and LED output.
12	L4	Wind mode selector and LED output.
13	C1	LED pattern common pin 1.
14	C2	LED pattern common pin 2.
15	GND	Negative power supply.
16	OPTION	Summerable/Non-summerable mode selection. Floating/VDD : Non-summerable. GND : Summerable.
17	HIGH	Strong wind output (driving TRIAC).
18	MID	Medium wind output (driving TRIAC).

**Absolute Maximum Ratings**

RATING	VALUE
DC Supply Voltage	< 5.5V
Input/Output Voltage	GND-0.5V to VDD+0.5V
Operating Temperature	-10° C to 60° C
Storage Temperature	-25° C to 125° C

**Notice:** Stress greater than those listed under **Absolute Maximum Ratings** may cause permanent damage to the device. This is a stress rating only and functional operation of the device at these or any other conditions above those indicated in the operational sections of this specification is not implied, Exposure to absolute maximum rating conditions for extended period may affect reliability.

**Electrical Characteristics**

( VDD = 4.5V, GND = 0V, Ta = 25°C, unless otherwise specified)

Parameter	Symbol	Min.	Type.	Max.	Condition
Operating Voltage	Vdd	3.0V	4.5V	5.0V	
Current On TRIAC Driver Pin	I <sub>TRIAC</sub>	---	10mA	---	Vout=3V
Current On LED Driver Pin	I <sub>driving</sub>	---	6mA	---	Vout=3V
Current On C1, C2 Pin	I <sub>sinking</sub>	---	33mA	---	Vout=1.5V
Current On BD Pin	I <sub>driving</sub> & I <sub>sinking</sub>	---	2mA	---	
Crystal Oscillator Frequency	F <sub>req.</sub>	---	32768 Hz	---	

**Operation Function**

SD7005 has five control inputs : Turn off, Wind speed, Wind mode, Timer setting, Head swing. The control signal can be input by the keypads. When the control signals besides "Turn off" are received, the control system echoes an "Bi" voice. If any two keys or more are simultaneously pressed, neither of the corresponding functions will be activated. If any key is kept on depressing over 6 seconds, the fan controller will automatically echo four warning "Bi"s and power off.

The "Speed" starts the fan, then the speed is at "Strong Wind" for 3 second and then change to "Soft Wind" . Pushing "Speed" key, the sequence of the wind speed is "Soft → Medium → Strong". The sequence of the "Mode" is "Constant → Rhythmical → Sleep". Detailed function graph is shown below.

**Function Graph**

- Rhythmical Wind mode programmed with speed : (  $t = 6\text{sec}$  )

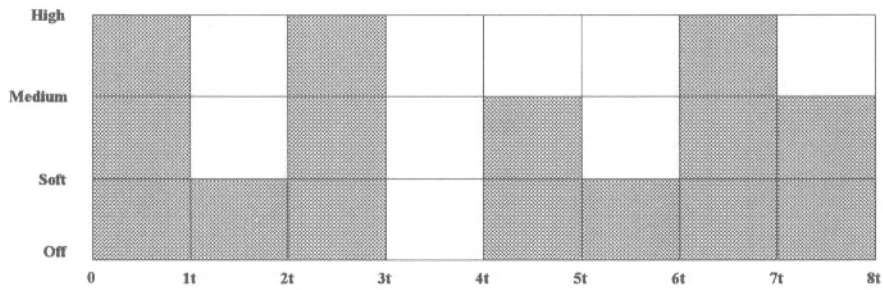
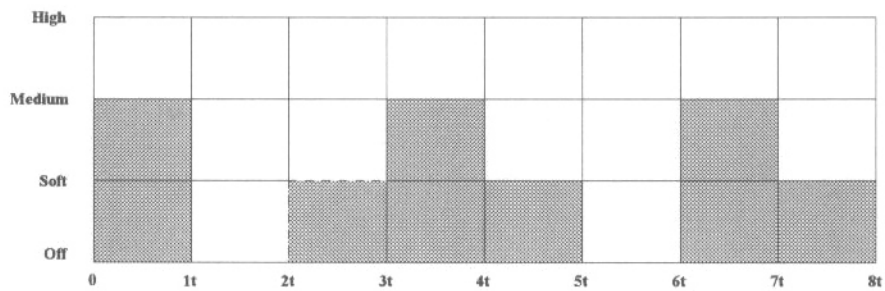
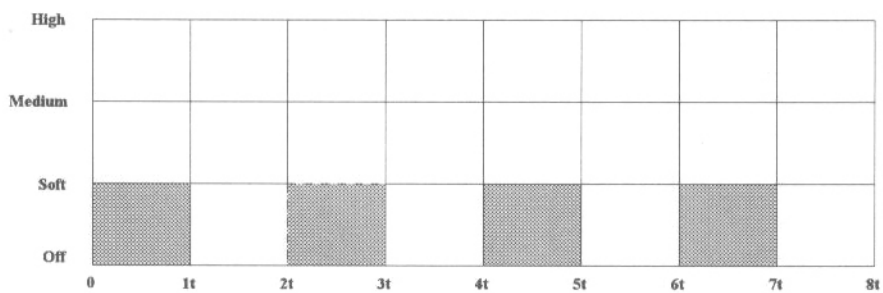
**Strong-Rhythmical Wind**

**Medium-Rhythmical Wind**

**Soft-Rhythmical Wind**

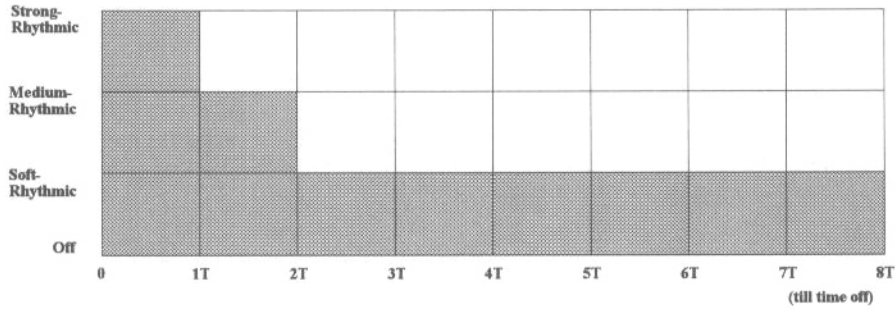

• Sleep Wind: ( T = 0.5hr )

**Strong-Sleep Wind**



**Medium-Sleep Wind**

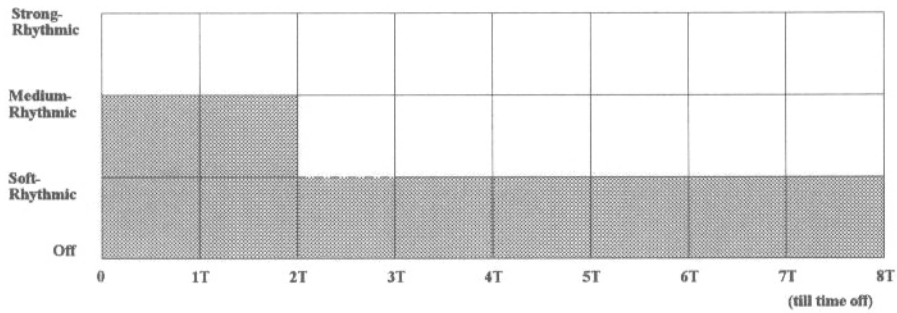

**Soft-Sleep Wind**

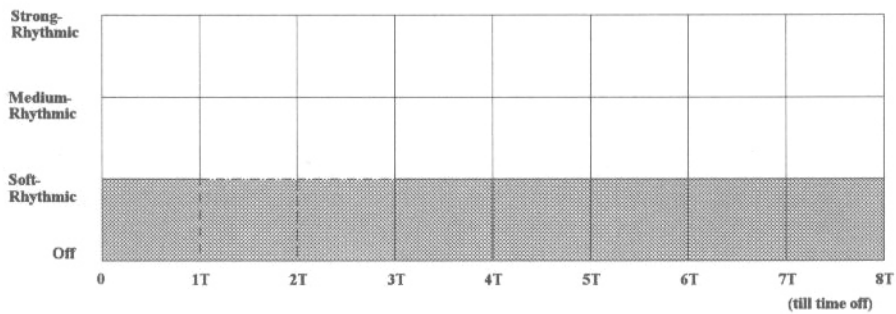

**Application Circuit**

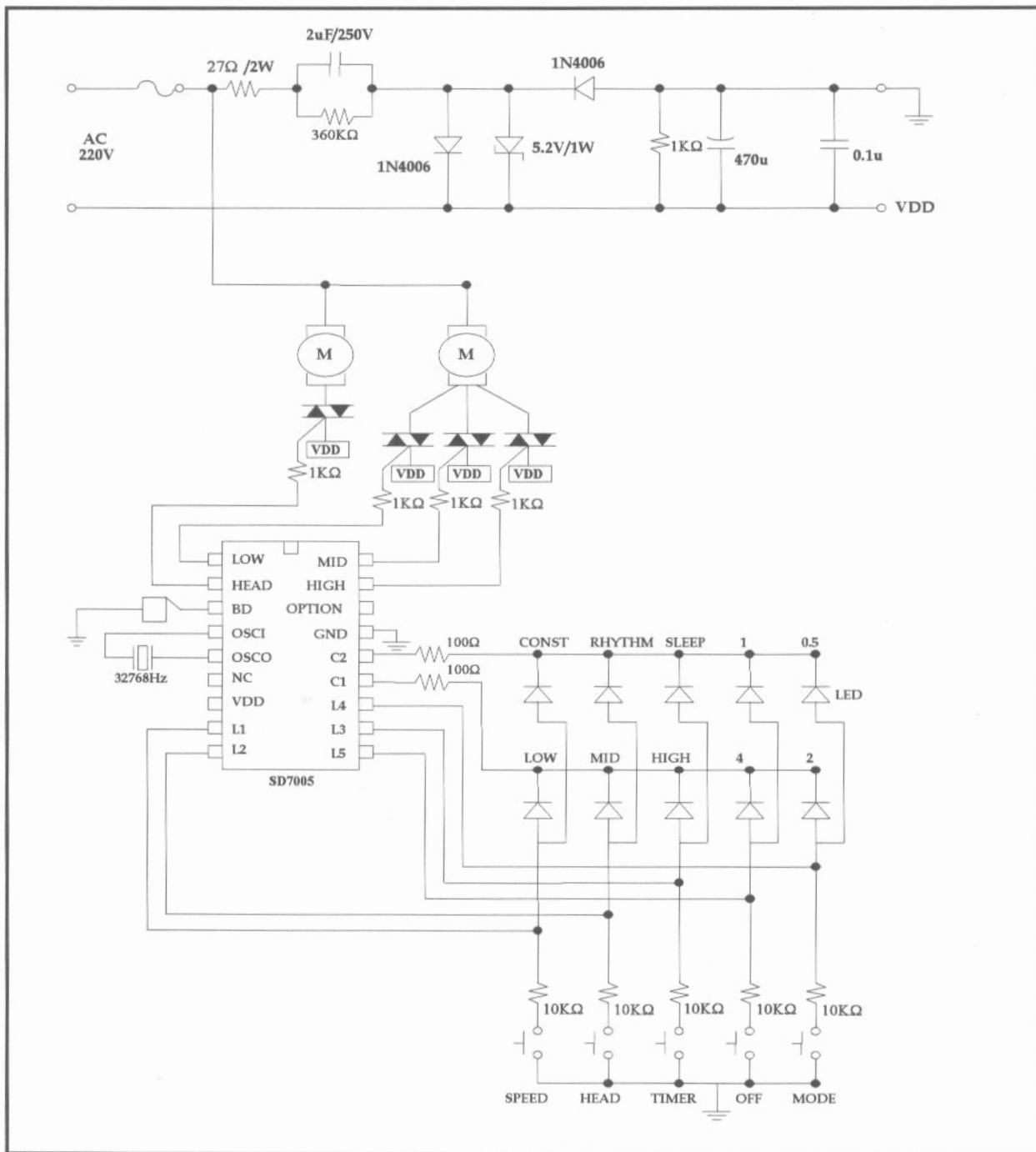

**Fig 1. SD7005 Typical Application Circuit.**



Bonding Diagram

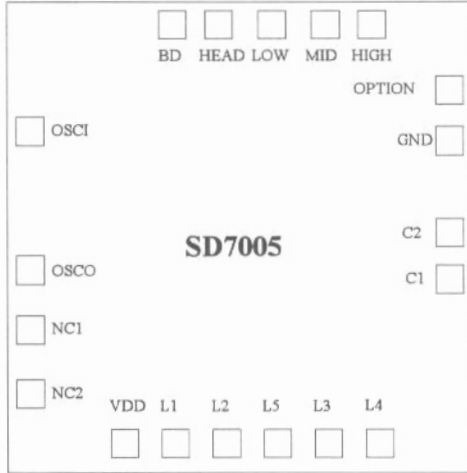

Pad No.	Pad Name	X	Y
1	LOW	73.3	83.6
2	HEAD	65.6	83.6
3	BD	57.9	83.6
4	OSCI	3.3	78.6
5	OSCO	3.3	27.7
6	NC1	3.3	20.1
7	NC2	3.3	12.5
8	VDD	47.5	3.3
9	L1	57.0	3.3
10	L2	64.4	3.3
11	L5	74.2	3.3
12	L3	81.8	3.3
13	L4	91.7	3.3
14	C1	102.1	29.9
15	C2	102.1	37.5
16	GND	102.1	69.0
17	OPTION	102.1	76.8
18	HIGH	89.3	83.6
19	MID	81.0	83.6

Unit: mil

Note: Substrate is connected to VDD