

---

***DISCRETE POWER DIODES and THYRISTORS***  
***DATA BOOK***

---

## FAST RECOVERY DIODES

### Stud Version

### Features

- High power FAST recovery diode series
- 2.0 to 3.0  $\mu$ s recovery time
- High voltage ratings up to 2500V
- High current capability
- Optimized turn on and turn off characteristics
- Low forward recovery
- Fast and soft reverse recovery
- Compression bonded encapsulation
- Stud version case style B-8
- Maximum junction temperature 150°C

400A  
450A

### Typical Applications

- Snubber diode for GTO
- High voltage free-wheeling diode
- Fast recovery rectifier applications

### Major Ratings and Characteristics

Parameters	SD453N/R		Units
	S20	S30	
$I_{F(AV)}$	400	450	A
@ $T_C$	70	70	°C
$I_{F(RMS)}$	630	710	A
$I_{FSM}$ @ 50Hz	9300	9600	A
@ 60Hz	9730	10050	A
$V_{RRM}$ range	1200 to 2500	1200 to 2500	V
$t_{rr}$	2.0	3.0	$\mu$ s
@ $T_J$	25	25	°C
$T_J$	- 40 to 150		°C

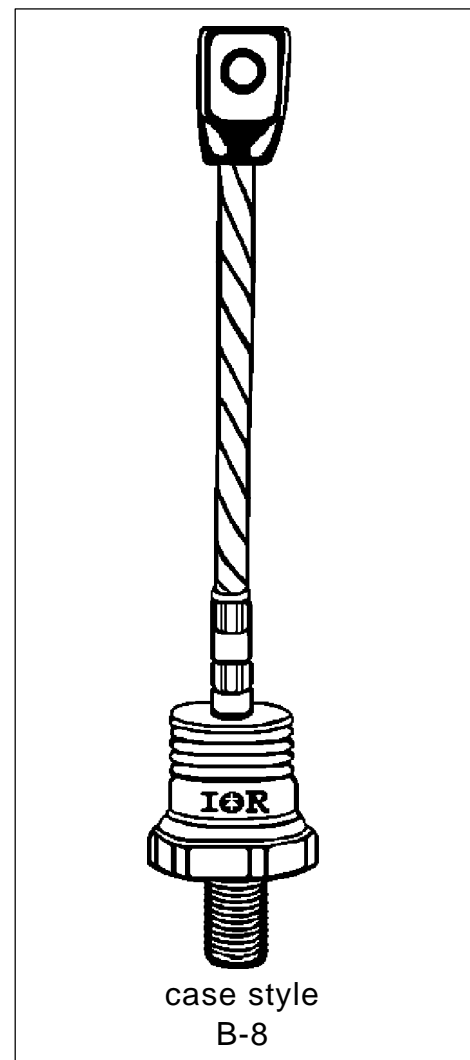

## ELECTRICAL SPECIFICATIONS

## Voltage Ratings

Type number	Voltage Code	$V_{RRM}$ , maximum repetitive peak reverse voltage V	$V_{RSM}$ , maximum non-repetitive peak rev. voltage V	$I_{RRM}$ max. @ $T_J = T_J$ max. mA
SD453N/R	12	1200	1300	50
	16	1600	1700	
	20	2000	2100	
	25	2500	2600	

## Forward Conduction

Parameter	SD453N/R		Units	Conditions		
	S20	S30				
$I_{F(AV)}$ Max. average forward current @ case temperature	400	450	A	180° conduction, half sine wave		
	70	70	°C			
$I_{F(RMS)}$ Max. RMS forward current @ case temperature	630	710	A			
	55	52	°C			
$I_{FSM}$ Max. peak, one-cycle forward, non-repetitive surge current	9300	9600	A	t = 10ms	No voltage reappplied	Sinusoidal half wave, Initial $T_J = T_J$ max.
	9730	10050		t = 8.3ms	reappplied	
	7820	8070		t = 10ms	100% $V_{RRM}$	
	8190	8450		t = 8.3ms	reappplied	
$I^2t$ Maximum $I^2t$ for fusing	432	460	KA <sup>2</sup> s	t = 10ms	No voltage reappplied	
	395	420		t = 8.3ms	reappplied	
	306	326		t = 10ms	100% $V_{RRM}$	
	279	297		t = 8.3ms	reappplied	
$I^2\sqrt{t}$ Maximum $I^2\sqrt{t}$ for fusing	4320	4600	KA <sup>2</sup> $\sqrt{s}$	t = 0.1 to 10ms, no voltage reappplied		
$V_{F(TO)1}$ Low level value of threshold voltage	1.00	0.95	V	$(16.7\% \times \pi \times I_{F(AV)} < I < \pi \times I_{F(AV)})$ , $T_J = T_J$ max.		
$V_{F(TO)2}$ High level value of threshold voltage	1.09	1.04		$(I > \pi \times I_{F(AV)})$ , $T_J = T_J$ max.		
$r_{f1}$ Low level value of forward slope resistance	0.80	0.60	m $\Omega$	$(16.7\% \times \pi \times I_{F(AV)} < I < \pi \times I_{F(AV)})$ , $T_J = T_J$ max.		
$r_{f2}$ High level value of forward slope resistance	0.74	0.54		$(I > \pi \times I_{F(AV)})$ , $T_J = T_J$ max.		
$V_{FM}$ Max. forward voltage drop	2.20	1.85	V	$I_{pk} = 1500A$ , $T_J = T_J$ max, $t_p = 10ms$ sinusoidal wave		

## Recovery Characteristics

Code	$T_J = 25^\circ\text{C}$ typical $t_{rr}$ @ 25% $I_{RRM}$ ( $\mu\text{s}$ )	Test conditions			Max. values @ $T_J = 150^\circ\text{C}$		
		$I_{pk}$ Square Pulse (A)	$di/dt$ (A/ $\mu\text{s}$ )	$V_r$ (V)	$t_{rr}$ @ 25% $I_{RRM}$ ( $\mu\text{s}$ )	$Q_{rr}$ ( $\mu\text{C}$ )	$I_{rr}$ (A)
S20	2.0	1000	50	-50	3.5	250	120
S30	3.0	1000	50	-50	5.0	380	150

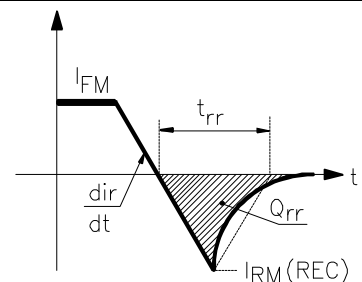

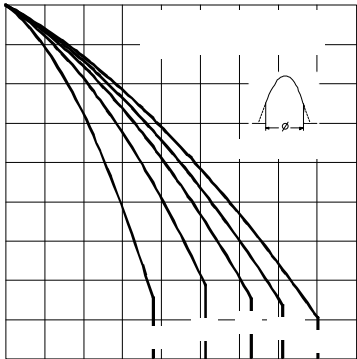

Fig. 1 - Current Ratings Characteristics

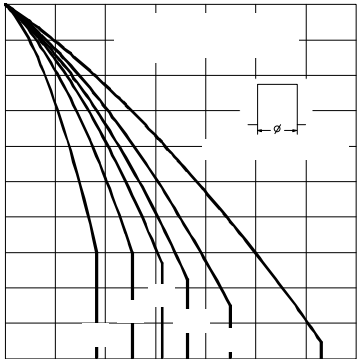

Fig. 2 - Current Ratings Characteristics

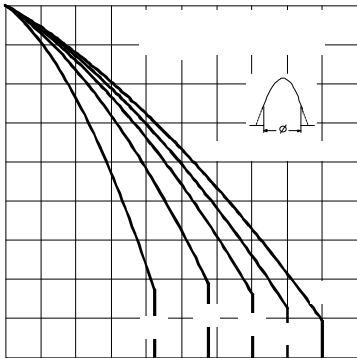

Fig. 3 - Current Ratings Characteristics

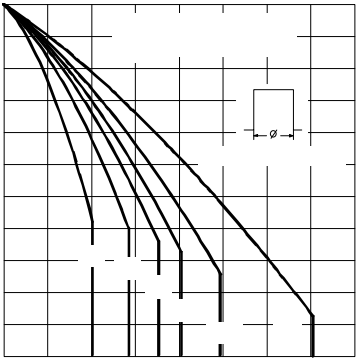

Fig. 4 - Current Ratings Characteristics

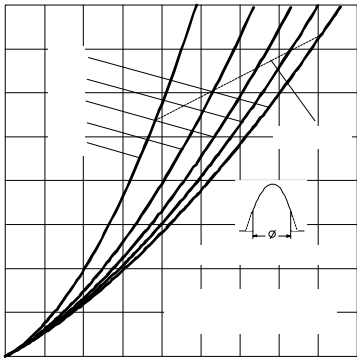

Fig. 5 - Forward Power Loss Characteristics

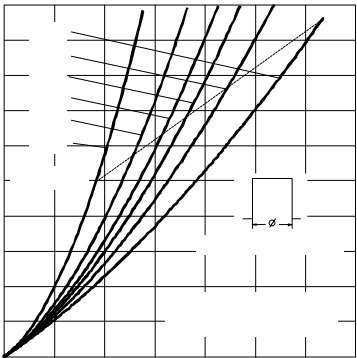

Fig. 6 - Forward Power Loss Characteristics

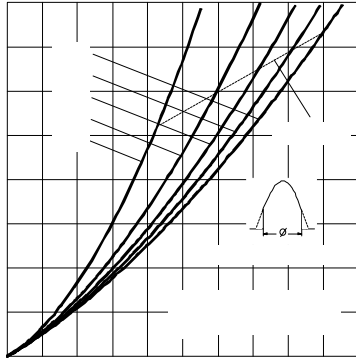

Fig. 7 - Forward Power Loss Characteristics

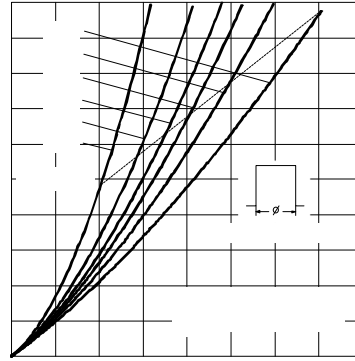

Fig. 8 - Forward Power Loss Characteristics

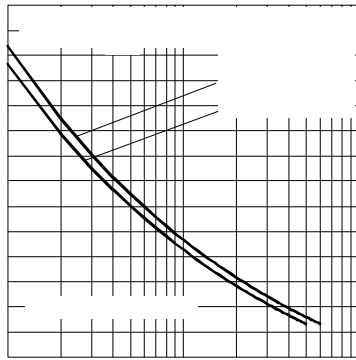

Fig. 9 - Maximum Non-repetitive Surge Current

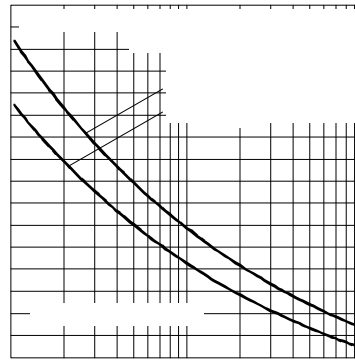

Fig. 10 - Maximum Non-repetitive Surge Current

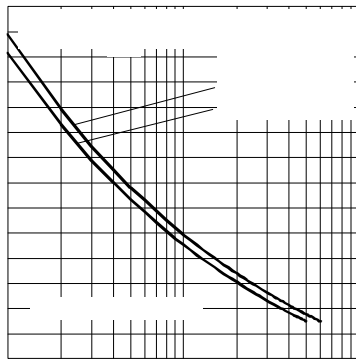

Fig. 11 - Maximum Non-repetitive Surge Current

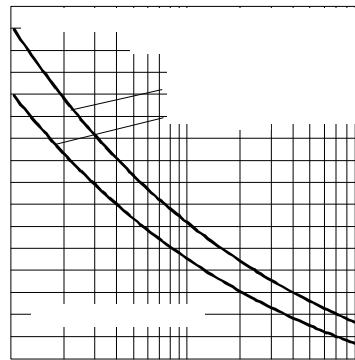

Fig. 12 - Maximum Non-repetitive Surge Current

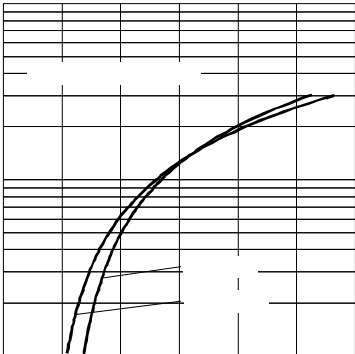

Fig. 13 - Forward Voltage Drop Characteristics

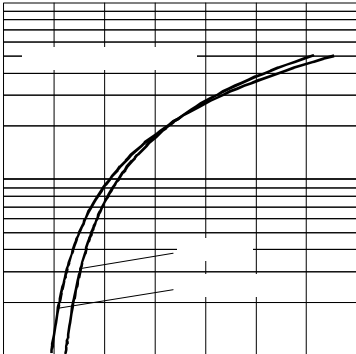

Fig. 14 - Forward Voltage Drop Characteristics

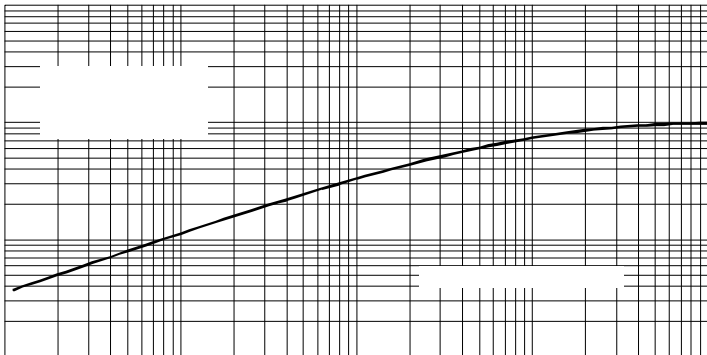

Fig. 15 - Thermal Impedance  $Z_{thJC}$  Characteristic

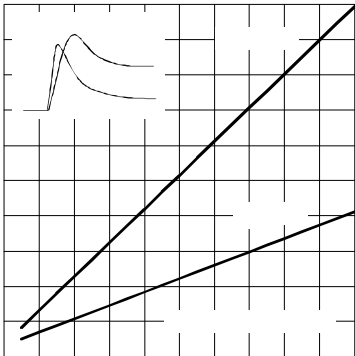

Fig. 16 - Typical Forward Recovery Characteristics

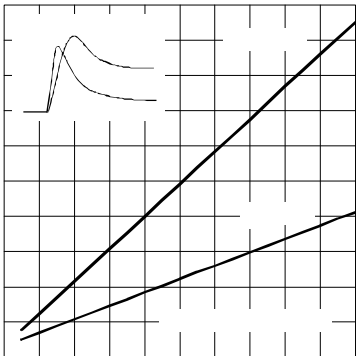

Fig. 17 - Typical Forward Recovery Characteristics

SD453N/R Series

---

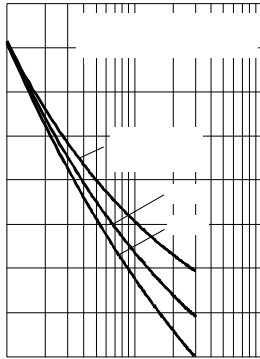

Fig. 18 - Recovery Time Characteristics

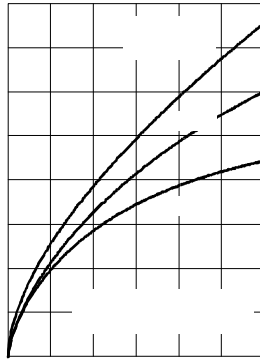

Fig. 19 - Recovery Charge Characteristics

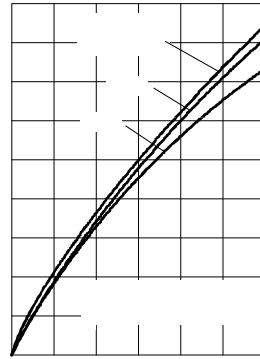

Fig. 20 - Recovery Current Characteristics

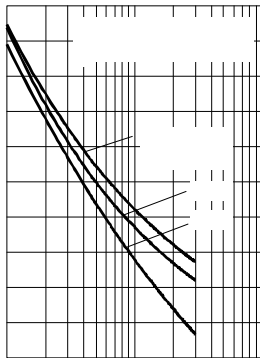

Fig. 21 - Recovery Time Characteristics

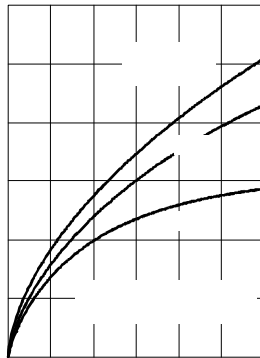

Fig. 22 - Recovery Charge Characteristics



Fig. 23 - Recovery Current Characteristics

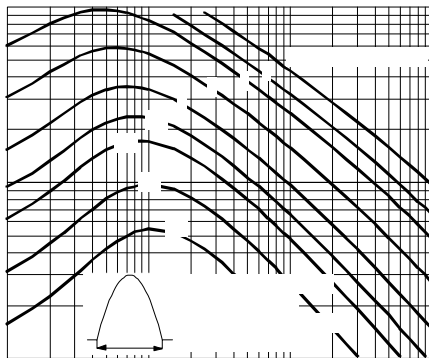

Fig. 24 - Maximum Total Energy Loss Per Pulse Characteristics

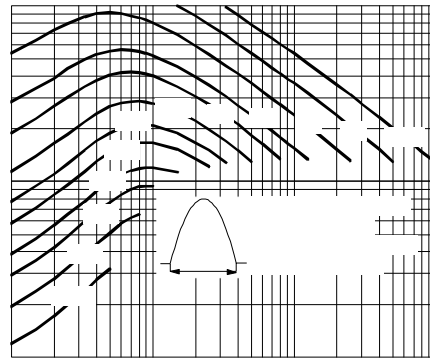

Fig. 25 - Frequency Characteristics

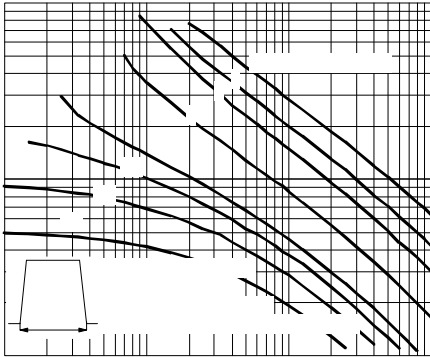

Fig. 26 - Maximum Total Energy Loss Per Pulse Characteristics

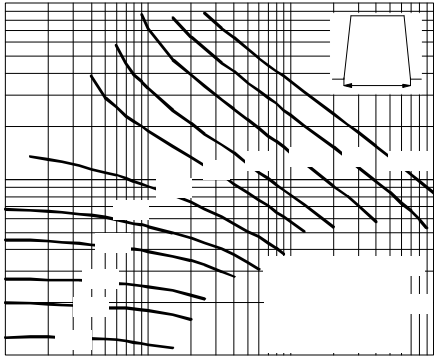

Fig. 27 - Frequency Characteristics

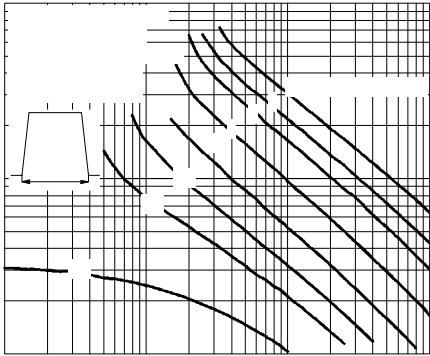

Fig. 28 - Maximum Total Energy Loss Per Pulse Characteristics

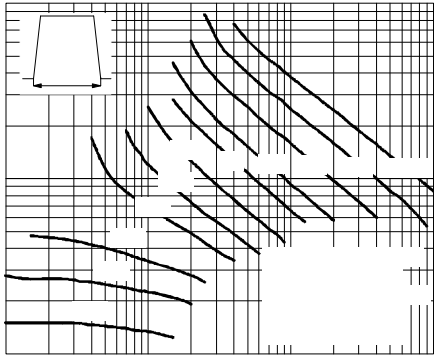

Fig. 29 - Frequency Characteristics

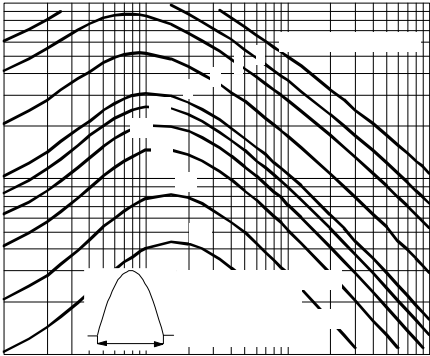

Fig. 30 - Maximum Total Energy Loss Per Pulse Characteristics

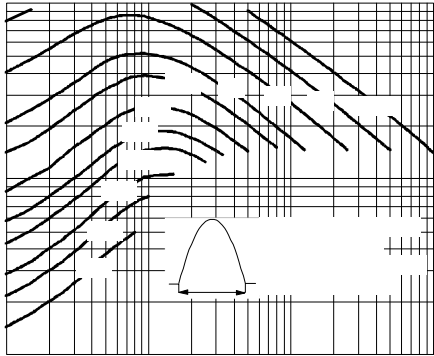

Fig. 31 - Frequency Characteristics



SD453N/R Series

---

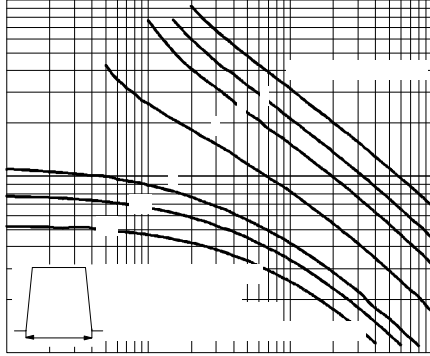

Fig. 32 - Maximum Total Energy Loss Per Pulse Characteristics

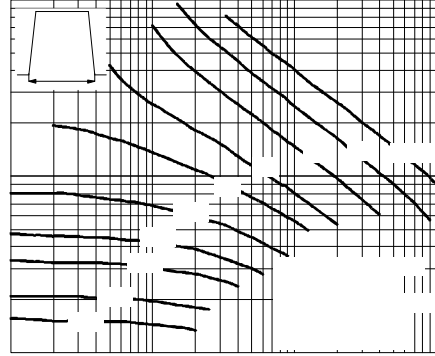

Fig. 33 - Frequency Characteristics

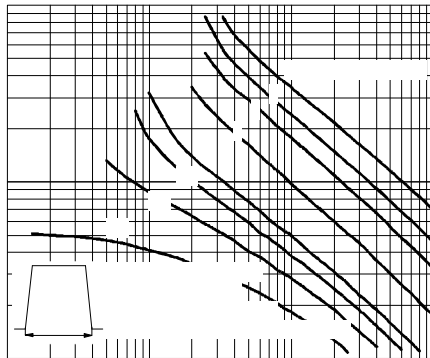

Fig. 34 - Maximum Total Energy Loss Per Pulse Characteristics

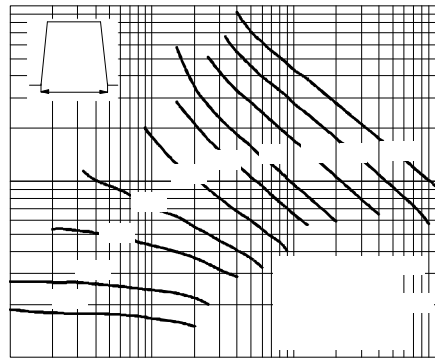

Fig. 35 - Frequency Characteristics

## Thermal and Mechanical Specifications

Parameter	SD453N/R		Units	Conditions
	S20	S30		
$T_J$ Max. junction operating temperature range	-40 to 150		°C	
$T_{stg}$ Max. storage temperature range	-40 to 150			
$R_{thJC}$ Max. thermal resistance, junction to case	0.1		K/W	DC operation
$R_{thCS}$ Max. thermal resistance, case to heatsink	0.04			Mounting surface, smooth, flat and greased
T Mounting torque, $\pm 10\%$	50		Nm	Not lubricated threads
wt Approximate weight	454		g	
Case style	B - 8			See Outline Table

 $\Delta R_{thJ-hs}$  Conduction

(The following table shows the increment of thermal resistance  $R_{thJ-hs}$  when devices operate at different conduction angles than DC)

Conduction angle	Sinusoidal conduction		Rectangular conduction		Units	Conditions
	S20	S30	S20	S30		
180°	0.010	0.010	0.008	0.008	K/W	$T_J = T_J \text{ max.}$
120°	0.014	0.014	0.014	0.014		
90°	0.017	0.017	0.019	0.019		
60°	0.025	0.025	0.026	0.026		
30°	0.042	0.042	0.042	0.042		

## Ordering Information Table

Device Code	
<b>1</b>	- Diode
<b>2</b>	- Essential part number
<b>3</b>	- 3 = Fast recovery
<b>4</b>	- N = Stud Normal Polarity (Cathode to Stud) R = Stud Reverse Polarity (Anode to Stud)
<b>5</b>	- Voltage code: Code x 100 = $V_{RRM}$ (see Voltage Ratings table)
<b>6</b>	- $t_{rr}$ code (see Recovery Characteristics table)
<b>7</b>	- P = Stud base B-8 3/4" 16UNF-2A M = Stud base B-8 M24 X 1.5
<b>8</b>	- S = Isolated lead with silicone sleeve (Red = Reverse Polarity; Blue = Normal Polarity) None = Not isolated lead T = Threaded Top Terminal 3/8" 24UNF-2A
<b>9</b>	- C = Ceramic housing

Outlines Table

CERAMIC HOUSING

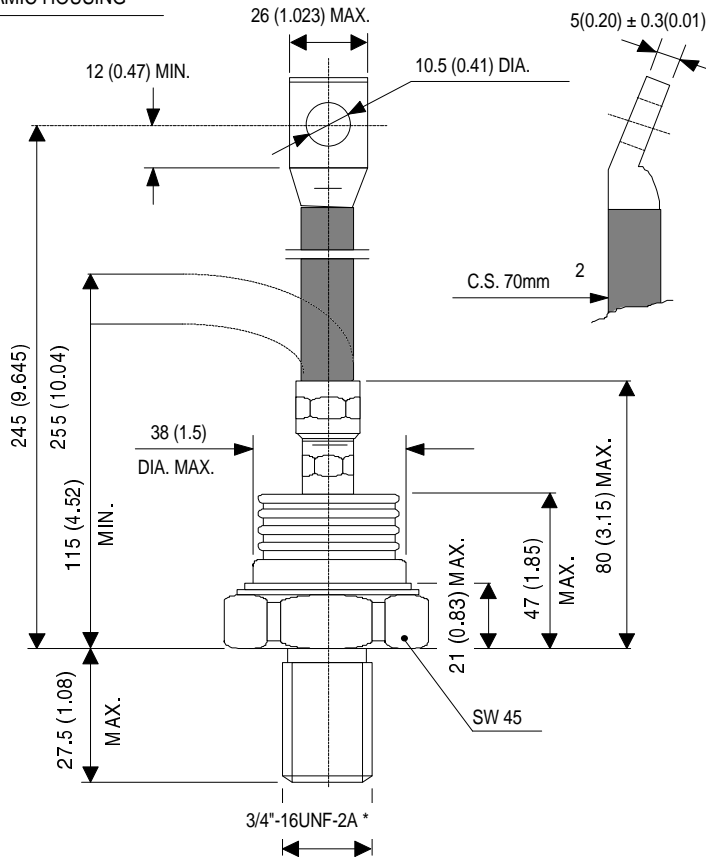

Case Style B-8  
All dimensions in millimeters (inches)

\* FOR METRIC DEVICE: M24 x 1.5 - SCREW LENGTH — 21(0.83) MAX.

CERAMIC HOUSING

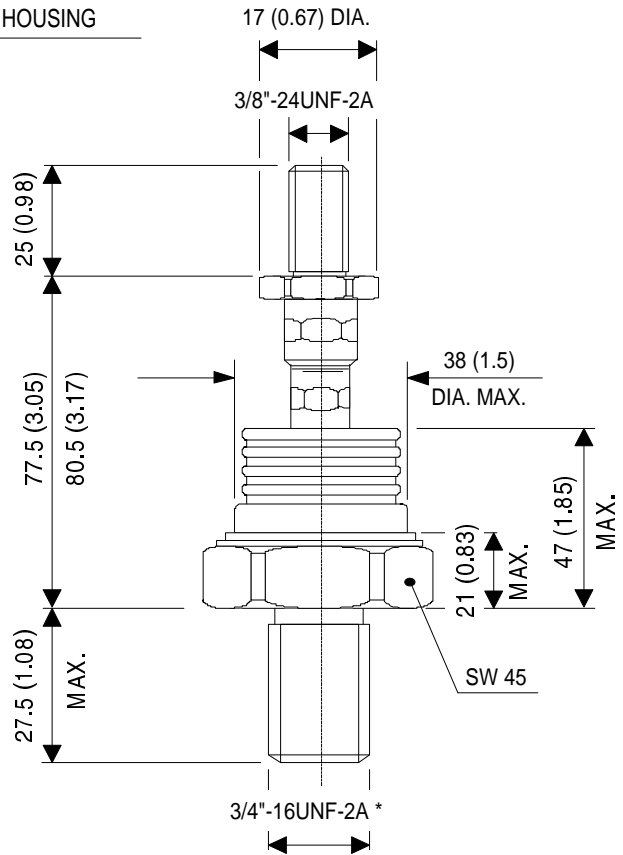

Case Style B-8 with top thread terminal 3/8"  
All dimensions in millimeters (inches)

\* FOR METRIC DEVICE: M24 x 1.5 - SCREW LENGTH — 21(0.83) MAX.