



POWER OPERATIONAL AMPLIFIER

PA30

APEX MICROTECHNOLOGY CORPORATION • APPLICATIONS HOTLINE 800 546-APEX (300-546-2739)

FEATURES

- OUTPUT POWER 2000W CONT, 8000W PULSE
- NO SECOND BREAKDOWN, MOSFET OUTPUT
- $I_o = 50A$ CONTINUOUS, 100A PULSE
- WIDE SUPPLY RANGE, 30V to 200V
- 45 V/ μ s TYPICAL SLEW RATE
- VERSATILE PROGRAMMABLE CURRENT LIMIT
- THERMAL PROTECTION, OVERTEMP OUTPUT

APPLICATIONS

- SONAR
- MAGNETIC DEFLECTION/FOCUS
- MOTOR DRIVE
- MAGNETIC BEARING CONTROL
- WELDING
- POWER SOURCE SIMULATION

DESCRIPTION

The PA30 is a high voltage, high current, high peak power operational amplifier in a hermetic, side-lead package. The power MOSFET output stage has no second breakdown limitations and is thermally protected by on-chip temperature sensors. The versatile external current limit can be configured for Kelvin sensing, as well as multi-slope foldover limiting. The Shutdown pin can be controlled by either external limiting. The Boost pins improve output voltage swing and efficiency by allowing the driver section to be operated on higher supply voltages than the output.

EQUIVALENT SCHEMATIC

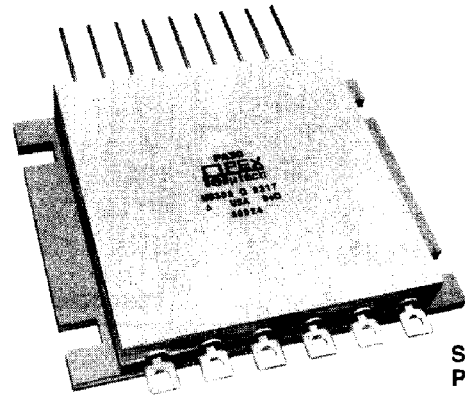
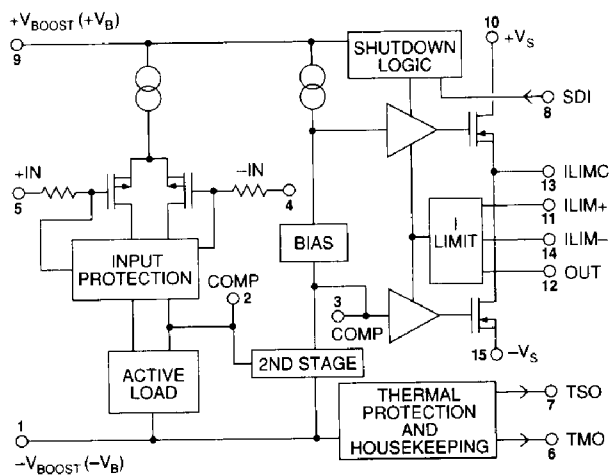

SL15 Package

PIN DESCRIPTIONS

- | | |
|---------------------------------|-----------|
| 1 $-V_{BOOST}$ | 15 $-V_S$ |
| 2 COMPENSATION 1 | 14 ILIM- |
| 3 COMPENSATION 2 | 13 ILIMC |
| 4 -INPUT | 12 OUT |
| 5 +INPUT | 11 ILIM+ |
| 6 THERMAL MONITOR OUTPUT (TMO) | 10 $+V_S$ |
| 7 THERMAL SHUTDOWN OUTPUT (TSO) | |
| 8 SHUTDOWN INPUT (SDI) | |
| 9 $+V_{BOOST}$ | |

EXTERNAL CONNECTIONS

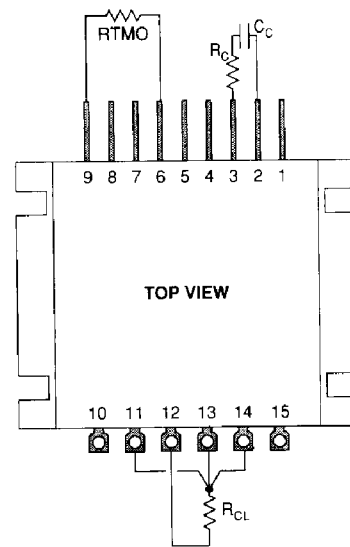

RTMO is a scaling resistor for the TMO pin (Temperature Monitor Output).

ABSOLUTE MAXIMUM RATINGS

SUPPLY VOLTAGE, $+V_S$ to $-V_S$	200V
SUPPLY VOLTAGE, $+V_B$ to $-V_B$	225V
SUPPLY VOLTAGE, V_S to V_B	12.5V
POWER DISSIPATION, $T_C = 25^\circ\text{C}$	1000W
TEMPERATURE, pin solder - 10s	300°C
TEMPERATURE, junction ^{2,5}	150°C
TEMPERATURE, storage	-65 to +150°C
PRESSURIZATION	0 to 30 PSIA

SPECIFICATIONS

PARAMETER	TEST CONDITIONS ¹	MIN	TYP	MAX	UNITS
INPUT					
OFFSET VOLTAGE, initial			5	10	mV
OFFSET VOLTAGE, vs. temperature	Full temperature range		30	50	$\mu\text{V}/^\circ\text{C}$
OFFSET VOLTAGE, vs. supply			4	20	$\mu\text{V}/\text{V}$
OFFSET VOLTAGE, vs. power	Full temperature range		30		$\mu\text{V}/\text{W}$
BIAS CURRENT, initial			10	50	pA
BIAS CURRENT, vs. supply			0.01		pA/V
OFFSET CURRENT, initial			10	50	pA
INPUT IMPEDANCE, DC			10^{11}		Ω
INPUT CAPACITANCE			15		pF
COMMON MODE VOLTAGE RANGE	Full temperature range	$+V_B-12, -V_B+5$			V
COMMON MODE REJECTION, DC		80	105		dB
INPUT NOISE	100kHz BW, $R_S = 1\text{K}\Omega$		10		μVrms
GAIN					
OPEN LOOP, 15 Hz	Full temperature range	95	110		dB
POWER BANDWIDTH			75		kHz
PHASE MARGIN	$ A_{vcl} = 8$		60		$^\circ$
OUTPUT					
VOLTAGE SWING	$I_O = 50\text{A}$	$\pm V_S-9.5$	$\pm V_S-7$		V
VOLTAGE SWING	$V_{\text{BOOST}} = 10\text{V}, I_O = 50\text{A}$	$\pm V_S-7.5$	$\pm V_S-5.0$		V
CURRENT, continuous		50			A
CURRENT, peak		100	120		A
SETTLING TIME to .1%			4		μs
SLEW RATE		30	45		V/ μs
CAPACITIVE LOAD	Full temperature range, $ A_{vcl} = 10$	22			nF
POWER SUPPLY					
VOLTAGE		± 15	± 75	± 100	V
CURRENT, quiescent	$V_{CC} = \pm 15$		28	36	mA
CURRENT, quiescent	$V_{CC} = \pm 75$		30	38	mA
CURRENT, quiescent	$V_{CC} = \pm 100$		32	40	mA
THERMAL					
RESISTANCE, AC, junction to case ³	Full temperature range, $F > 60\text{Hz}$		0.083	0.095	$^\circ\text{C}/\text{W}$
RESISTANCE, DC, junction to case	Full temperature range, $F < 60\text{Hz}$		0.114	0.125	$^\circ\text{C}/\text{W}$
RESISTANCE ⁴ , junction to air	Full temperature range		12		$^\circ\text{C}/\text{W}$
TEMPERATURE RANGE, case	Meets full range specification	-25		85	$^\circ\text{C}$

- NOTES: 1. Unless otherwise noted: $T_C = 25^\circ\text{C}$, $C_C = 68\text{pF}$, $R_C = 200$ ohms. DC input specifications are \pm value given. Power supply voltage is typical rating. $\pm V_{\text{BOOST}} = \pm V_S$.
2. Long term operation at the maximum junction temperature will result in reduced product life. Derate internal power dissipation to achieve high MTTF. For guidance, refer to the heatsink data sheet.
3. Rating applies if the output current alternates between both output transistors at a rate faster than 60 Hz.
4. The PA30 must be used with a heatsink or the quiescent power may drive the unit to junction temperatures higher than 150°C .
5. The ABSOLUTE MAXIMUM RATING for junction temperature is intended as a guideline. The thermal shutdown circuitry controls excursions beyond 150°C .

CAUTION

The PA30 is constructed from MOSFET transistors. ESD handling procedures must be observed.

The internal substrate contains beryllia (BeO). Do not break the seal. If accidentally broken, do not crush, machine, or subject to temperatures in excess of 850°C to avoid generating toxic fumes.

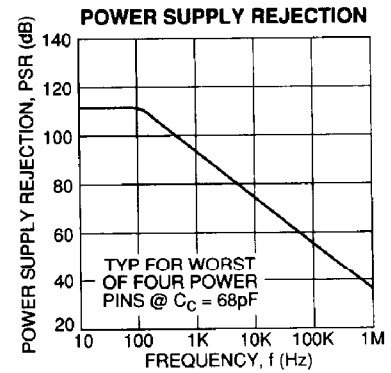
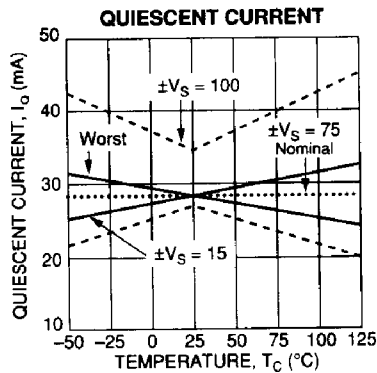
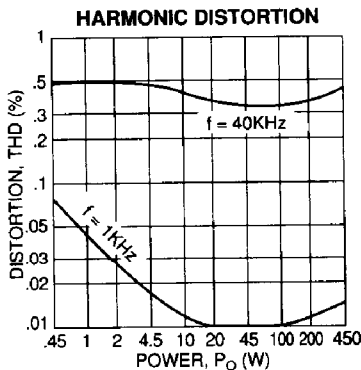
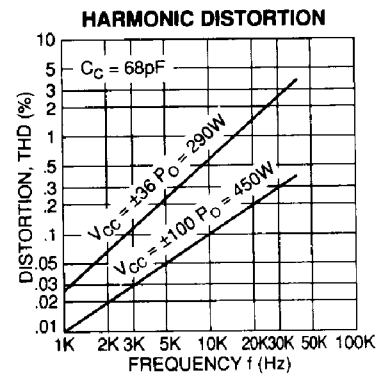
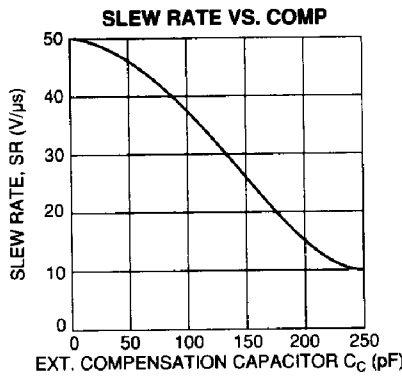
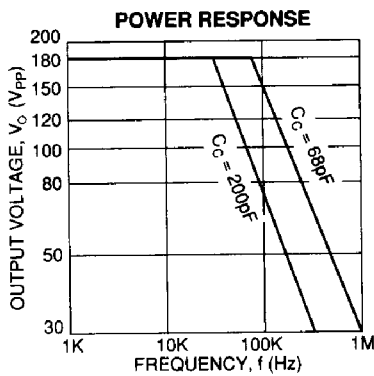
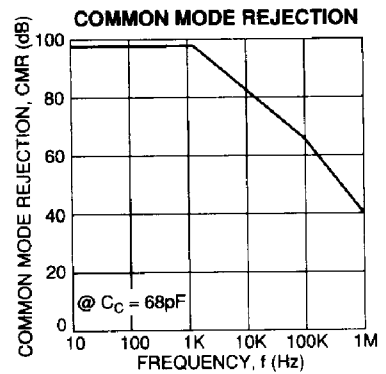
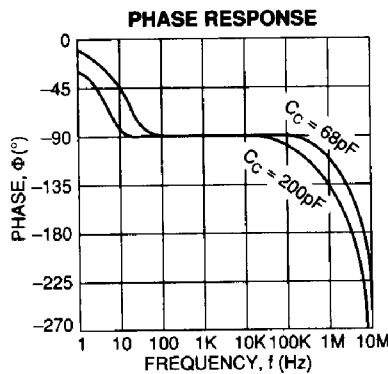
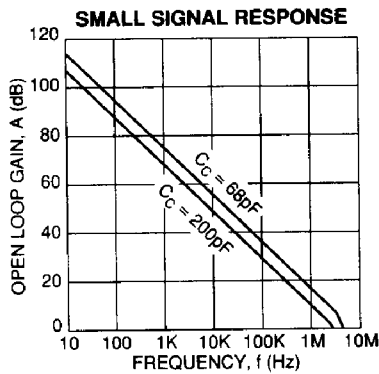
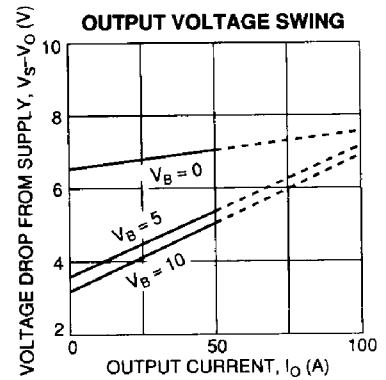
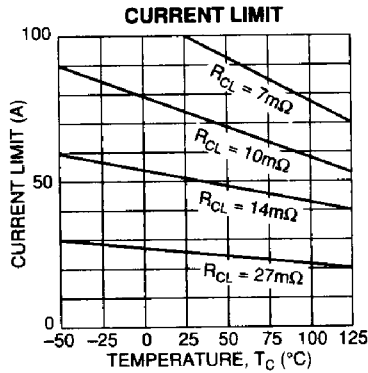
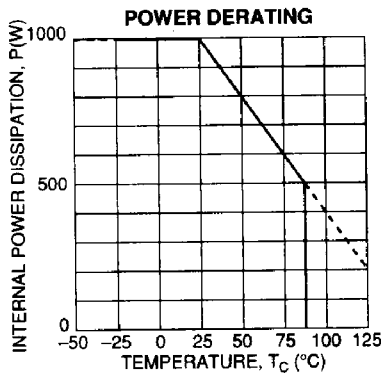

GENERAL

Please read the "General Operating Considerations" section, which covers stability, supplies, heatsinking, mounting, current limit, SOA interpretation, and specification interpretation. Additional information can be found in the application notes. For information on the package outline, heatsinks, and mounting hardware, consult the "Accessory and Package Mechanical Data" section of the handbook.

SAFE OPERATING AREA (SOA)

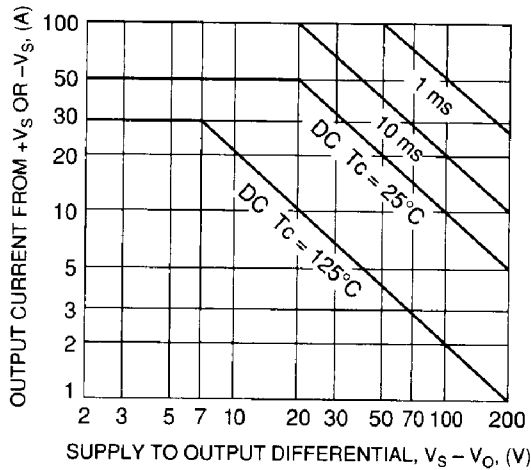

PA30 OUTPUT CURRENT

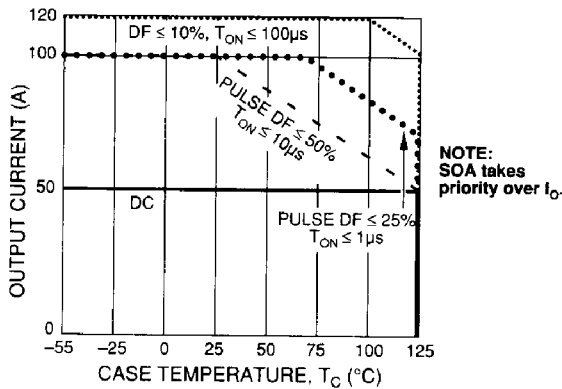

MOUNTING AND HANDLING

PA30 units are static sensitive devices and should be handled accordingly. **PA30 units should only be mounted to HS12 or to a custom heatsink providing direct liquid contact with the base of the PA30.** Please refer to the "Accessories Information" data sheet to select coolant mixtures and flow rates for power dissipation up to 1000W DC and

1300W AC. Not providing direct liquid contact will limit internal power dissipation to 400 watts. This capability will degrade if the heatsink flatness exceeds 2 mils per inch or if the thermal grease is over 1 mil thick.

CURRENT LIMIT

The PA30 allows Kelvin sensing of output current and has separate pins for positive and negative current limit. Kelvin sensing increases accuracy at high current limit values when the value of the current limit resistor becomes quite small. Separate positive and negative sections allow complex foldover limiting for maximum protection.

FIGURE 1. I_{LIMIT} WHERE $I_{CL+} = I_{CL-}$

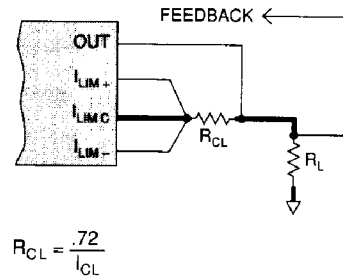

$$R_{CL} = \frac{.72}{I_{CL}}$$

FIGURE 2. I_{LIMIT} WHERE $I_{CL+} \neq I_{CL-}$

When doing unbalanced current limit, watch for voltage drop on R_{CL} , dissipation in R_{CL} , and reduced effective swing.

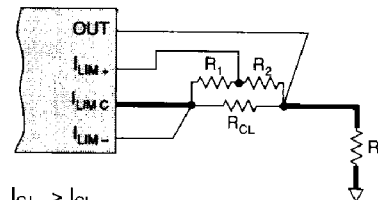

$$I_{CL+} > I_{CL-}$$

$$R_{CL} = \frac{.72}{I_{CL-}}$$

$$R_2 \approx R_{CL} \cdot 100$$

$$K = \left(\frac{I_{CL-}}{I_{CL+}} \right) - 1$$

$$R_1 = R_2 \cdot K$$

$$R_1 \leq 100\Omega$$

$$R_2 \leq 100\Omega$$

Typical maximum unbalance is $\approx 8:1$.

FIGURE 3. I_{LIMIT} WHERE $I_{CL+} \neq I_{CL-}$
When doing unbalanced current limit, watch for voltage drop on R_{CL} and dissipation in R_{CL} .

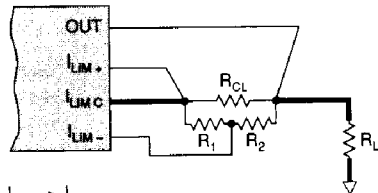

$$I_{CL-} > I_{CL+}$$

$$R_{CL} = \frac{.72}{I_{CL+}}$$

$$R_2 \approx R_{CL} \cdot 100$$

$$K = \left(\frac{I_{CL+}}{I_{CL-}} \right) - 1$$

$$R_1 = R_2 \cdot K$$

$$R_1 \leq 100\Omega$$

$$R_2 \leq 100\Omega$$

Typical maximum unbalance is $\approx 8:1$.

FOLDOVER I_{LIMIT}

Foldover I_{LIMIT} , if used in conjunction with the internal PA30 thermal protection, will make the PA30 virtually indestructible. The idea of foldover limit is to modify the value of current limit instantaneously so the product of $I^2 \cdot V$ never exceeds the SOA of the PA30. This must be done independently for each half of the output stage. A typical two-slope network is shown below. With reactive loads the amount of limiting may have to be relaxed, and high speed clamp diodes provided from the output stage power rails and pin 13. The performance of the circuit shown in Figure 4 is shown in Figure 5.

FIGURE 4. FOLDOVER CURRENT LIMIT

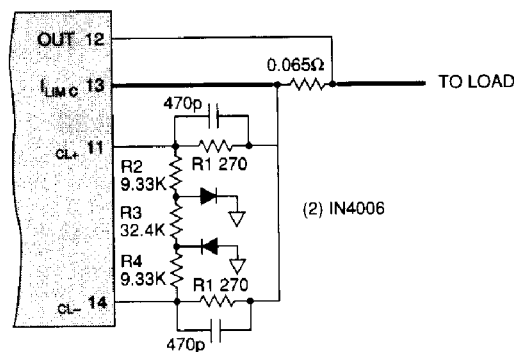

DESIGN STEPS

1. Set R_{CL} to safely limit current during a short to ground.
 $R_{CL} = 0.72/I_{OUT}$.
2. Calculate a minimum value for the sum of $R_2 + R_3$.
 $R_2 + R_3 = V_S \cdot 375$
3. Select a current limit value at maximum output.
4. Calculate V_{DROP} on R_{CL} at maximum output.
 $V_{DROP} = I_{OUT} \cdot R_{CL}$.
5. $R_2 = \max V_{OUT} / (\max V_{DROP} - .72) / 270$.
6. $R_3 = \text{Total value} - R_2$.

Note: 270 ohms is recommended for R_1 . Step 2 is based on this value.

FIGURE 5.

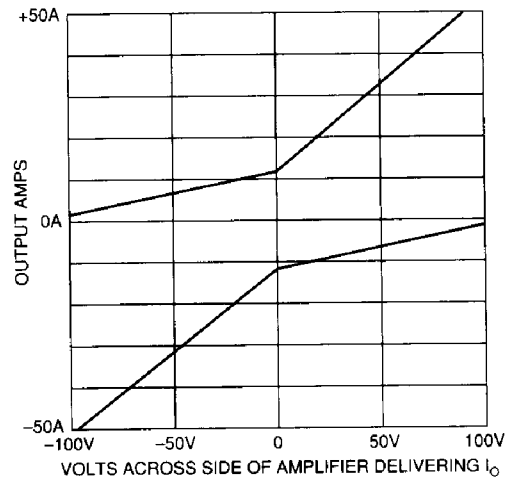

OPERATING CONSIDERATIONS

Bypassing: The V_{BOOST} pins should be bypassed close to the package consisting of two paralleled ceramic caps with values of 1000pf and .01 μ F. The V_S pins should be bypassed close to the package. The bypass should consist of one ceramic capacitor with a .01 μ F value, paralleled with one 1 μ F ceramic capacitor per 10A of output current (i.e., SOA implies five 1 μ F capacitors in parallel). Do not use electrolytic or liquid tantalum capacitors.

Thermal Monitor Output: This is an analog current that sinks from the TMO pin to the $-V_{BOOST}$ pin. Far end return may be to ground if $-V_{BOOST}$ is at least 15V or to $+V_{BOOST}$ at any time. Scaling on this output is 0.01mA per Kelvin. The temperature reported at any instant is the hotter of the top of silicon temperatures in the two output stage halves of the PA30.

Thermal Shutdown Output: This is a flag output indicating that top of silicon temperature has exceeded 160°C. This output is normally in an open circuit, but will become a current source (sink) to $-V_{BOOST}$ when active. Nominal current is 4mA. Limits are 2.4mA and 5mA. This flag will reset when the die temperature cools approximately 16°C.

Shutdown Input: This is a flag input to shut down the output stages of the PA30. This is a current sensitive input reference to $+V_{BOOST}$. Nominal activation current is 4mA. Limits are 1.2mA and 10mA. Use caution when commanding shutdown if the amplifier has an inductive loads, as large transients could occur at the output. Do not sink more than 15mA under any conditions.

USE OF TMO, SDI, TSO

When two PA30 units are used in a bridge or parallel configuration where the shutdown of one unit increases the dissipation in the other, it is desirable to shut both down at the same time. If no external shutdowns are being used, up to two PA30 units can be slaved together as shown in Figure 6. Both PA30 units must be strapped to the same $+V_{BOOST}$ and $-V_{BOOST}$ lines. A continuous overload condition will cause the PA30 to oscillate in and out of shutdown. A typical frequency would be on the order of 1Hz.

Figures 7 and 8 show a simple thermal protection configuration. Figure 9 shows an approach that allows for additional user logic control of the shutdown features. Figures 10 and 11 show thermal shutdown not used. This is not recommended.

FIGURE 6. MASTER/SLAVE USE OF TSO/SDI LOOP

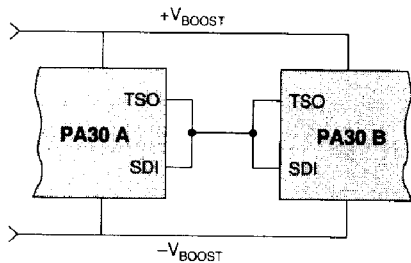

FIGURE 7. SIMPLE TSO/SDI LOOP

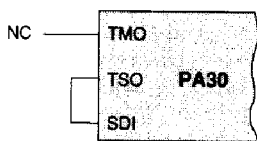

FIGURE 8. SIMPLE TSO/SDI LOOP

RTMO may be terminated at ground or $+V_{BOOST}$. At a maximum current of 5mA, the voltage on the TMO pin must be 15V more positive than $-V_{BOOST}$.

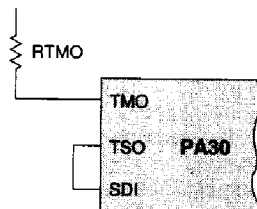
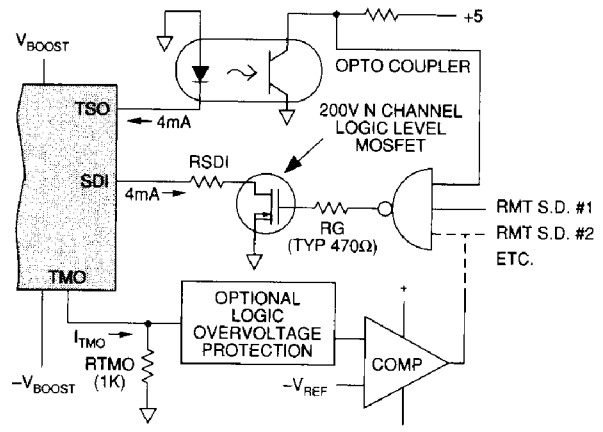

FIGURE 9. EXTERNALLY CONTROLLED THERMAL PROTECTION



$$RSDI = \frac{|+V_{BOOST}| - 11V}{0.006}$$

FIGURE 10.

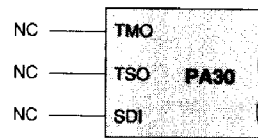
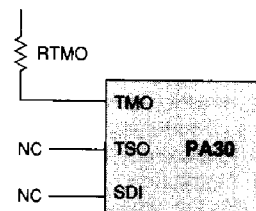

FIGURE 11.



SLEW RATE

The PA30 input stage design is such that an input differential drive voltage of ≈ 3.5 volts is required to achieve rated slew rate for any given value of compensation. This will generally place a practical upper limit on closed loop gain. Of course, phase margin limits will place a practical lower limit on closed loop gain if compensated for maximum slew rate.

POWER SUPPLY VENDORS FOR PA30

Dynapower Corp.

P.O. Box 3180, Farmington Hills, MI 48333
(313) 553-4300

Power Ten

486 Mercury Drive, Sunnyvale, CA 94086
(408) 738-5959

Sorensen Company

5555 N. Elston Avenue, Chicago, IL 60630
(800) 525-2024