

# MMBT2369LT1, MMBT2369ALT1

MMBT2369ALT1 is a Preferred Device

## Switching Transistors

### NPN Silicon

#### Features

- Pb-Free Packages are Available

#### MAXIMUM RATINGS

Rating	Symbol	Value	Unit
Collector-Emitter Voltage	$V_{CEO}$	15	Vdc
Collector-Emitter Voltage	$V_{CES}$	40	Vdc
Collector-Base Voltage	$V_{CBO}$	40	Vdc
Emitter-Base Voltage	$V_{EBO}$	4.5	Vdc
Collector Current - Continuous	$I_C$	200	mAdc

#### THERMAL CHARACTERISTICS

Characteristic	Symbol	Max	Unit
Total Device Dissipation FR-5 Board (Note 1) $T_A = 25^\circ\text{C}$ Derate above $25^\circ\text{C}$	$P_D$	225 1.8	mW mW/ $^\circ\text{C}$
Thermal Resistance, Junction-to-Ambient	$R_{\theta JA}$	556	$^\circ\text{C}/\text{W}$
Total Device Dissipation Alumina Substrate, (Note 2) $T_A = 25^\circ\text{C}$ Derate above $25^\circ\text{C}$	$P_D$	300 2.4	mW mW/ $^\circ\text{C}$
Thermal Resistance, Junction-to-Ambient	$R_{\theta JA}$	417	$^\circ\text{C}/\text{W}$
Junction and Storage Temperature	$T_J, T_{stg}$	-55 to +150	$^\circ\text{C}$

Stresses exceeding Maximum Ratings may damage the device. Maximum Ratings are stress ratings only. Functional operation above the Recommended Operating Conditions is not implied. Extended exposure to stresses above the Recommended Operating Conditions may affect device reliability.

- FR-5 =  $1.0 \times 0.75 \times 0.062$  in.
- Alumina =  $0.4 \times 0.3 \times 0.024$  in. 99.5% alumina.



ON Semiconductor®

<http://onsemi.com>

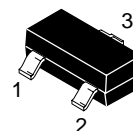
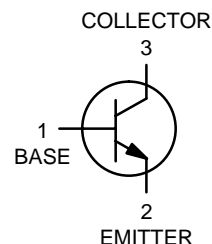

SOT-23  
CASE 318  
STYLE 6

#### MARKING DIAGRAMS

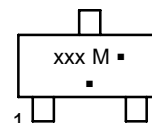

xxx = M1J or 1JA  
M = Date Code\*  
▪ = Pb-Free Package

(Note: Microdot may be in either location)

\*Date Code orientation and/or overbar may vary depending upon manufacturing location.

#### ORDERING INFORMATION

Device	Package	Shipping
MMBT2369LT1	SOT-23	3000/Tape & Reel
MMBT2369LT1G	SOT-23 (Pb-Free)	3000/Tape & Reel
MMBT2369ALT1	SOT-23	3000/Tape & Reel
MMBT2369ALT1G	SOT-23 (Pb-Free)	3000/Tape & Reel

†For information on tape and reel specifications, including part orientation and tape sizes, please refer to our Tape and Reel Packaging Specifications Brochure, BRD8011/D.

Preferred devices are recommended choices for future use and best overall value.

# MMBT2369LT1, MMBT2369ALT1

## ELECTRICAL CHARACTERISTICS (T<sub>A</sub> = 25°C unless otherwise noted)

Characteristic	Symbol	Min	Typ	Max	Unit
<b>OFF CHARACTERISTICS</b>					
Collector–Emitter Breakdown Voltage (Note 3) (I <sub>C</sub> = 10 mAdc, I <sub>B</sub> = 0)	V <sub>(BR)CEO</sub>	15	–	–	Vdc
Collector–Emitter Breakdown Voltage (I <sub>C</sub> = 10 μAdc, V <sub>BE</sub> = 0)	V <sub>(BR)CES</sub>	40	–	–	Vdc
Collector–Base Breakdown Voltage (I <sub>C</sub> = 10 μAdc, I <sub>E</sub> = 0)	V <sub>(BR)CBO</sub>	40	–	–	Vdc
Emitter–Base Breakdown Voltage (I <sub>E</sub> = 10 μAdc, I <sub>C</sub> = 0)	V <sub>(BR)EBO</sub>	4.5	–	–	Vdc
Collector Cutoff Current (V <sub>CB</sub> = 20 Vdc, I <sub>E</sub> = 0) (V <sub>CB</sub> = 20 Vdc, I <sub>E</sub> = 0, T <sub>A</sub> = 150°C)	I <sub>CBO</sub>	– –	– –	0.4 30	μAdc
Collector Cutoff Current (V <sub>CE</sub> = 20 Vdc, V <sub>BE</sub> = 0)	I <sub>CES</sub>	–	–	0.4	μAdc

## ON CHARACTERISTICS

DC Current Gain (Note 3) (I <sub>C</sub> = 10 mAdc, V <sub>CE</sub> = 1.0 Vdc) (I <sub>C</sub> = 10 mAdc, V <sub>CE</sub> = 1.0 Vdc) (I <sub>C</sub> = 10 mAdc, V <sub>CE</sub> = 0.35 Vdc) (I <sub>C</sub> = 10 mAdc, V <sub>CE</sub> = 0.35 Vdc, T <sub>A</sub> = –55°C) (I <sub>C</sub> = 30 mAdc, V <sub>CE</sub> = 0.4 Vdc) (I <sub>C</sub> = 100 mAdc, V <sub>CE</sub> = 2.0 Vdc) (I <sub>C</sub> = 100 mAdc, V <sub>CE</sub> = 1.0 Vdc)	MMBT2369 MMBT2369A MMBT2369A MMBT2369A MMBT2369A MMBT2369 MMBT2369A	h <sub>FE</sub>	40 – 40 20 30 20 20	– – – – – – –	120 120 – – – – –	–
Collector–Emitter Saturation Voltage (Note 3) (I <sub>C</sub> = 10 mAdc, I <sub>B</sub> = 1.0 mAdc) (I <sub>C</sub> = 10 mAdc, I <sub>B</sub> = 1.0 mAdc) (I <sub>C</sub> = 10 mAdc, I <sub>B</sub> = 1.0 mAdc, T <sub>A</sub> = +125°C) (I <sub>C</sub> = 30 mAdc, I <sub>B</sub> = 3.0 mAdc) (I <sub>C</sub> = 100 mAdc, I <sub>B</sub> = 10 mAdc)	MMBT2369 MMBT2369A MMBT2369A MMBT2369A MMBT2369A	V <sub>CE(sat)</sub>	– – – – –	– – – – –	0.25 0.20 0.30 0.25 0.50	Vdc
Base–Emitter Saturation Voltage (Note 3) (I <sub>C</sub> = 10 mAdc, I <sub>B</sub> = 1.0 mAdc) (I <sub>C</sub> = 10 mAdc, I <sub>B</sub> = 1.0 mAdc, T <sub>A</sub> = –55°C) (I <sub>C</sub> = 30 mAdc, I <sub>B</sub> = 3.0 mAdc) (I <sub>C</sub> = 100 mAdc, I <sub>B</sub> = 10 mAdc)	MMBT2369A MMBT2369A MMBT2369A MMBT2369A	V <sub>BE(sat)</sub>	0.7 – – –	– – – –	0.85 1.02 1.15 1.60	Vdc

## SMALL-SIGNAL CHARACTERISTICS

Output Capacitance (V <sub>CB</sub> = 5.0 Vdc, I <sub>E</sub> = 0, f = 1.0 MHz)	C <sub>obo</sub>	–	–	4.0	pF
Small Signal Current Gain (I <sub>C</sub> = 10 mAdc, V <sub>CE</sub> = 10 Vdc, f = 100 MHz)	h <sub>fe</sub>	5.0	–	–	–

## SWITCHING CHARACTERISTICS

Storage Time (I <sub>B1</sub> = I <sub>B2</sub> = I <sub>C</sub> = 10 mAdc)	t <sub>s</sub>	–	5.0	13	ns
Turn–On Time (V <sub>CC</sub> = 3.0 Vdc, I <sub>C</sub> = 10 mAdc, I <sub>B1</sub> = 3.0 mAdc)	t <sub>on</sub>	–	8.0	12	ns
Turn–Off Time (V <sub>CC</sub> = 3.0 Vdc, I <sub>C</sub> = 10 mAdc, I <sub>B1</sub> = 3.0 mAdc, I <sub>B2</sub> = 1.5 mAdc)	t <sub>off</sub>	–	10	18	ns

3. Pulse Test: Pulse Width ≤ 300 μs, Duty Cycle ≤ 2.0%.

# MMBT2369LT1, MMBT2369ALT1

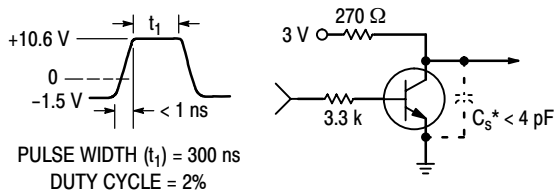

Figure 1.  $t_{on}$  Circuit – 10 mA

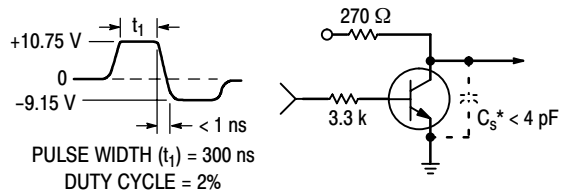

Figure 2.  $t_{off}$  Circuit – 10 mA

\*Total shunt capacitance of test jig and connectors.

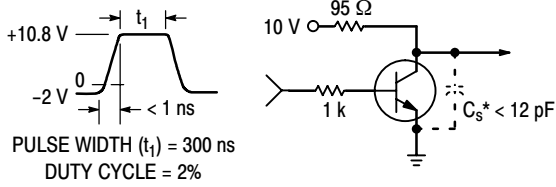

Figure 3.  $t_{on}$  Circuit – 100 mA

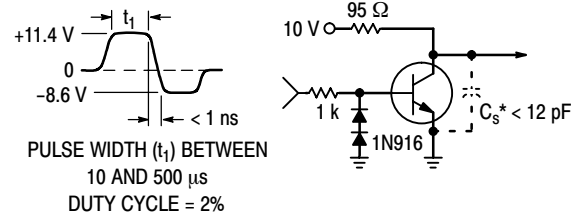
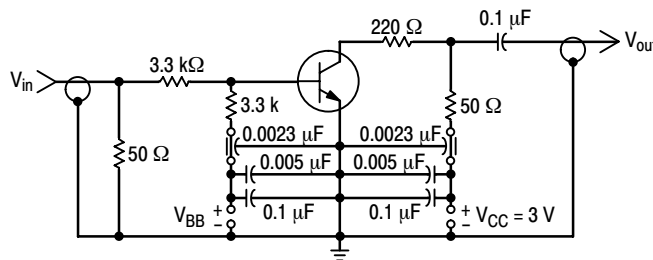
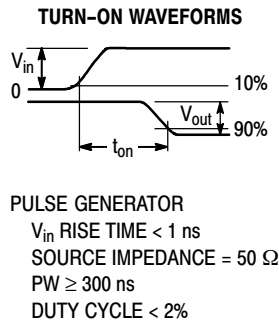

Figure 4.  $t_{off}$  Circuit – 100 mA

\*Total shunt capacitance of test jig and connectors.



TO OSCILLOSCOPE  
INPUT IMPEDANCE = 50  $\Omega$   
RISE TIME = 1 ns

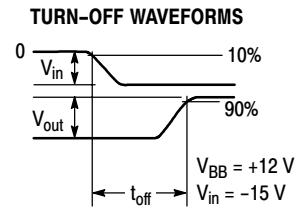

Figure 5. Turn-On and Turn-Off Time Test Circuit

# MMBT2369LT1, MMBT2369ALT1

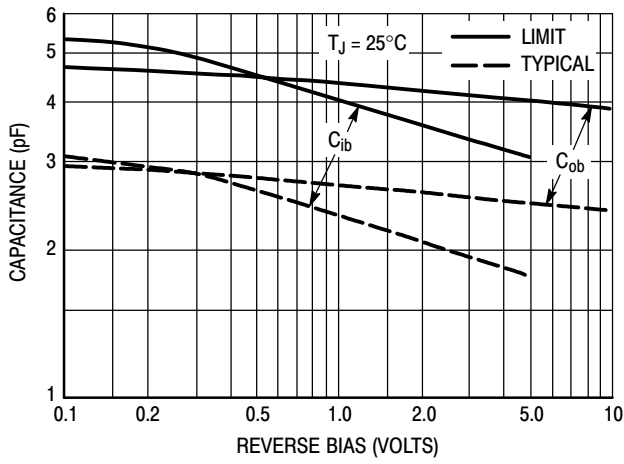

Figure 6. Junction Capacitance Variations

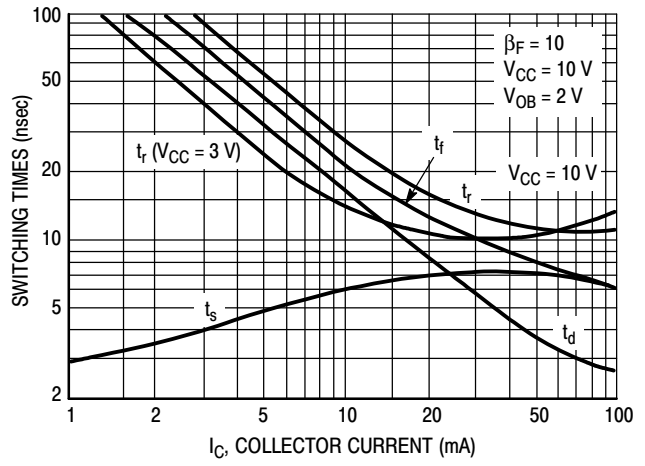

Figure 7. Typical Switching Times

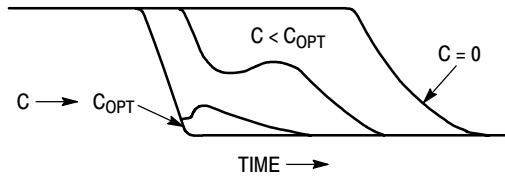

Figure 8. Turn-Off Waveform

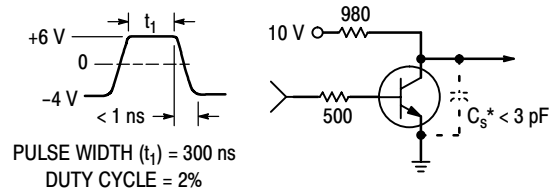

Figure 9. Storage Time Equivalent Test Circuit

# MMBT2369LT1, MMBT2369ALT1

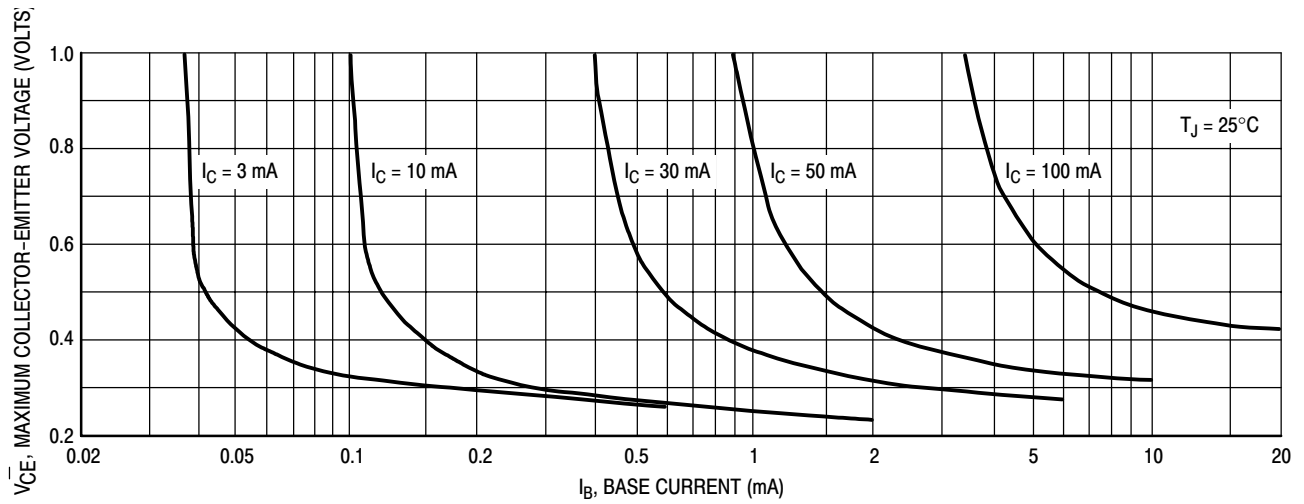

Figure 10. Maximum Collector Saturation Voltage Characteristics

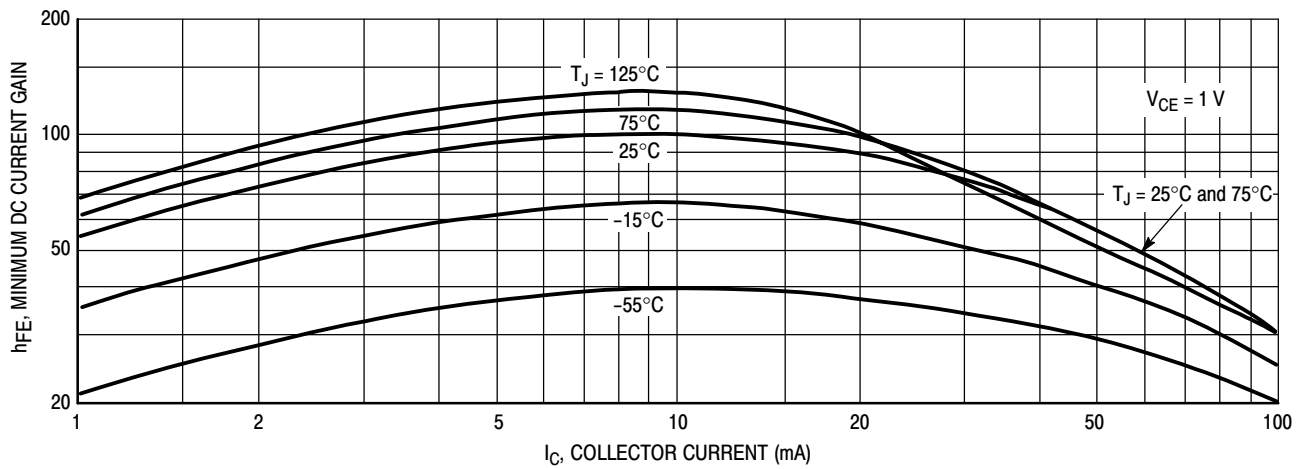

Figure 11. Minimum Current Gain Characteristics

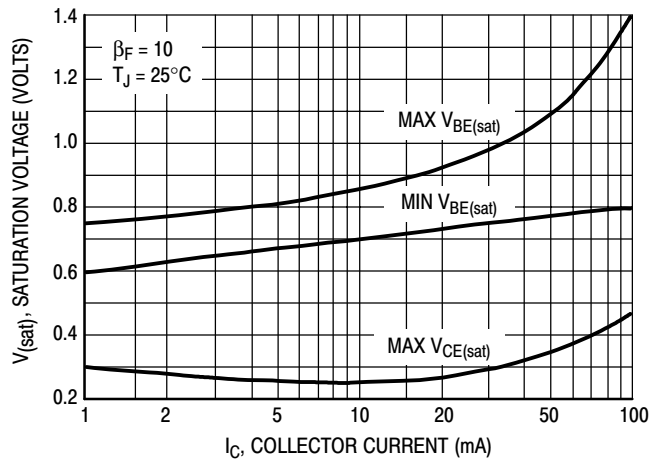
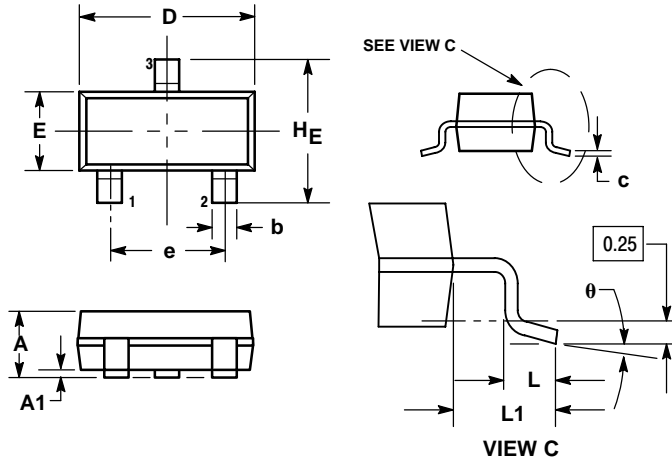

Figure 12. Saturation Voltage Limits

# MMBT2369LT1, MMBT2369ALT1

## PACKAGE DIMENSIONS

SOT-23 (TO-236)  
CASE 318-08  
ISSUE AN



NOTES:

1. DIMENSIONING AND TOLERANCING PER ANSI Y14.5M, 1982.
2. CONTROLLING DIMENSION: INCH.
3. MAXIMUM LEAD THICKNESS INCLUDES LEAD FINISH THICKNESS. MINIMUM LEAD THICKNESS IS THE MINIMUM THICKNESS OF BASE MATERIAL.
4. 318-01 THRU -07 AND -09 OBSOLETE, NEW STANDARD 318-08.

DIM	MILLIMETERS			INCHES		
	MIN	NOM	MAX	MIN	NOM	MAX
A	0.89	1.00	1.11	0.035	0.040	0.044
A1	0.01	0.06	0.10	0.001	0.002	0.004
b	0.37	0.44	0.50	0.015	0.018	0.020
c	0.09	0.13	0.18	0.003	0.005	0.007
D	2.80	2.90	3.04	0.110	0.114	0.120
E	1.20	1.30	1.40	0.047	0.051	0.055
e	1.78	1.90	2.04	0.070	0.075	0.081
L	0.10	0.20	0.30	0.004	0.008	0.012
L1	0.35	0.54	0.69	0.014	0.021	0.029
HE	2.10	2.40	2.64	0.083	0.094	0.104

STYLE 6:

1. BASE
2. EMITTER
3. COLLECTOR

### SOLDERING FOOTPRINT\*

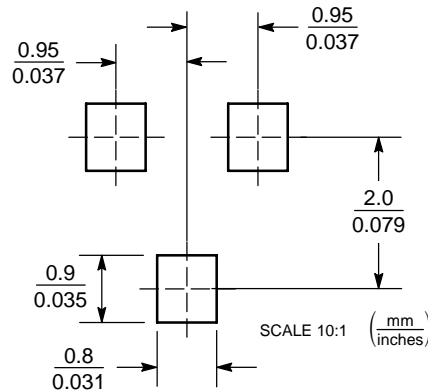

\*For additional information on our Pb-Free strategy and soldering details, please download the ON Semiconductor Soldering and Mounting Techniques Reference Manual, SOLDERRM/D.

ON Semiconductor and are registered trademarks of Semiconductor Components Industries, LLC (SCILLC). SCILLC reserves the right to make changes without further notice to any products herein. SCILLC makes no warranty, representation or guarantee regarding the suitability of its products for any particular purpose, nor does SCILLC assume any liability arising out of the application or use of any product or circuit, and specifically disclaims any and all liability, including without limitation special, consequential or incidental damages. "Typical" parameters which may be provided in SCILLC data sheets and/or specifications can and do vary in different applications and actual performance may vary over time. All operating parameters, including "Typicals" must be validated for each customer application by customer's technical experts. SCILLC does not convey any license under its patent rights nor the rights of others. SCILLC products are not designed, intended, or authorized for use as components in systems intended for surgical implant into the body, or other applications intended to support or sustain life, or for any other application in which the failure of the SCILLC product could create a situation where personal injury or death may occur. Should Buyer purchase or use SCILLC products for any such unintended or unauthorized application, Buyer shall indemnify and hold SCILLC and its officers, employees, subsidiaries, affiliates, and distributors harmless against all claims, costs, damages, and expenses, and reasonable attorney fees arising out of, directly or indirectly, any claim of personal injury or death associated with such unintended or unauthorized use, even if such claim alleges that SCILLC was negligent regarding the design or manufacture of the part. SCILLC is an Equal Opportunity/Affirmative Action Employer. This literature is subject to all applicable copyright laws and is not for resale in any manner.

### PUBLICATION ORDERING INFORMATION

LITERATURE FULFILLMENT:

Literature Distribution Center for ON Semiconductor  
P.O. Box 5163, Denver, Colorado 80217 USA  
Phone: 303-675-2175 or 800-344-3860 Toll Free USA/Canada  
Fax: 303-675-2176 or 800-344-3867 Toll Free USA/Canada  
Email: orderlit@onsemi.com

N. American Technical Support: 800-282-9855 Toll Free  
USA/Canada  
Europe, Middle East and Africa Technical Support:  
Phone: 421 33 790 2910  
Japan Customer Focus Center  
Phone: 81-3-5773-3850

ON Semiconductor Website: [www.onsemi.com](http://www.onsemi.com)

Order Literature: <http://www.onsemi.com/orderlit>

For additional information, please contact your local Sales Representative