

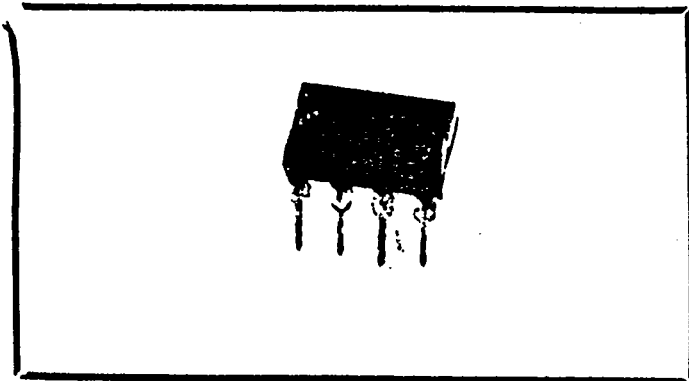

MA-332

AUDIO OPERATIONAL AMPLIFIER

T-74-05-01



GENERAL DESCRIPTION

MA-332 is a bipolar, monolithic operational amplifier having a differential input stage and a complimentary output stage. The gain stages have been designed for the greatest possible linearity. The output stage produces sufficient drive for 600 ohm loads.

Noise voltage has been minimized by input stage design, which also provides low, untrimmed input offset voltage. Anti-parallel diodes across the inputs are used to protect the input devices against breakdown voltages or excessive base current which would deteriorate the noise characteristics.

Current limiting is provided in the output stage, which will limit current for both resistive and capacitive loads to a safe level.

FEATURES

- 0.0002% TOTAL HARMONIC DISTORTION
- ±18 VOLTS INTO 600 OHM OUTPUT SWING
- 5 nV/√Hz INPUT NOISE VOLTAGE
- ±20 V/μS SLEW RATE
- DRIVES 3nF WITH UNITY GAIN STABILITY

APPLICATIONS

- PRECISION AUDIO EQUIPMENT
- INSTRUMENTATION SYSTEMS
- DATA ACQUISITION SYSTEMS
- LINE DRIVERS

FUNCTIONAL DIAGRAM

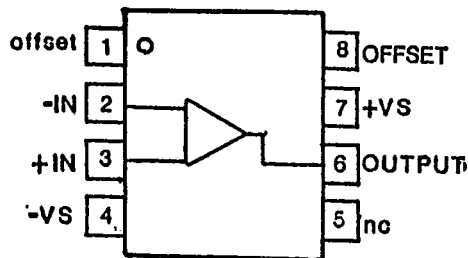

ORDER PART NUMBER MA-332-CP
EPOXY 8-PIN MINI-DIP

SIMPLIFIED SCHEMATIC

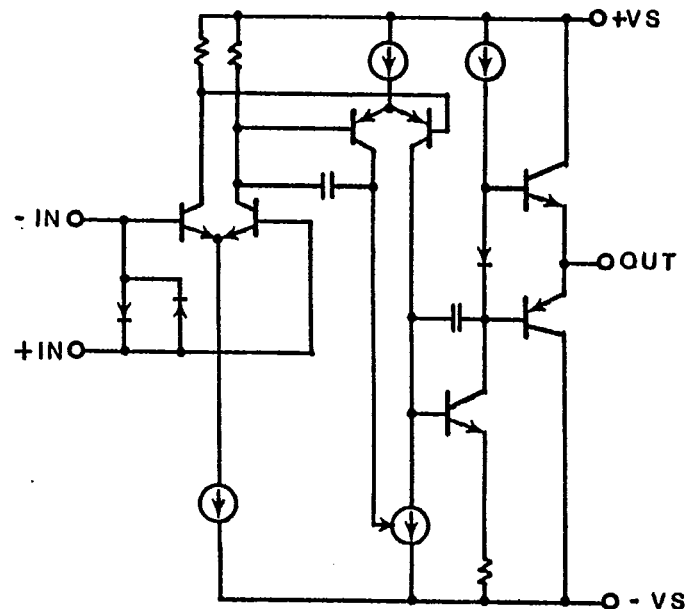

Electrical Characteristics

ABSOLUTE MAXIMUM RATINGS

Supply Voltage (Between +VS and -VS Terminals)	45 Volts
Differential Input Voltage	±0.3 Volts
Common Mode Input Voltage	±V Supply
Power Dissipation	1 Watt
Operating Temperature Range	0°C to +70°C
Storage Temperature Range	-65°C to +150°C
Lead Temperature (Soldering, 10 Seconds)	+300°C

SPECIFICATIONS¹ at ±VS= ±22V; TA=+25°C

	Min	Typ	Max	Units
INPUT				
Offset voltage		±1.0	±5.0	millivolts
Offset voltage drift ²		±10	±20	μV/°C
Bias current		400	1000	nanoamps
Offset current		50	300	nanoamps
Offset current drift ³		0.3	2	nA/°C
Common mode voltage	±18	±20		volts
Common mode rejection	90	100		dB
Noise voltage ⁴		3.5	5	nV/Hz
Noise current ⁵		0.5	1	PA/Hz
OPEN LOOP GAIN AT DC	94	104		dB
DYNAMIC RESPONSE				
Total harmonic distortion		.0002	.0003	%
Slew rate	±15	±20		V/μ Sec
Gain—bandwidth product ⁶	30	45		MHz
Second pole frequency		60		MHz
Phase margin		20		degrees
Settling time to 0.1%		2.4	4	microseconds
OUTPUT				
Voltage—10k Ω load	±19	±20.5		volts
Voltage—600 Ω load	±18	±19		volts
Load current limit	±40	±45		milliamps
Full power band width	110	150		kHz
POWER SUPPLY				
Current		±4.5	±8	milliamps
Device dissipation		216	352	milliwatts
Minimum voltage		±5		volts

Notes: ¹Other than voltage levels, operation at ±VS ±15 volts is not significantly different.
²Specified for the "Operating Temperature Range"
³ibid.
⁴Noise is specified for a bandwidth of 300 Hz to 20 kHz, Rs = 100 ohms.
⁵ibid.
⁶Gain bandwidth product is specified at a closed loop gain of 100X (40dB).

2

Typical Circuits and Applications

The internally compensated MA-332 provides ultra-low distortion, wide dynamic range amplification and drive for a number of applications. Basic connections are:

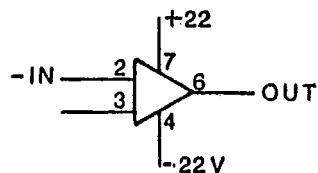

Power supply lines should be bypassed within three inches of the MA-332, to avoid oscillations from on-chip feedback paths. Conventional feedback is used in inverting and non-inverting circuits, as shown here.

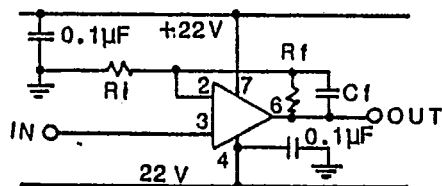
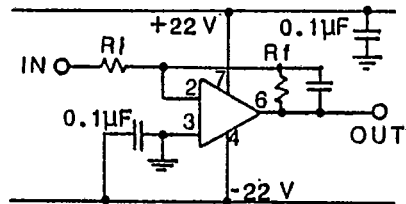

The use of a feedback capacitor, Cf, cancels the input capacitance of the integrated circuit, and the wiring capacitance at the summing junction. Typical values of Cf are 3-10pF.

The low total harmonic distortion is inherent in the MA-332 circuitry, and is not a function of external components, although it could be. Voltage-variable components will alter linearity of the voltage gain. Use components with low voltage coefficients for critical applications.

Good grounding techniques to keep signal, power and load currents from adding to the input voltage, are equally important.

Use a common ground point for all common connections. This eliminates potential difference in the circuit. This is illustrated below in an example dealing with both input and output cables. For example:

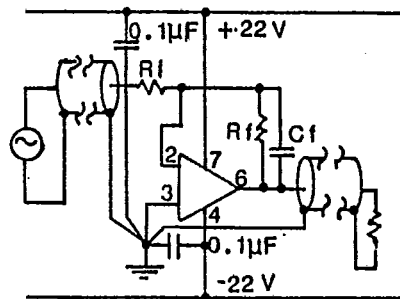

When a true common ground point cannot be used, a heavy ground conductor or ground plane should be used.

Driving output cables can cause oscillation if the length of the cables is long enough to exceed 3nF total capacity. Place a 10 ohm resistor in series with the output cable to eliminate oscillations.

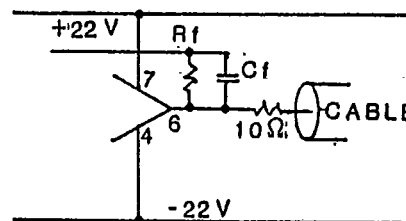

The 3nF load capacitance limit places a maximum cable length restriction of 120' for 25pF/foot cable. The additional resistor eliminates the length restriction, but could cause an error at the load, due to the 10 ohm resistance.

Driving load capacitance requires current defined as follows:

$$I_{CL} = CL \cdot SR$$

SR is the slew rate, CL is the load capacitance and I_{CL} is the load current due to the load capacitance. For a CL = 1nF and SR = 10 V/µS, I_{CL} = 10 mA. If the output is driving a 600 ohm load, current limit is 40 mA, 40-10 = 30 mA is available for the 600 ohm resistive load. This means an upper limit of ±18 Volts swing. If: ±19 Volts is driven into the load, slew rate limiting will occur.

7/1/81

TUCSON, ARIZONA

