

Digital transistors (built-in resistors)

LDTA113ZL T 1

●Features

- 1) The built-in bias resistor allows the configuration of an inverter circuit without connecting any external input resistors (see Equivalent circuit).
- 2) Each bias resistor is a thin-film resistor. Since they are completely insulated, the input can be positively biased. The insulation also eliminates most of the parasitic effects.
- 3) Circuit design is simplified since only the OFF and the ON conditions have to be set.

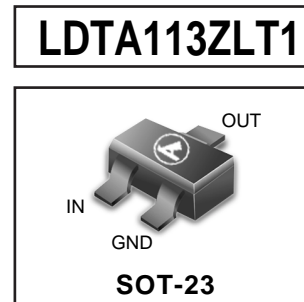

●Structure

PNP digital transistor
(with built in resistors).

Driver Marking LDTA113ZLT1=BA

●Equivalent circuit

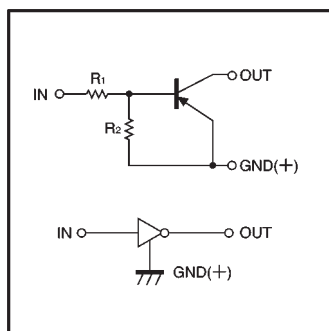

LDTA113ZLT1
●Absolute maximum ratings (Ta=25°C)

Parameter	Symbol	Limits		Unit
Supply voltage	V _{CC}	-50		V
Input voltage	V _{IN}	-5~+10		V
Output current	I _o	-100		mA
	I _{C(Max.)}	-100		
Power dissipation	P _d	225		mW
Junction temperature	T _J	150		°C
Storage temperature	T _{stg}	-55~+150		°C

●Electrical characteristics (Ta=25°C)

Parameter	Symbol	Min.	Typ.	Max.	Unit	Conditions
Input voltage	V _{I(off)}	-	-	-0.3	V	V _{CC} = -5V, I _o = -100μA
	V _{I(on)}	-3	-	-		V _o = -0.3V, I _o = -20mA
Output voltage	V _{O(on)}	-	-	-0.3	V	I _o /I _i = -10mA/-0.5mA
Input current	I _i	-	-	-7.2	mA	V _i =-5V
Output current	I _{O(off)}	-	-	-0.5	μA	V _{CC} = -50V, V _i =0V
DC current gain	G _i	33	-	-	-	V _o =5V, I _o =5mA
Input resistance	R ₁	0.7	1	1.3	kΩ	-
Resistance ratio	R ₂ /R ₁	8	10	12	-	-
Transition frequency	f _r	-	250	-	MHz	V _{CE} = -10V, I _E = -5mA, f=100MHz *

* Transition frequency of the device

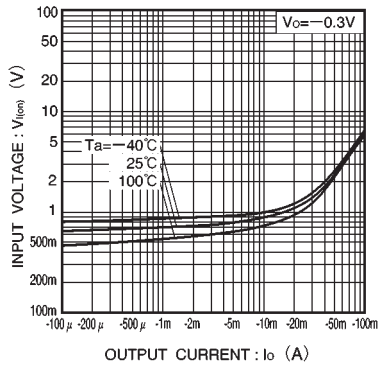
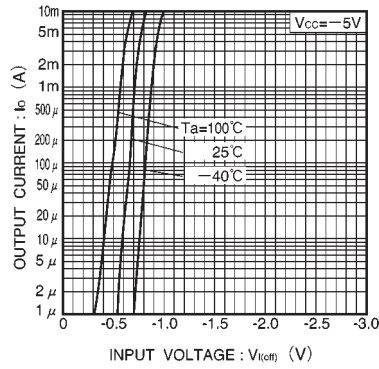
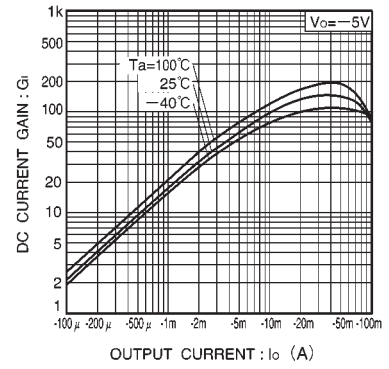
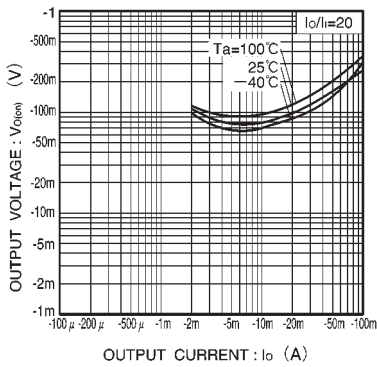
LDTA113ZLT1
● Electrical characteristic curves

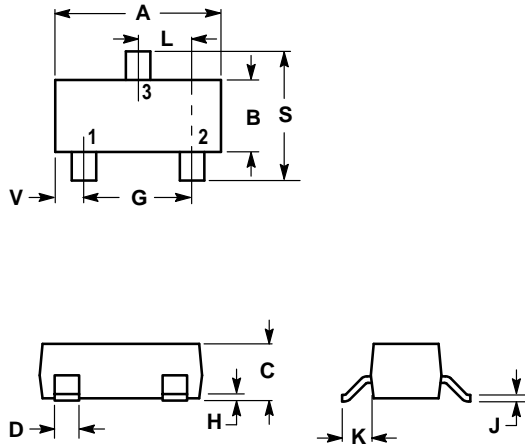
Fig.1 Input voltage vs. output current (ON characteristics)

Fig.2 Output current vs. input voltage (OFF characteristics)

Fig.3 DC current gain vs. output current

Fig.4 Output voltage vs. output current

LDTA113ZLT1
SOT-23

NOTES:

1. DIMENSIONING AND TOLERANCING PER ANSI Y14.5M, 1982.
2. CONTROLLING DIMENSION: INCH.

DIM	INCHES		MILLIMETERS	
	MIN	MAX	MIN	MAX
A	0.1102	0.1197	2.80	3.04
B	0.0472	0.0551	1.20	1.40
C	0.0350	0.0440	0.89	1.11
D	0.0150	0.0200	0.37	0.50
G	0.0701	0.0807	1.78	2.04
H	0.0005	0.0040	0.013	0.100
J	0.0034	0.0070	0.085	0.177
K	0.0140	0.0285	0.35	0.69
L	0.0350	0.0401	0.89	1.02
S	0.0830	0.1039	2.10	2.64
V	0.0177	0.0236	0.45	0.60

- PIN 1. BASE
 2. EMITTER
 3. COLLECTOR

