

## 高速整流ダイオード

### FAST RECOVERY DIODE

## ■外形寸法：Outline Drawings

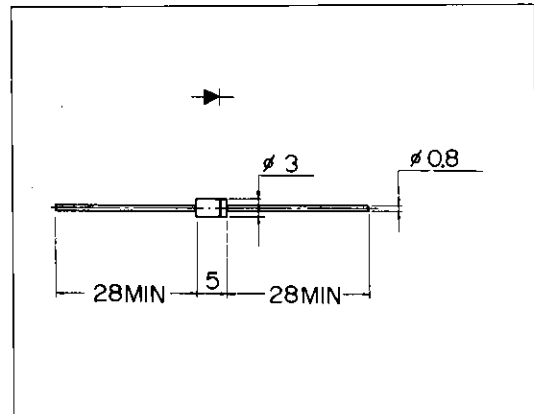

A

## ■特長：Features

- カラーTVダンパー用に最適  
Most suitable for color T.V. damper.
- メサ形のため耐圧が高い  
High voltage by mesa design.
- 高信頼性  
High reliability

## ■用途：Applications

- 高速スイッチング  
High speed switching.

## ■表示：Marking

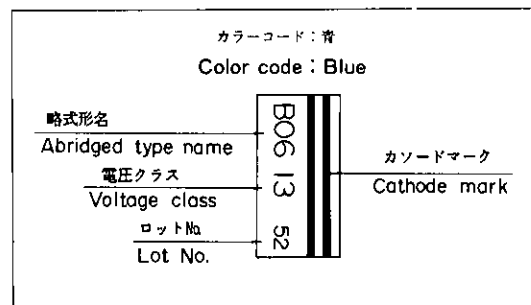

## ■定格と特性：Maximum Ratings and Characteristics

### ●絶対最大定格：Absolute Maximum Ratings

Items	Symbols	Conditions	Ratings		Units
			-13	-15	
ピーク繰り返し逆電圧 Repetitive Peak Reverse Voltage	$V_{RRM}$		1300	1500	V
平均順電流 Average Forward Current	$I_{F(AV)}$	抵抗負荷 Resistive load $T_a = 40^\circ\text{C}$	1.0		A
サージ電流 Surge Current	$I_{FSM}$	正弦波 Sine wave 10ms	50		A
接合温度 Operating Junction Temperature	$T_j$		-40 ~ +150		$^\circ\text{C}$
保存温度 Storage Temperature	$T_{stg}$		-40 ~ +150		$^\circ\text{C}$

### ●電気的特性(特に指定がない限り周囲温度 $T_a = 25^\circ\text{C}$ とする)

Electrical Characteristics ( $T_a = 25^\circ\text{C}$  Unless otherwise specified)

Items	Symbols	Conditions	Max.	Units
順電圧 Forward Voltage Drop	$V_{FM}$	$I_{FM} = 4\text{A}$	1.5	V
逆電流 Reverse Current	$I_{RRM}$	$V_R = V_{RRM}$	10	$\mu\text{A}$
逆回復時間 Reverse Recovery Time	$t_{rr}$	$I_F = 0.1\text{A}, I_R = 0.1\text{A}$	4	$\mu\text{s}$

■特性曲線 : Characteristics

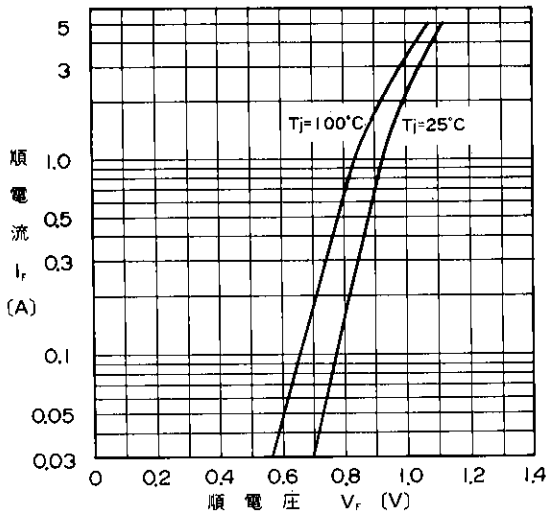

順特性 (代表特性)  
Forward Characteristics

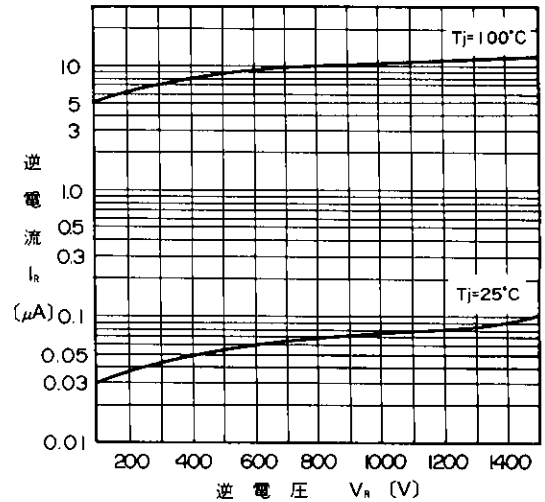

逆特性 (代表特性)  
Reverse Characteristics

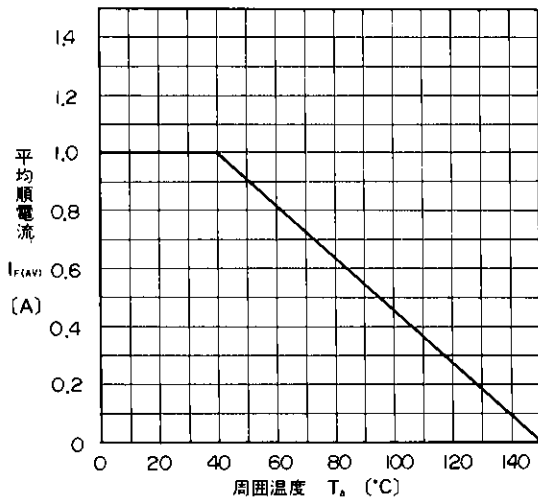

平均順電流—周囲温度特性  
Current Derating ( $I_{F(AV)}-T_a$ )

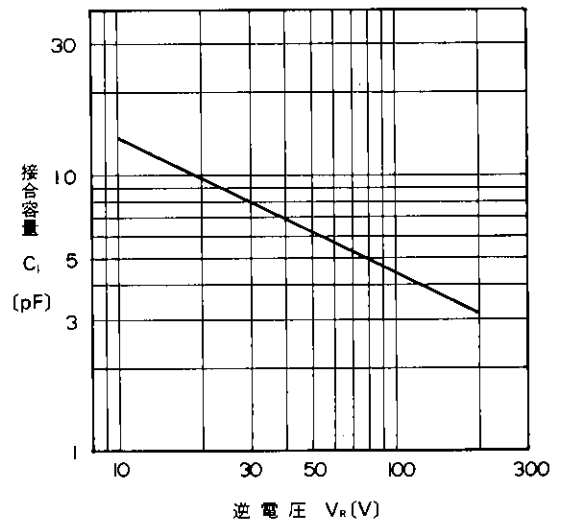

接合容量特性 (代表特性)  
Junction Capacitance Characteristics

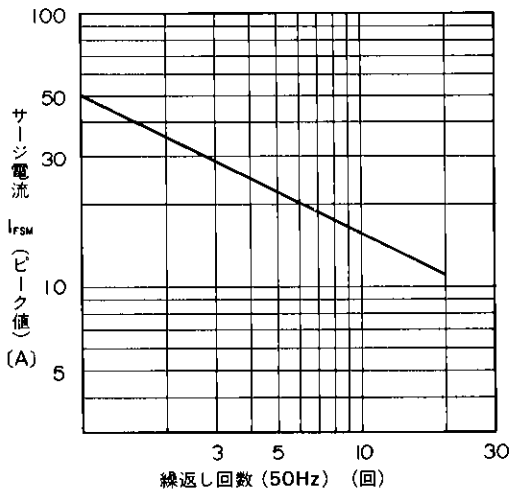

サージ電流耐量  
Surge Capability

For more information, contact:

**Collmer Semiconductor, Inc.**

P.O. Box 702708

Dallas, TX 75370

972-233-1589

972-233-0481 Fax

<http://www.collmer.com>