

FRD Type : EA21FC2-F

OUTLINE DRAWING

FEATURES

- * TO-252AA Case, Surface Mounting Device
- * Packaged in 16mm Tape and Reel
- * Ultra – Fast Recovery
- * Low Forward Voltage drop
- * Low Power Loss
- * High Surge Capability
- * 200 Volts thru 400 Volts Types Available

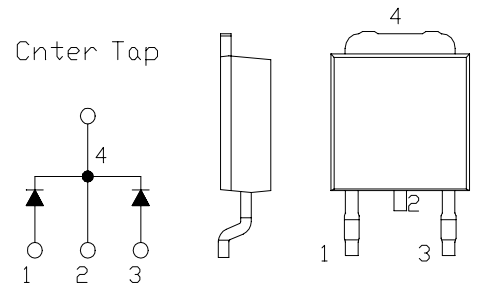

Maximum Ratings

Approx Net Weight:0.30g

Rating		Symbol	EA21FC2-F			Unit
Repetitive Peak Reverse Voltage		V_{RRM}	200			V
Non-repetitiv Peak Reverse Voltage		V_{RSM}	220			
Average Rectified Output Current	P.C.Board mounted *	I_O	1.6	$T_a=25^{\circ}C$	50Hz Full Sine Wave Resistive Load	A
	-		2.0	$T_c=136^{\circ}C$		
RMS Forward Current		$I_{F(RMS)}$	2.22			A
Surge Forward Current		I_{FSM}	30	50Hz Full Sine Wave,1cycle, Non-repetitive		A
Operating JunctionTemperature Range		T_{jw}	- 40 to + 150			$^{\circ}C$
Storage Temperature Range		T_{stg}	- 40 to + 150			$^{\circ}C$

Electrical • Thermal Characteristics

Characteristics		Symbol	Conditions	Min	Typ	Max	Unit
Peak Reverse Current		I_{RM}	$T_j=25^{\circ}C, V_{RM}=V_{RRM}$ per Arm	-	-	10	μA
Peak Forward Voltage		V_{FM}	$T_j=25^{\circ}C, I_{FM}= 1 A$ per Arm	-	-	0.98	V
Reverse Recovery Time		t_{rr}	$I_{FM}= 1 A,$ $-di/dt= 50 A/\mu s, T_a= 25^{\circ}C$	-	-	30	ns
Thermal Resistance	Junction to Ambient	$R_{th(j-a)}$	P.C.Board mounted *	-	-	80	$^{\circ}C/W$
	Junction to Case	$R_{th(j-c)}$	-	-	-	6	$^{\circ}C/W$

* Print Land = 20x20 mm

EA21FC2-F OUTLINE DRAWING (Dimensions in mm)

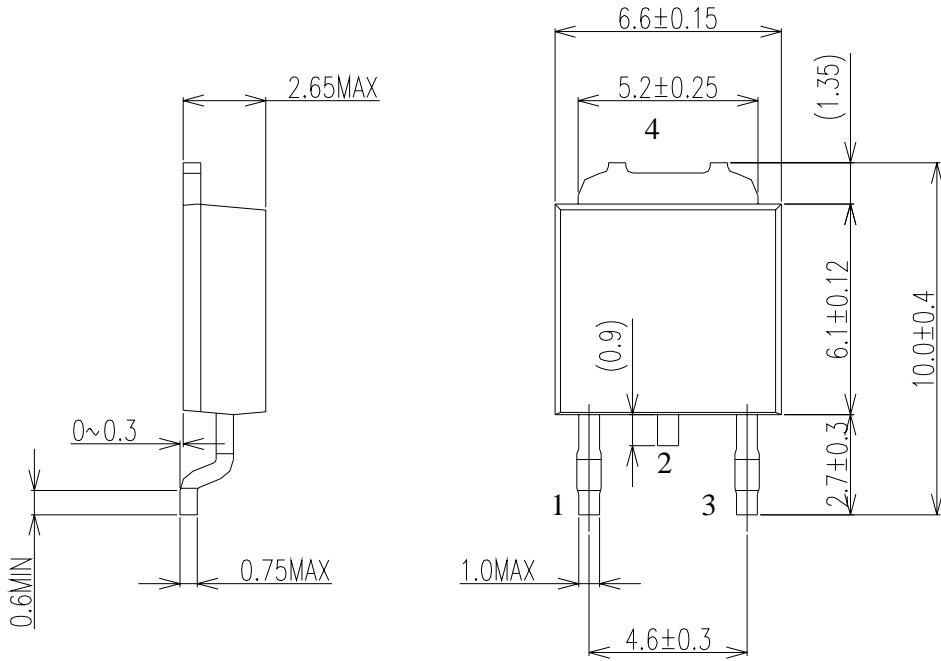

Soldering PAD

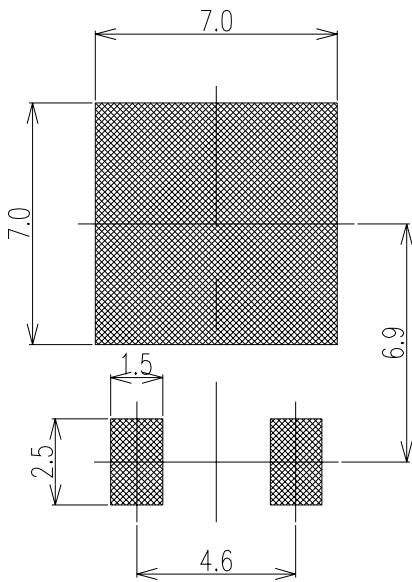

Center Tap

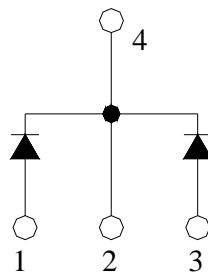

FORWARD CURRENT VS. VOLTAGE

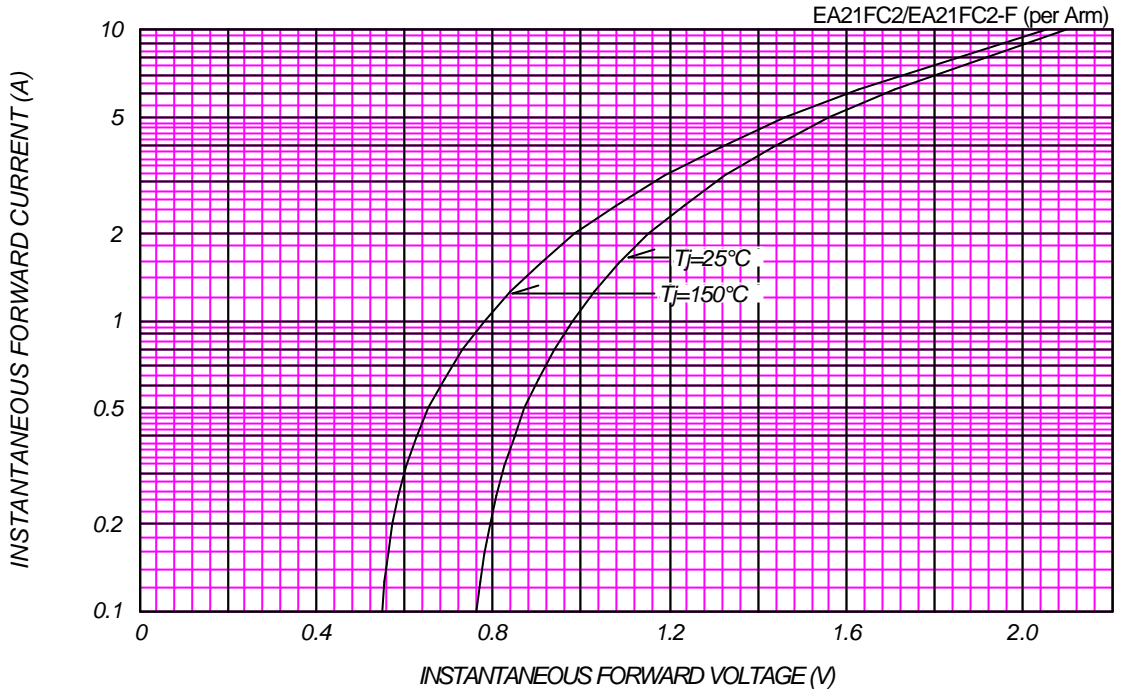

AVERAGE FORWARD POWER DISSIPATION

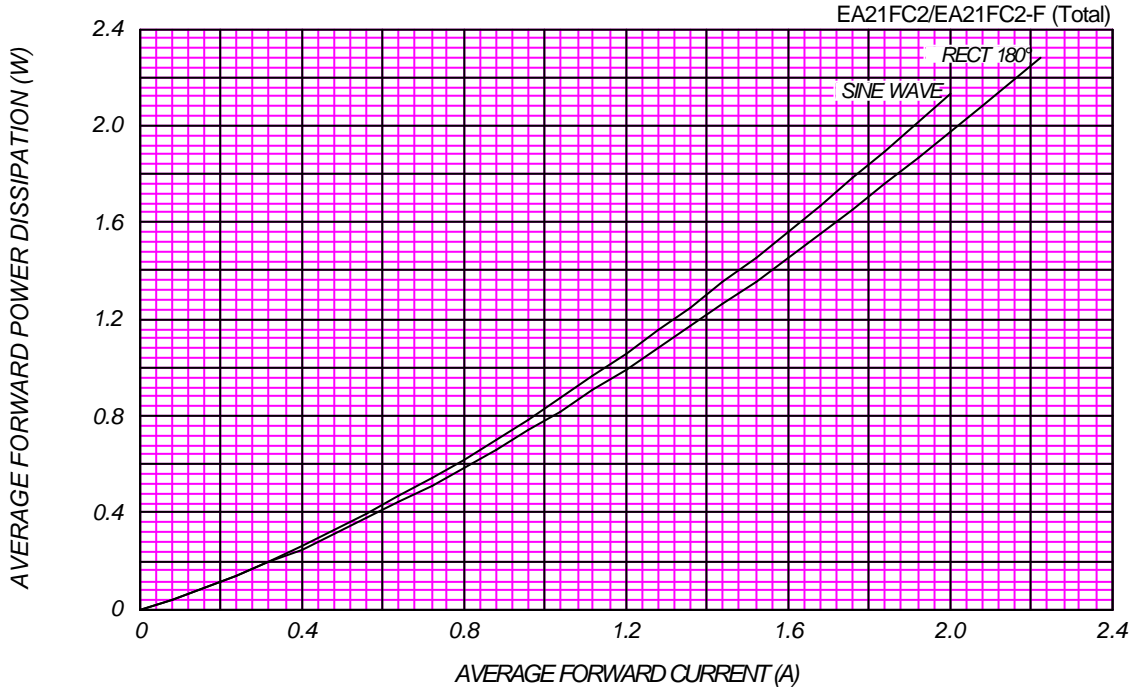



AVERAGE FORWARD CURRENT VS. CASE TEMPERATURE

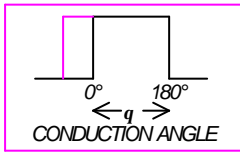
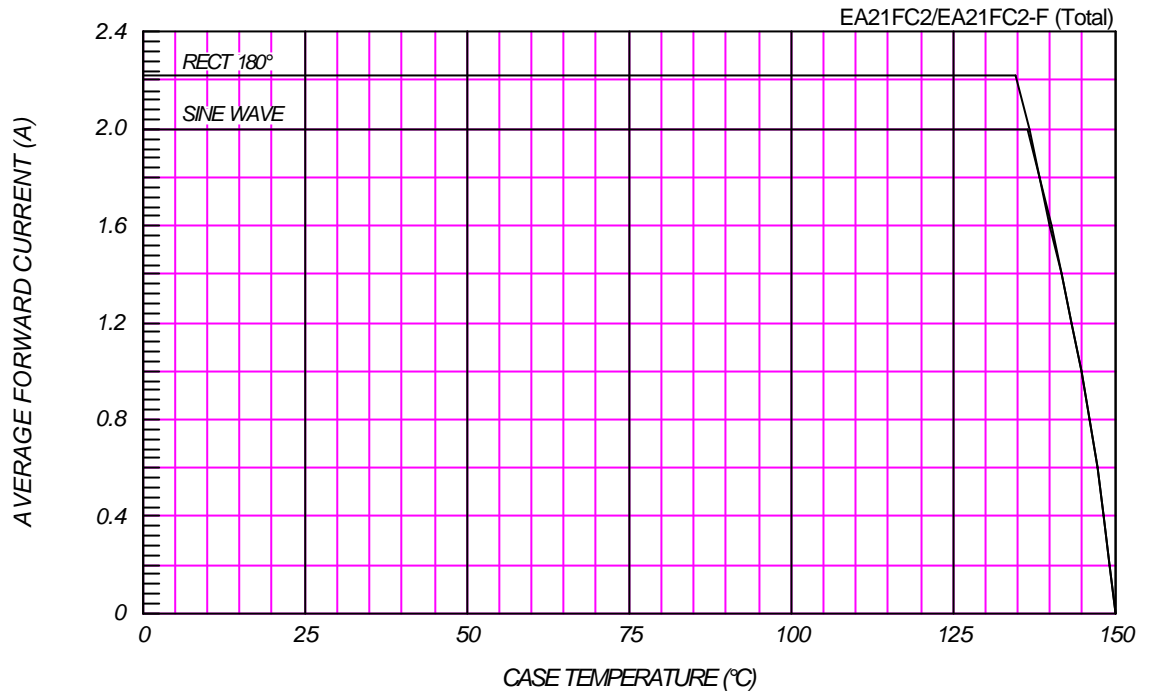

AVERAGE FORWARD CURRENT VS. AMBIENT TEMPERATURE

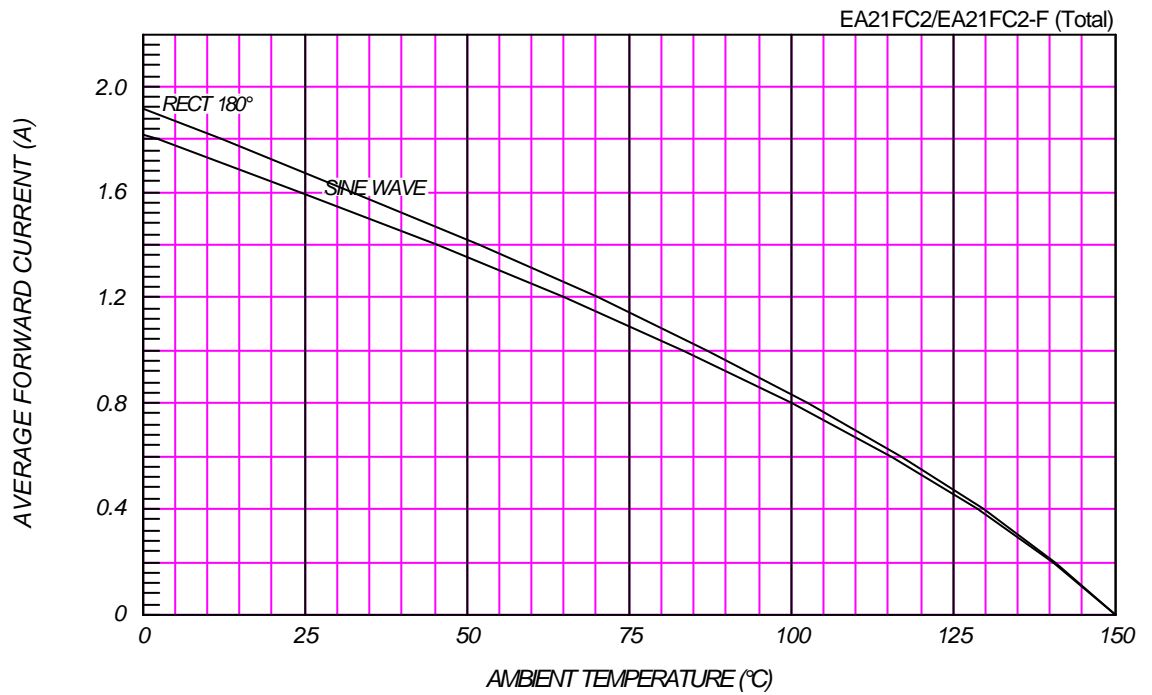

SURGE CURRENT RATINGS

f=50Hz, Sine Wave, Non-Repetitive, No Load

EA21FC2/EA21FC2-F

