



# High-speed Multi-phase PLL Clock Buffer

## Features

- 500 ps max. Total Timing Budget™ (TTB™) window
- 24–200 MHz input/output operation
- Low output-output skew < 200 ps
- 10 + 1 LVTTTL outputs driving 50Ω terminated lines
- Dedicated feedback output
- Phase adjustments in 625/1300 ps steps up to ±10.4 ns
- 3.3V LVTTTL/LVPECL, fault-tolerant, and hot-insertable reference inputs
- Multiply/divide ratios of 1–6, 8, 10, and 12
- Individual output bank disable
- Output high-impedance option for testing purposes
- Integrated phase-locked loop (PLL) with lock indicator
- Low cycle-cycle jitter (<100 ps peak-peak)
- 3.3V operation
- Industrial temperature range: –40°C to +85°C
- 52-pin 1.4-mm TQFP package

## Functional Description

The CY7B9945V high-speed multi-phase PLL clock buffer offers user-selectable control over system clock functions.

This multiple-output clock driver provides the system integrator with functions necessary to optimize the timing of high-performance computer and communication systems.

The device features a guaranteed maximum TTB window specifying all occurrences of output clocks with respect to the input reference clock across variations in output frequency, supply voltage, operating temperature, input edge rate, and process.

Ten configurable outputs each drive terminated transmission lines with impedances as low as 50Ω while delivering minimal and specified output skews at LVTTTL levels. The outputs are arranged in two banks of four and six outputs. These banks allow a divide function of 1 to 12, with phase adjustments in 625-ps–1300-ps increments up to ±10.4 ns. The dedicated feedback output allows divide-by functionality from 1 to 12 and limited phase adjustments. However, if needed, any one of the ten outputs can be connected to the feedback input as well as driving other inputs.

Selectable reference input is a fault-tolerant feature which allows smooth change over to secondary clock source, when the primary clock source is not in operation. The reference inputs and feedback inputs are configurable to accommodate both LVTTTL or Differential (LVPECL) inputs. The completely integrated PLL reduces jitter and simplifies board layout.

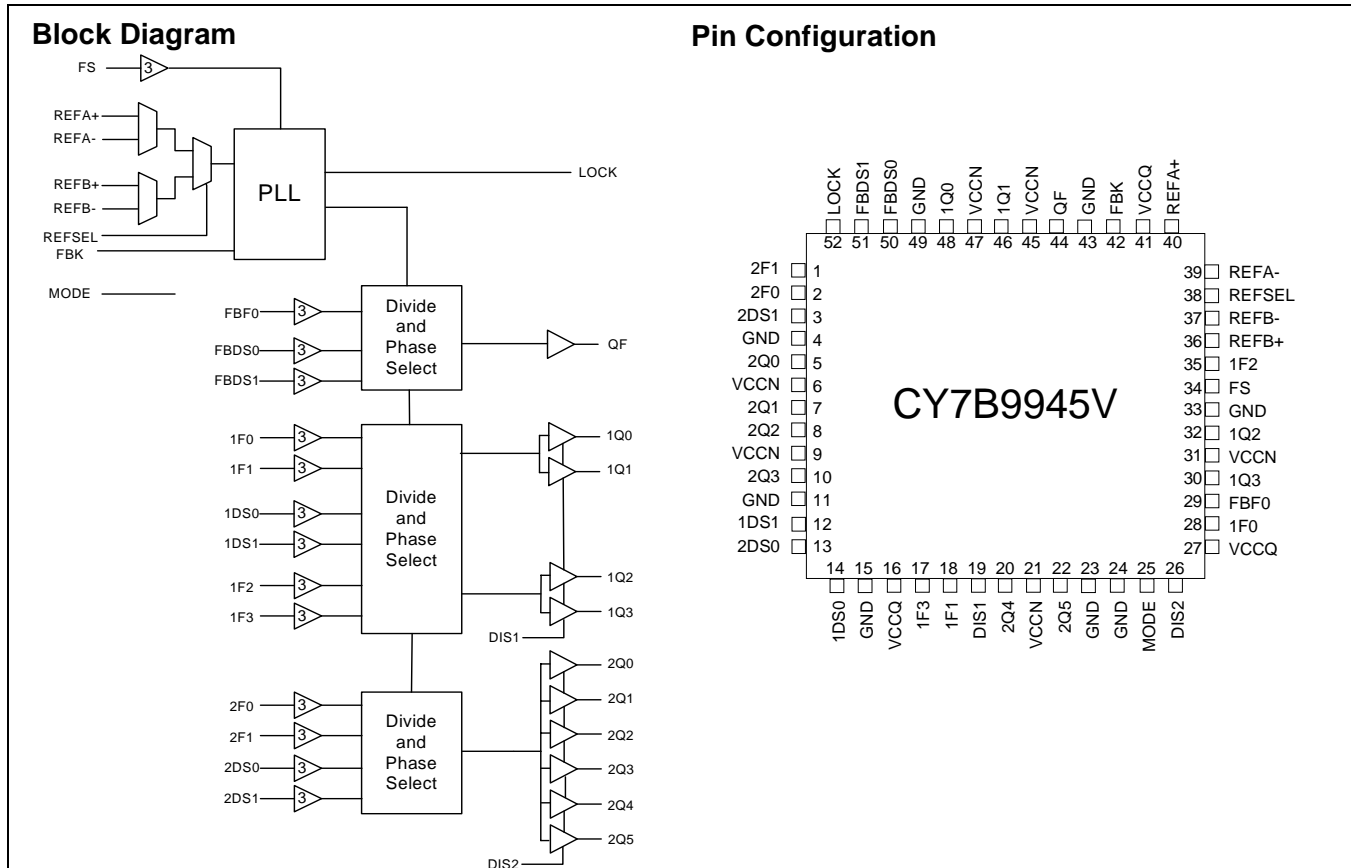

**Pin Definitions**

Pin	Name	I/O	Type	Description
34	FS	Input	Three-level Input	<b>Frequency Select.</b> This input must be set according to the nominal frequency ( $f_{NOM}$ ). See <i>Table 1</i> .
40,39, 36,37	REFA+, REFA- REFB+, REFB-	Input	LVTTTL/ LVDIFF	<b>Reference Inputs.</b> These inputs can operate as differential PECL or single-ended TTL reference inputs to the PLL. When operating as a single-ended LVTTTL input, the complementary input must be left open.
38	REFSEL	Input	LVTTTL	<b>Reference Select Input.</b> The REFSEL input controls how the reference input is configured. When LOW, it will use the REFA pair as the reference input. When HIGH, it will use the REFB pair as the reference input. This input has an internal pull-down.
42	FBK	Input	LVTTTL	<b>Feedback Input Clock.</b> The PLL will operate such that the rising edges of the reference and feedback signals are aligned in phase and frequency. This pin is used to feedback the clock output QF to the phase detector.
28,18, 35,17, 2, 1	1F[0:3], 2F[0:1]	Input	3-level Input	<b>Output Phase Function Select.</b> Each pair determines the phase of the respective bank of outputs. See <i>Table 3</i> .
19,26	DIS[1:2]	Input	LVTTTL	<b>Output Disable.</b> Each input controls the state of the respective output bank. When HIGH, the output bank is disabled to "HOLD-OFF" or "High-Z" state; the disable state is determined by MODE. When LOW, outputs 1Q[0:3] and 2Q[0:5] are enabled. See <i>Table 5</i> .
14,12, 13,3	[1:2]DS[0:1]	Input	3-level Input	<b>Output Divider Function Select.</b> Each pair determines the divider ratio of the respective bank of outputs. See <i>Table 4</i> .
29	FBF0	Input	3-level Input	<b>Feedback Output Phase Function Select.</b> This input determines the phase of the QF output. See <i>Table 3</i> .
50,51	FBDS[0:1]	Input	3-level Input	<b>Feedback Output Divider Function Select.</b> This input determines the divider ratio of the QF output. See <i>Table 4</i> .
48,46, 32,30, 5,7,8,10 , 20,22	1Q[0:3], 2Q[0:5]	Output	LVTTTL	<b>Clock Outputs with Adjustable Phases and <math>f_{NOM}</math> Divide Ratios.</b> The output frequencies and phases are determined by [1:2]DS[0:1], and 1F[0:3] and 2F[0:1], respectively. See <i>Table 3</i> and <i>Table 4</i> .
44	QF	Output	LVTTTL	<b>Feedback Clock Output.</b> This output is intended to be connected to the FBK input. The output frequency and phase are determined by FBDS[0:1] and FBF0, respectively. See <i>Table 3</i> and <i>4</i> .
52	LOCK	Output	LVTTTL	<b>PLL Lock Indicator.</b> When HIGH, this output indicates the internal PLL is locked to the reference signal. When LOW, it indicates that the PLL is attempting to acquire lock
25	MODE	Input	3-level Input	<b>This pin determines the clock outputs' disable state.</b> When this input is HIGH, the clock outputs will disable to high impedance state (High-Z). When this input is LOW, the clock outputs will disable to HOLD-OFF mode. When in MID, the device will enter factory test mode.
6,9,21, 31, 45, 47	VCCN		PWR	<b>Power Supply for the Output Buffers</b>
16,27, 41	VCCQ		PWR	<b>Power Supply for the Internal Circuitry</b>
4,11,15, 23,24, 33,43,4 9	GND		PWR	<b>Device Ground</b>

## Block Diagram Description

The PLL adjusts the phase and the frequency of its output signal to minimize the delay between the reference (REFA/B+, REFA/B-) and the feedback (FB) input signals.

The CY7B9945V has a flexible REF input scheme. These inputs allow the use of either differential LVPECL or single-ended LVTTTL inputs. To configure as single-ended LVTTTL inputs, the complementary pin must be left open (internally pulled to 1.5V), then the other input pin can be used as a LVTTTL input. The REF inputs are also tolerant to hot insertion.

The REF inputs can be changed dynamically. When changing from one reference input to the other reference input of the same frequency, the PLL is optimized to ensure that the clock outputs period will not be less than the calculated system budget ( $t_{MIN} = t_{REF}$  (nominal reference period) -  $t_{CCJ}$  (cycle-cycle jitter) -  $t_{PDEV}$  (max. period deviation)) while reacquiring lock.

The FS control pin setting determines the nominal operational frequency range of the divide by one output ( $f_{NOM}$ ) of the device.  $f_{NOM}$  is directly related to the VCO frequency. The FS setting for the device is shown in *Table 1*. For CY7B9945V, the upper  $f_{NOM}$  range extends from 96 MHz to 200 MHz.

**Table 1. Frequency Range Select**

FS <sup>[1]</sup>	$f_{NOM}$ (MHz)	
	Min.	Max.
LOW	24	52
MID	48	100
HIGH	96	200

## Time Unit Definition

Selectable skew is in discrete increments of time unit ( $t_U$ ). The value of a  $t_U$  is determined by the FS setting and the maximum nominal output frequency. The equation to be used to determine the  $t_U$  value is as follows:

$$t_U = 1/(f_{NOM} * N)$$

N is a multiplication factor which is determined by the FS setting.  $f_{NOM}$  is nominal frequency of the device. N is defined in *Table 2*.

**Table 2. N Factor Determination**

FS	CY7B9945V	
	N	$f_{NOM}$ (MHz) at which $t_U = 1.0$ ns
LOW	32	31.25
MID	16	62.5
HIGH	8	125

## Divide and Phase Select Matrix

The Divide Select Matrix is comprised of three independent banks: two banks of clock outputs and one bank for feedback. The Phase Select Matrix, on the other hand, enables independent phase adjustments on 1Q[0:1], 1Q[2:3] and 2Q[0:5]. The frequency of 1Q[0:3] is controlled by 1DS[0:1] while the frequency of 2Q[0:5] is controlled by 2DS[0:1]. The

### Notes:

- The level to be set on FS is determined by the "nominal" operating frequency ( $f_{NOM}$ ) of the VCO and Phase Generator.  $f_{NOM}$  always appears on an output when the output is operating in the undivided mode. The REF and FB are at  $f_{NOM}$  when the output connected to FB is undivided.
- BK1Q denotes following the skew setting of indicated Bank1 outputs.

phase of 1Q[0:1] is controlled by 1F[0:1], that of 1Q[2:3] is controlled by 1F[2:3] and that of 2Q[0:5] is controlled by 2F[0:1].

The high-fanout feedback output buffer (QF) may connect to the feedback input (FBK). This feedback output also has one phase function select input (FBF0) and two divider function selects FBDS[0:1].

The phase capabilities that are chosen by the phase function select pins are shown in *Table 3*. The divide capabilities for each bank are shown in *Table 4*.

**Table 3. Output Phase Select**

Control Signal		Output Phase Function			
1F1	1F0	1Q[0:1]			
1F3	1F2		1Q[2:3]		
2F1	2F0			2Q[0:5]	
	FBF0				QF
LOW	LOW	-4 $t_U$	-4 $t_U$	-8 $t_U$	-4 $t_U$
LOW	MID	-3 $t_U$	-3 $t_U$	-7 $t_U$	N/A
LOW	HIGH	-2 $t_U$	-2 $t_U$	-6 $t_U$	N/A
MID	LOW	-1 $t_U$	-1 $t_U$	BK1Q[0:1] <sup>[2]</sup>	N/A
MID	MID	0 $t_U$	0 $t_U$	0 $t_U$	0 $t_U$
MID	HIGH	+1 $t_U$	+1 $t_U$	BK1Q[2:3] <sup>[2]</sup>	N/A
HIGH	LOW	+2 $t_U$	+2 $t_U$	+6 $t_U$	N/A
HIGH	MID	+3 $t_U$	+3 $t_U$	+7 $t_U$	N/A
HIGH	HIGH	+4 $t_U$	+4 $t_U$	+8 $t_U$	+4 $t_U$

**Table 4. Output Divider Select**

Control Signal		Output Divider Function		
[1:2]DS1 and FBDS1	[1:2]DS0 and FBDS0	Bank1	Bank2	Feedback
LOW	LOW	/ 1	/ 1	/ 1
LOW	MID	/ 2	/ 2	/ 2
LOW	HIGH	/ 3	/ 3	/ 3
MID	LOW	/ 4	/ 4	/ 4
MID	MID	/ 5	/ 5	/ 5
MID	HIGH	/ 6	/ 6	/ 6
HIGH	LOW	/ 8	/ 8	/ 8
HIGH	MID	/ 10	/ 10	/ 10
HIGH	HIGH	/ 12	/ 12	/ 12

*Figure 1* illustrates the timing relationship of programmable skew outputs. All times are measured with respect to REF with the output used for feedback programmed with 0 $t_U$  skew. The PLL naturally aligns the rising edge of the FB input and REF input. If the output used for feedback is programmed to another skew position, then the whole  $t_U$  matrix will shift with respect to REF. For example, if the output used for feedback is programmed to shift -4 $t_U$ , then the whole matrix is shifted forward in time by 4 $t_U$ . Thus an output programmed with 4 $t_U$  of skew will effectively be skewed 8 $t_U$  with respect to REF.

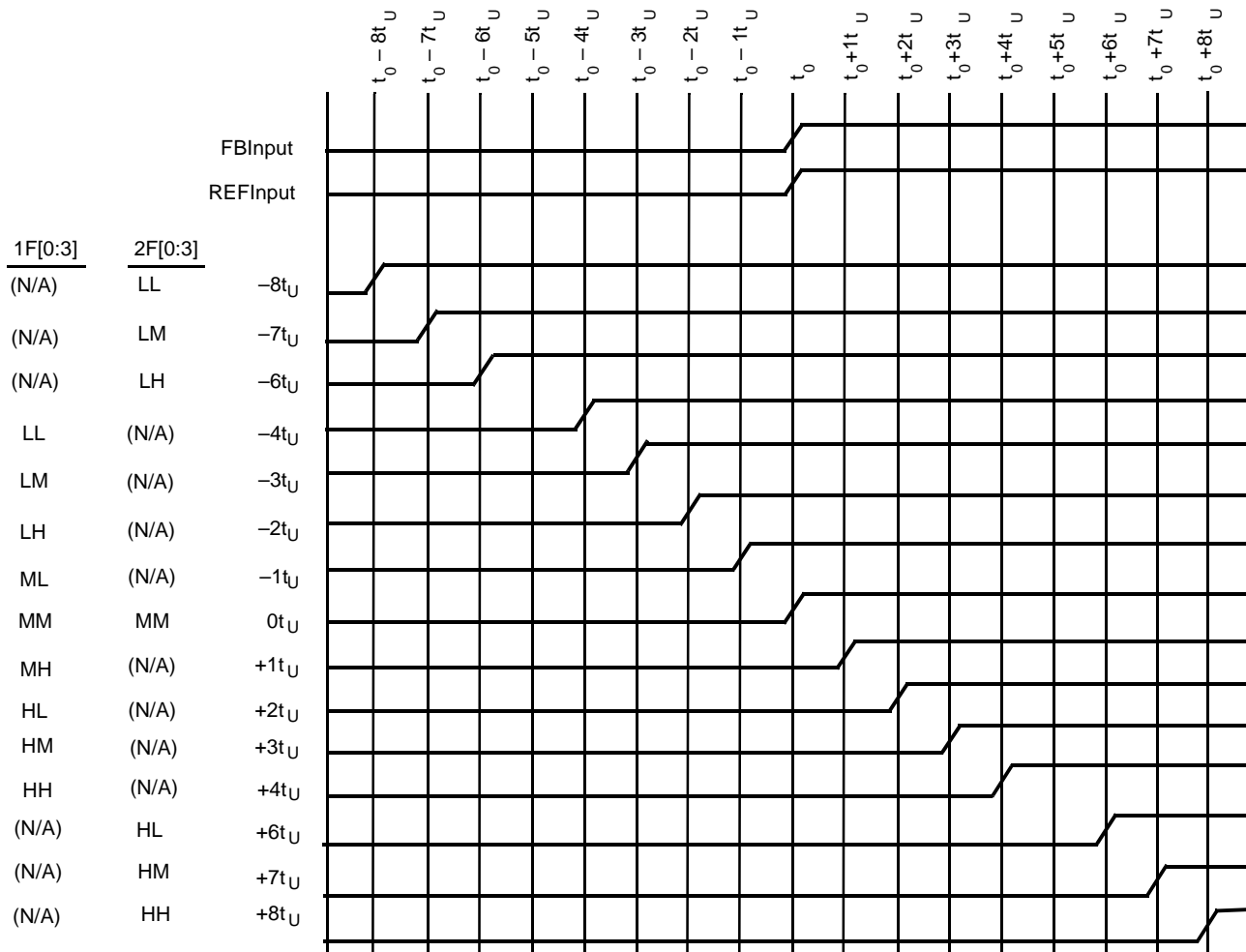

Figure 1. Typical Outputs with FB Connected to a Zero-Skew Output<sup>[3]</sup>

### Output Disable Description

The output of each output bank can be independently put into a HOLD-OFF or high-impedance state. The combination of the MODE and DIS[1:2] inputs determines the clock outputs' state for each bank. When the DIS[1:2] is LOW, the outputs of the corresponding banks will be enabled. When DIS[1:2] is HIGH, the outputs for that bank will be disabled to a high-impedance (HI-Z) or HOLD-OFF state. *Table 5* defines the disabled outputs functions.

The HOLD-OFF state is intended to be a power saving feature. An output bank is disabled to the HOLD-OFF state in a maximum of six output clock cycles from the time when the disable input is HIGH. When disabled to the HOLD-OFF state,

outputs are driven to a logic LOW state on their falling edges. This ensures the output clocks are stopped without a glitch. When a bank of outputs is disabled to HI-Z state, the respective bank of outputs will go HI-Z immediately.

Table 5. DIS[1:2] Functionality

MODE	DIS[1:2]	1Q[0:3], 2Q[0:5]
HIGH/LOW	LOW	ENABLED
HIGH	HIGH	HI-Z
LOW	HIGH	HOLD-OFF
MID	X	FACTORY TEST

**Note:**

3. FB connected to an output selected for "Zero" skew (i.e., FBF0 = MID or XF[1:0] = MID).

### Lock Detect Output Description

The LOCK detect output indicates the lock condition of the integrated PLL. Lock detection is accomplished by comparing the phase difference between the reference and feedback inputs. Phase error is declared when the phase difference between the two inputs is greater than the specified device propagation delay limit  $t_{PD}$ .

When in the locked state, after four or more consecutive feedback clock cycles with phase-errors, the LOCK output will be forced LOW to indicate out-of-lock state.

When in the out-of-lock state, 32 consecutive phase-errorless feedback clock cycles are required to allow the LOCK output to indicate lock condition (LOCK = HIGH).

If the feedback clock is removed after LOCK has gone HIGH, a "Watchdog" circuit is implemented to indicate the out-of-lock condition after a time-out period by deasserting LOCK LOW. This time out period is based upon a divided down reference clock.

This assumes that there is activity on the selected REF input. If there is no activity on the selected REF input then the LOCK detect pin may not accurately reflect the state of the internal PLL.

### Factory Test Mode Description

The device will enter factory test mode when the MODE is driven to MID. In factory test mode, the device will operate with its internal PLL disconnected; input level supplied to the reference input will be used in place of the PLL output. In TEST mode the FB input must be tied LOW. All functions of the device are still operational in factory test mode except the internal PLL and output bank disables. The MODE input is designed to be a static input. Dynamically toggling this input from LOW to HIGH may temporarily cause the device to go into factory test mode (when passing through the MID state).

When in the test mode, the device can be reset to a deterministic state by driving the DIS2 input HIGH. Doing so will cause all outputs to disable and after the selected reference clock pin has five positive transitions, all internal finite state machines (FSM) to be set a deterministic state. The states will depend

on the configurations of the divide, skew and frequency selection. All clock outputs will stay in High-Z mode and all FSMs will stay in the deterministic state until DIS2 is deasserted, which will cause the device to reenter factory test mode.

### Safe Operating Zone

Figure 2 illustrates the operating condition at which the device does not exceed its allowable maximum junction temperature of 150°C. Figure 2 shows the maximum number of outputs that can operate at 185 MHz (with 25-pF load and no air flow) or 200 MHz (with 10-pF load and no air flow) at various ambient temperatures. At the limit line, all other outputs are configured to divide-by-two (i.e., operating at 92.5 MHz) or lower frequencies. The device will operate below maximum allowable junction temperature of 150°C when its configuration (with the specified constraints) falls within the shaded region (safe operating zone). Figure 2 shows that at 85°C, the maximum number of outputs that can operate at 200 MHz is 6.

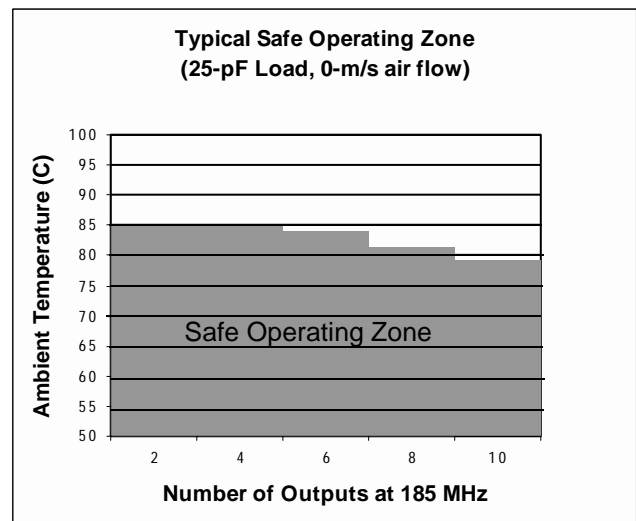

Figure 2. Typical Safe Operating Zone



**Absolute Maximum Conditions**

(Above which the useful life may be impaired. For user guidelines, not tested.)

Storage Temperature ..... -40°C to +125°C  
 Ambient Temperature  
 with Power Applied ..... -40°C to +125°C  
 Supply Voltage to Ground Potential ..... -0.5V to +4.6V  
 DC Input Voltage ..... -0.3V to  $V_{CC}+0.5V$

Output Current into Outputs (LOW) ..... 40 mA  
 Static Discharge Voltage ..... > 1100V  
 (per MIL-STD-883, Method 3015)  
 Latch-up Current ..... > ± 200 mA  
**Operating Range**

Range	Ambient Temperature	$V_{CC}$
Commercial	0°C to +70°C	3.3V ±10%
Industrial	-40°C to +85°C	3.3V ±10%

**Electrical Characteristics** Over the Operating Range

Parameter	Description	Test Conditions	Min.	Max.	Unit	
<b>LVTTL-compatible Output Pins (1Q[0:3],2Q[0:5])</b>						
$V_{OH}$	LVTTL HIGH Voltage	(QF, 1Q[0:3], 2Q[0:5])	$V_{CC} = \text{Min.}, I_{OH} = -30 \text{ mA}$	2.4	-	V
		LOCK	$I_{OH} = -2 \text{ mA}, V_{CC} = \text{Min.}$	2.4	-	V
$V_{OL}$	LVTTL LOW Voltage	(QF, 1Q[0:3], 2Q[0:5])	$V_{CC} = \text{Min.}, I_{OL} = 30 \text{ mA}$	-	0.5	V
		LOCK	$I_{OL} = 2 \text{ mA}, V_{CC} = \text{Min.}$	-	0.5	V
$I_{OZ}$	High-impedance State Leakage Current		-100	100	μA	
<b>LVTTL-compatible Input Pins (FBK, REF±, DIS[1:2],REFSEL)</b>						
$V_{IH}$	LVTTL Input HIGH	$\text{Min.} \leq V_{CC} \leq \text{Max.}$	2.0	$V_{CC} + 0.3$	V	
$V_{IL}$	LVTTL Input LOW	$\text{Min.} \leq V_{CC} \leq \text{Max.}$	-0.3	0.8	V	
$I_I$	LVTTL $V_{IN} > V_{CC}$	$V_{CC} = \text{GND}, V_{IN} = 3.63V$	-	100	μA	
$I_{IH}$	LVTTL Input HIGH Current	$V_{CC} = \text{Max.}, V_{IN} = V_{CC}$	-	500	μA	
$I_{IL}$	LVTTL Input LOW Current	$V_{CC} = \text{Max.}, V_{IN} = \text{GND}$	-500	-	μA	
<b>Three-level Input Pins (FS[0:2], 1F[0:3], 2F[0:1], [1:2]DS[0:1], FBFO, FBDS[0:1],MODE)</b>						
$V_{IHH}$	Three-level Input HIGH <sup>[4]</sup>	$\text{Min.} \leq V_{CC} \leq \text{Max.}$	$0.87 * V_{CC}$	-	V	
$V_{IMM}$	Three-level Input MID <sup>[4]</sup>	$\text{Min.} \leq V_{CC} \leq \text{Max.}$	$0.47 * V_{CC}$	$0.53 * V_{CC}$	V	
$V_{ILL}$	Three-level Input LOW <sup>[4]</sup>	$\text{Min.} \leq V_{CC} \leq \text{Max.}$	-	$0.13 * V_{CC}$	V	
$I_{IHH}$	Three-level Input HIGH Current	FS[0:2],IF[0:3],FBDS[0:1]	$V_{IN} = V_{CC}$	-	200	μA
		2F[0:1],[1:2]DS[0:1],FBFO		-	400	μA
$I_{IMM}$	Three-level Input MID Current	FS[0:2],IF[0:3],FBDS[0:1]	$V_{IN} = V_{CC}/2$	-50	50	μA
		2F[0:1],[1:2]DS[0:1],FBFO		-100	100	μA
$I_{ILL}$	Three-level Input LOW Current	FS[0:2],IF[0:3],FBDS[0:1]	$V_{IN} = \text{GND}$	-200	-	μA
		2F[0:1],[1:2]DS[0:1],FBFO		-400	-	μA
<b>LVDIFF Input Pins (REF[A:B]±)</b>						
$V_{DIFF}$	Input Differential Voltage		400	$V_{CC}$	mV	
$V_{IHHP}$	Highest Input HIGH Voltage		1.0	$V_{CC}$	V	
$V_{ILLP}$	Lowest Input LOW Voltage		GND	$V_{CC} - 0.4$	V	
$V_{COM}$	Common Mode Range (Crossing Voltage)		0.8	$V_{CC} - 0.2$	V	
<b>Operating Current</b>						
$I_{CCI}$	Internal Operating Current	CY7B9945V	$V_{CC} = \text{Max.}, f_{MAX}$ <sup>[5]</sup>	-	250	mA
$I_{CCN}$	Output Current Dissipation/Pair <sup>[6]</sup>	CY7B9945V	$V_{CC} = \text{Max.}, C_{LOAD} = 25 \text{ pF}, R_{LOAD} = 50\Omega \text{ at } V_{CC}/2, f_{MAX}$	-	40	mA

**Note:**

- These inputs are normally wired to  $V_{CC}$ , GND, or left unconnected (actual threshold voltages vary as a percentage of  $V_{CC}$ ). Internal termination resistors hold the unconnected inputs at  $V_{CC}/2$ . If these inputs are switched, the function and timing of the outputs may glitch and the PLL may require an additional  $t_{LOCK}$  time before all data sheet limits are achieved.
- $I_{CCI}$  measurement is performed with Bank1 and FB Bank configured to run at maximum frequency ( $f_{NOM} = 200 \text{ MHz}$ ) and the other output bank to run at half the maximum frequency. FS is asserted to the HIGH state.
- This is dependent upon frequency and number of outputs of a bank being loaded. The value indicates maximum  $I_{CCN}$  at maximum frequency and maximum load of 25 pF terminated to 50Ω at  $V_{CC}/2$ .

## Capacitance

Parameter	Description	Test Conditions	Min.	Max.	Unit
C <sub>IN</sub>	Input Capacitance	T <sub>A</sub> = 25°C, f = 1 MHz, V <sub>CC</sub> = 3.3V	–	5	pF

## Switching Characteristics Over the Operating Range [7, 8, 9, 10, 11]

Parameter	Description	CY7B9945V-2		CY7B9945V-5		Unit
		Min.	Max.	Min.	Max.	
f <sub>in</sub>	Clock Input Frequency	24	200	24	200	MHz
f <sub>out</sub>	Clock Output Frequency	24	200	24	200	MHz
t <sub>SKEWPR</sub>	Matched-Pair Skew <sup>[12, 13]</sup> , 1Q[0:1], 1Q[2:3], 2Q[0:1], 2Q[2:3], 2Q[4:5]	–	200	–	200	ps
t <sub>SKEWBNK</sub>	Intrabank Skew <sup>[12, 13]</sup>	–	250	–	250	ps
t <sub>SKEW0</sub>	Output-Output Skew (same frequency and phase, rise to rise, fall to fall) <sup>[12, 13]</sup>	–	250	–	550	ps
t <sub>SKEW1</sub>	Output-Output Skew (same frequency and phase, other banks at different frequency, rise to rise, fall to fall) <sup>[12, 13]</sup>	–	250	–	650	ps
t <sub>SKEW2</sub>	Output-Output Skew (all output configurations outside of t <sub>SKEW0</sub> and t <sub>SKEW1</sub> ) <sup>[12, 13]</sup>	–	500	–	800	ps
t <sub>CCJ1-3</sub>	Cycle-to-Cycle Jitter (divide by 1 output frequency, FB = divide by 1, 2, 3)	–	150	–	150	ps Peak-Peak
t <sub>CCJ4-12</sub>	Cycle-to-Cycle Jitter (divide by 1 output frequency, FB = divide by 4, 5, 6, 8, 10, 12)	–	100	–	100	ps Peak-Peak
t <sub>PD</sub>	Propagation Delay, REF to FB Rise	–250	250	–500	500	ps
TTB	Total Timing Budget window (same frequency and phase) <sup>[14, 15]</sup>	–	500	–	700	ps
t <sub>PDELTA</sub>	Propagation Delay difference between two devices <sup>[16]</sup>	–	200	–	200	ps
t <sub>REFpwh</sub>	REF input (Pulse Width HIGH) <sup>[5]</sup>	2.0	–	2.0	–	ns
t <sub>REFpwl</sub>	REF input (Pulse Width LOW) <sup>[5]</sup>	2.0	–	2.0	–	ns
t <sub>r</sub> /t <sub>f</sub>	Output Rise/Fall Time <sup>[17]</sup>	0.15	2.0	0.15	2.0	ns
t <sub>LOCK</sub>	PLL Lock Time From Power-Up	–	10	–	10	ms
t <sub>RELOCK1</sub>	PLL Relock Time (from same frequency, different phase) with Stable Power Supply	–	500	–	500	μs
t <sub>RELOCK2</sub>	PLL Re-Lock Time (from different frequency, different phase) with Stable Power Supply <sup>[18]</sup>	–	1000	–	1000	μs
t <sub>ODCV</sub>	Output duty cycle deviation from 50% <sup>[11]</sup>	–1.0	1.0	–1.0	1.0	ns
t <sub>PWH</sub>	Output HIGH time deviation from 50% <sup>[19]</sup>	–	1.5	–	1.5	ns
t <sub>PWL</sub>	Output LOW time deviation from 50% <sup>[19]</sup>	–	2.0	–	2.0	ns
t <sub>PDEV</sub>	Period deviation when changing from reference to reference <sup>[20]</sup>	–	0.025	–	0.025	UI
t <sub>OAZ</sub>	DIS[1:2] HIGH to output high-impedance from ACTIVE <sup>[12, 21]</sup>	1.0	10	1.0	10	ns
t <sub>OZA</sub>	DIS[1:2] LOW to output ACTIVE from output is high-impedance <sup>[21, 22]</sup>	0.5	14	0.5	14	ns

### Notes:

7. This is for non-three-level inputs.
8. Assumes 25 pF Max. Load Capacitance up to 185 MHz. At 200 MHz the max. load is 10 pF.
9. Both outputs of pair must be terminated, even if only one is being used.
10. Each package must be properly decoupled.
11. AC parameters are measured at 1.5V, unless otherwise indicated.
12. Test Load C<sub>L</sub> = 25 pF, terminated to V<sub>CC</sub>/2 with 50Ω up to 185 MHz and 10-pF load to 200 MHz.
13. SKEW is defined as the time between the earliest and the latest output transition among all outputs for which the same phase delay has been selected when all outputs are loaded with 25 pF and properly terminated up to 185 MHz. At 200 MHz the max load is 10 pF.
14. Tested initially and after any design or process changes that may affect these parameters.
15. TTB is the window between the earliest and the latest output clocks with respect to the input reference clock across variations in output frequency, supply voltage, operating temperature, input clock edge rate, and process. The measurements are taken with the AC test load specified and include output-output skew, cycle-cycle jitter, and dynamic phase error. TTB will be equal to or smaller than the maximum specified value at a given output frequency.
16. Guaranteed by statistical correlation. Tested initially and after any design or process changes that may affect these parameters.
17. Rise and fall times are measured between 2.0V and 0.8V.
18. f<sub>NOM</sub> must be within the frequency range defined by the same FS state.
19. t<sub>PWH</sub> is measured at 2.0V. t<sub>PWL</sub> is measured at 0.8V.



AC Test Loads and Waveforms<sup>[23]</sup>

For LOCK output only	For all other outputs
R1 = 910 Ω	R1 = 100 Ω
R2 = 910 Ω	R2 = 100 Ω
C <sub>L</sub> < 30 pF	C <sub>L</sub> < 25 pF to 185 MHz or 10 pF at 200 MHz

(Includes fixture and probe capacitance)

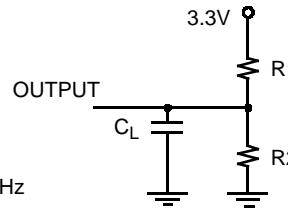

(a) LVTTTL AC Test Load

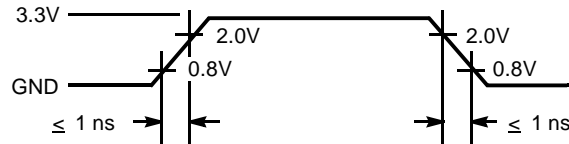

(b) TTL Input Test Waveform

AC Timing Diagram

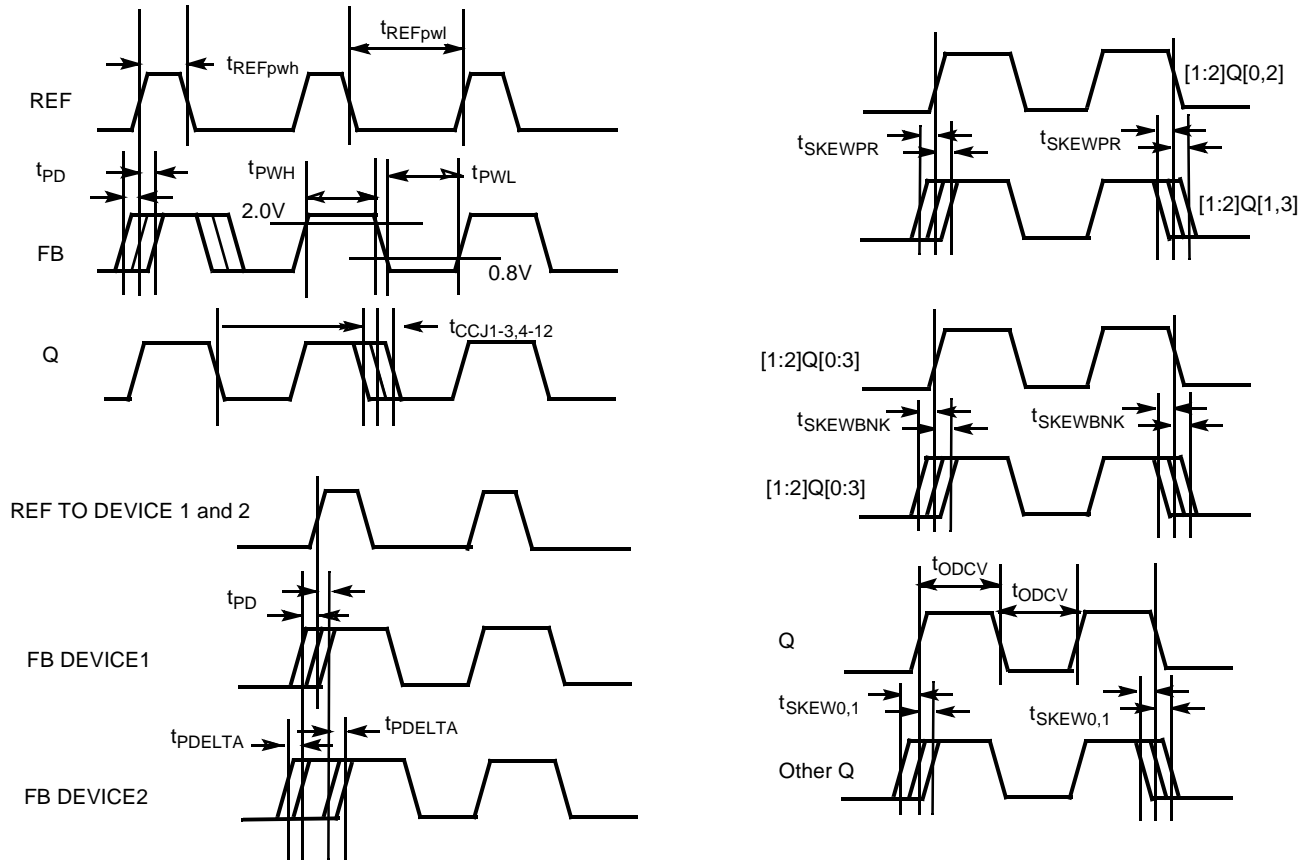

Notes:

- 20. UI = unit interval. Examples: 1 UI is a full period. 0.1UI is 10% of period.
- 21. Measured at 0.5V deviation from starting voltage.
- 22. For t<sub>OZA</sub> minimum, C<sub>L</sub> = 0 pF. For t<sub>OZA</sub> maximum, C<sub>L</sub> = 25 pF to 185 MHz or 10 pF to 200 MHz.
- 23. These figures are for illustration purposes only. The actual ATE loads may vary.



**Ordering Information**

Propagation Delay (ps)	Max. Speed (MHz)	Ordering Code	Package Name	Package Type	Operating Range
250	200	CY7B9945V-2AC	A52	52-lead Thin Quad Flat Pack	Commercial
500	200	CY7B9945V-5AC	A52	52-lead Thin Quad Flat Pack	Commercial
250	200	CY7B9945V-2AI	A52	52-lead Thin Quad Flat Pack	Industrial
500	200	CY7B9945V-5AI	A52	52-lead Thin Quad Flat Pack	Industrial

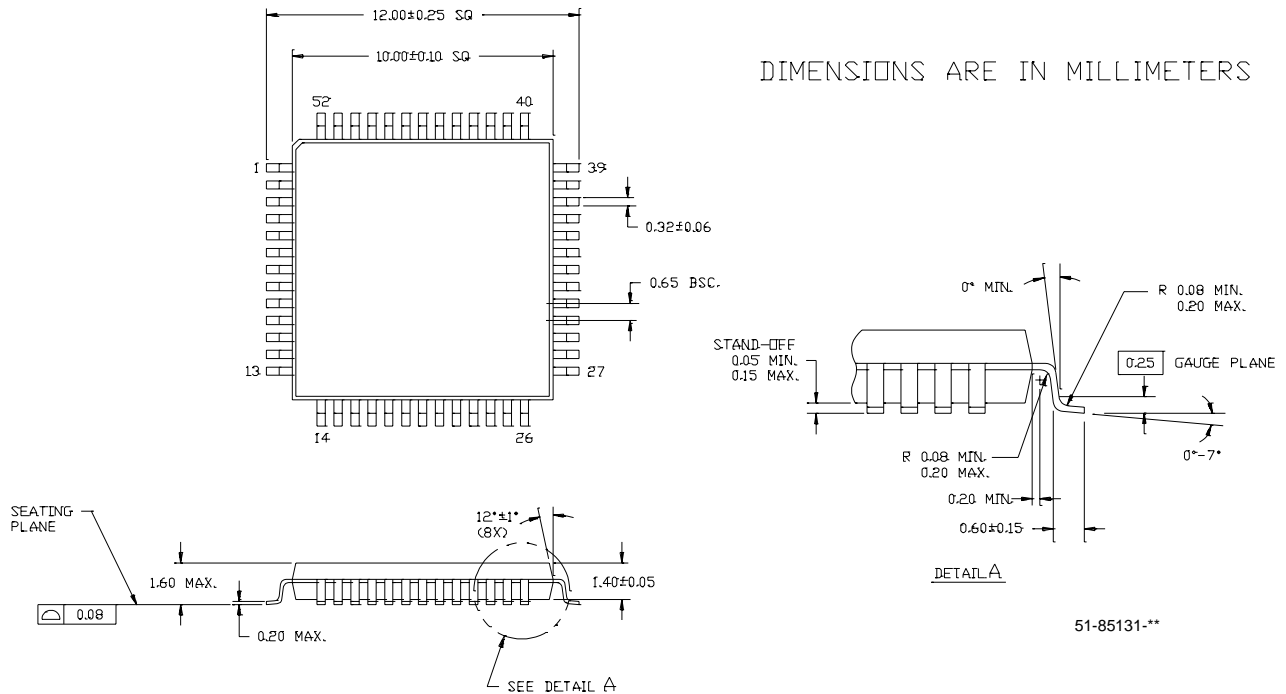
**Package Diagram**
**52-lead Thin Plastic Quad Flat Pack (10 x 10 x 1.4 mm) A52**

RoboClock is a registered trademark, and Total Timing Budget and TTB are trademarks, of Cypress Semiconductor. All product and company names mentioned in this document are the trademarks of their respective holders.

**Document History Page**

Document Title: CY7B9945V RoboClock <sup>®</sup> High-speed Multi-phase PLL Clock Buffer				
Document Number: 38-07336				
REV.	ECN NO.	Issue Date	Orig. of Change	Description of Change
**	111747	03/04/02	CTK	New Data Sheet
*A	116572	09/05/02	HWT	Added TTB Features
*B	119078	10/16/02	HWT	Corrected the following items in the Electrical Characteristics table: $I_{IIL}$ , $I_{IIH}$ , $I_{IIM}$ specifications from: three-level input pins excluding FBFO to FS[0:2], IF[0:3], FBDS[0:1] and FBFO to 2F[0:1], [1:2]DS[0:1], FBFO Common Mode Range ( $V_{COM}$ ) from $V_{CC}$ to $V_{CC}-0.2$ Corrected typo TQFP to LQFP in Features
*C	124645	03/20/03	RGL	Corrected typo LQFP to TQFP in Features
*D	128464	07/25/03	RGL	Added clock input frequency ( $f_{in}$ ) specifications in the switching characteristics table.