

**PowerMOS transistor
Logic level FET**

BUK543-60A/B

GENERAL DESCRIPTION

N-channel enhancement mode logic level field-effect power transistor in a plastic full-pack envelope.
The device is intended for use in Switched Mode Power Supplies (SMPS), motor control, welding, DC/DC and AC/DC converters, and in automotive and general purpose switching applications.

QUICK REFERENCE DATA

SYMBOL	PARAMETER	MAX.	MAX.	UNIT
	BUK543	-60A	-60B	
V_{DS}	Drain-source voltage	60	60	V
I_D	Drain current (DC)	13	12	A
P_{tot}	Total power dissipation	25	25	W
$R_{DS(ON)}$	Drain-source on-state resistance; $V_{GS} = 5\text{ V}$	0.085	0.1	Ω

PINNING - SOT186

PIN	DESCRIPTION
1	gate
2	drain
3	source
case	isolated

PIN CONFIGURATION

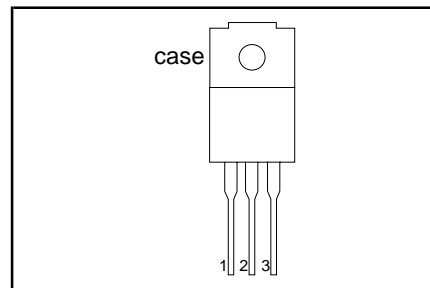

SYMBOL

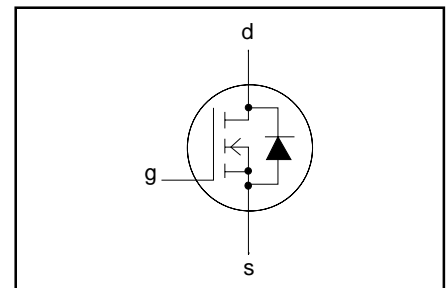

LIMITING VALUES

Limiting values in accordance with the Absolute Maximum System (IEC 134)

SYMBOL	PARAMETER	CONDITIONS	MIN.	MAX.	UNIT
V_{DS}	Drain-source voltage	-	-	60	V
V_{DGR}	Drain-gate voltage	$R_{GS} = 20\text{ k}\Omega$	-	60	V
$\pm V_{GS}$	Gate-source voltage	-	-	15	V
$\pm V_{GSM}$	Non-repetitive gate-source voltage	$t_p \leq 50\ \mu\text{s}$	-	20	V
I_D	Drain current (DC)	$T_{hs} = 25\text{ }^\circ\text{C}$	-	-60A 13	A
I_D	Drain current (DC)	$T_{hs} = 100\text{ }^\circ\text{C}$	-	8.2	A
I_{DM}	Drain current (pulse peak value)	$T_{hs} = 25\text{ }^\circ\text{C}$	-	52	A
P_{tot}	Total power dissipation	$T_{hs} = 25\text{ }^\circ\text{C}$	-	25	W
T_{stg}	Storage temperature	-	-55	150	$^\circ\text{C}$
T_j	Junction Temperature	-	-	150	$^\circ\text{C}$

THERMAL RESISTANCES

SYMBOL	PARAMETER	CONDITIONS	MIN.	TYP.	MAX.	UNIT
$R_{th\ j-hs}$	Thermal resistance junction to heatsink	with heatsink compound	-	-	5.0	K/W
$R_{th\ j-a}$	Thermal resistance junction to ambient		-	55	-	K/W

PowerMOS transistor

Logic level FET

BUK543-60A/B

STATIC CHARACTERISTICS

T_{hs} = 25 °C unless otherwise specified

SYMBOL	PARAMETER	CONDITIONS	MIN.	TYP.	MAX.	UNIT
V _{(BR)DSS}	Drain-source breakdown voltage	V _{GS} = 0 V; I _D = 0.25 mA	60	-	-	V
V _{GS(TO)}	Gate threshold voltage	V _{DS} = V _{GS} ; I _D = 1 mA	1.0	1.5	2.0	V
I _{DSS}	Zero gate voltage drain current	V _{DS} = 60 V; V _{GS} = 0 V; T _j = 25 °C	-	1	10	μA
I _{DSS}	Zero gate voltage drain current	V _{DS} = 60 V; V _{GS} = 0 V; T _j = 125 °C	-	0.1	1.0	mA
I _{GSS}	Gate source leakage current	V _{GS} = ±15 V; V _{DS} = 0 V	-	10	100	nA
R _{DS(ON)}	Drain-source on-state resistance	V _{GS} = 5 V; I _D = 10 A	-	0.075	0.085	Ω
			-	0.08	0.10	Ω

DYNAMIC CHARACTERISTICS

T_{hs} = 25 °C unless otherwise specified

SYMBOL	PARAMETER	CONDITIONS	MIN.	TYP.	MAX.	UNIT
g _{fs}	Forward transconductance	V _{DS} = 25 V; I _D = 10 A	7	10	-	S
C _{iss}	Input capacitance	V _{GS} = 0 V; V _{DS} = 25 V; f = 1 MHz	-	700	825	pF
C _{oss}	Output capacitance		-	240	350	pF
C _{rss}	Feedback capacitance		-	130	160	pF
t _{d on}	Turn-on delay time	V _{DD} = 30 V; I _D = 3 A; V _{GS} = 5 V; R _{GS} = 50 Ω; R _{gen} = 50 Ω	-	20	30	ns
t _r	Turn-on rise time		-	95	120	ns
t _{d off}	Turn-off delay time		-	80	110	ns
t _f	Turn-off fall time		-	65	85	ns
L _d	Internal drain inductance	Measured from drain lead 6 mm from package to centre of die	-	4.5	-	nH
L _s	Internal source inductance	Measured from source lead 6 mm from package to source bond pad	-	7.5	-	nH

ISOLATION LIMITING VALUE & CHARACTERISTIC

T_{hs} = 25 °C unless otherwise specified

SYMBOL	PARAMETER	CONDITIONS	MIN.	TYP.	MAX.	UNIT
V _{isol}	Repetitive peak voltage from all three terminals to external heatsink	R.H. ≤ 65%; clean and dustfree	-		1500	V
C _{isol}	Capacitance from T2 to external heatsink	f = 1 MHz	-	12	-	pF

REVERSE DIODE LIMITING VALUES AND CHARACTERISTICS

T_{hs} = 25 °C unless otherwise specified

SYMBOL	PARAMETER	CONDITIONS	MIN.	TYP.	MAX.	UNIT
I _{DR}	Continuous reverse drain current	-	-	-	13	A
I _{DRM}	Pulsed reverse drain current	-	-	-	52	A
V _{SD}	Diode forward voltage	I _F = 13 A; V _{GS} = 0 V	-	1.1	1.3	V
t _{rr}	Reverse recovery time	I _F = 13 A; -di _F /dt = 100 A/μs;	-	60	-	ns
Q _{rr}	Reverse recovery charge	V _{GS} = 0 V; V _R = 30 V	-	0.20	-	μC

PowerMOS transistor
Logic level FET

BUK543-60A/B

AVALANCHE LIMITING VALUE

$T_{hs} = 25\text{ }^{\circ}\text{C}$ unless otherwise specified

SYMBOL	PARAMETER	CONDITIONS	MIN.	TYP.	MAX.	UNIT
W_{DSS}	Drain-source non-repetitive unclamped inductive turn-off energy	$I_D = 20\text{ A}$; $V_{DD} \leq 25\text{ V}$; $V_{GS} = 5\text{ V}$; $R_{GS} = 50\text{ }\Omega$	-	-	45	mJ

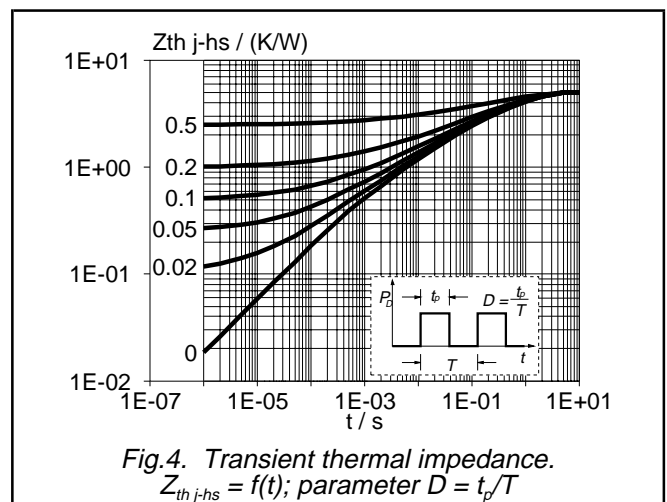
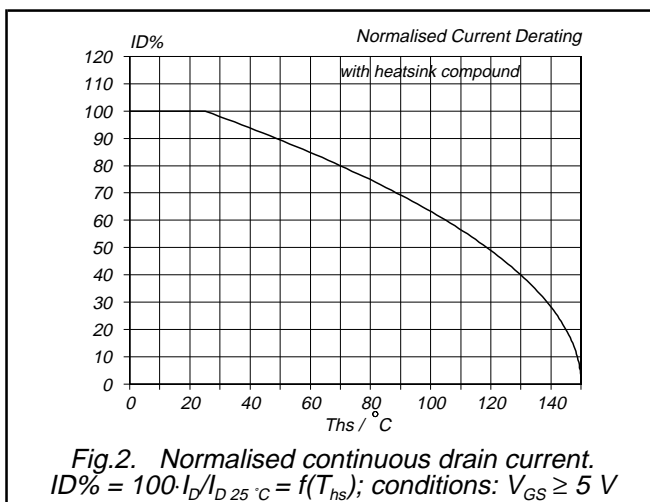
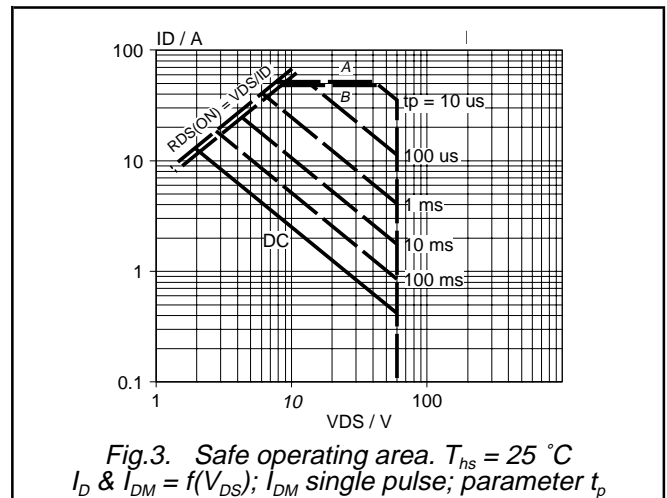
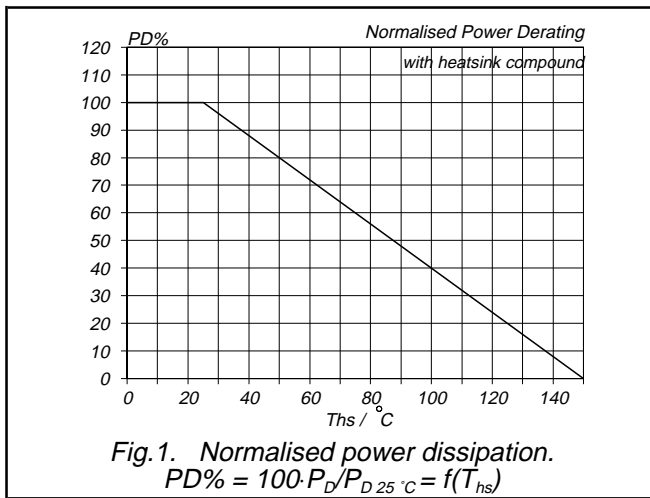

PowerMOS transistor
Logic level FET

BUK543-60A/B

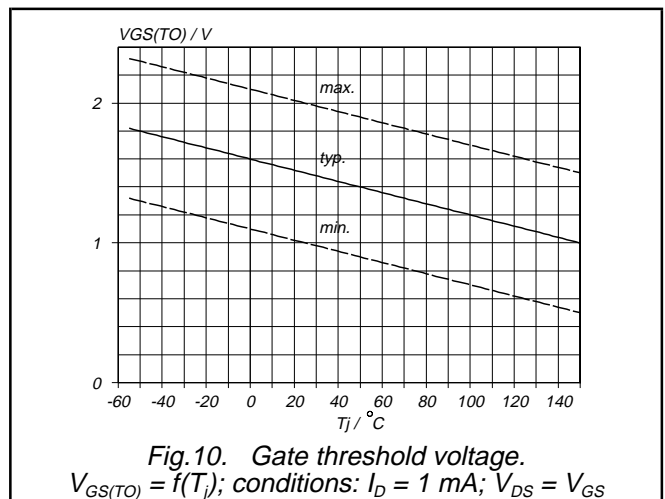
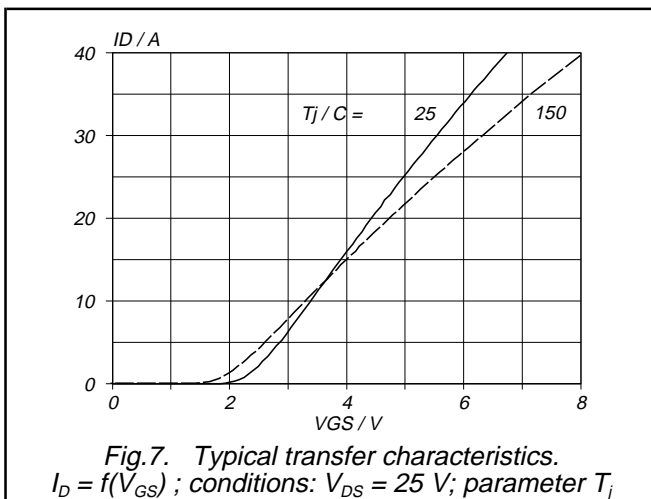
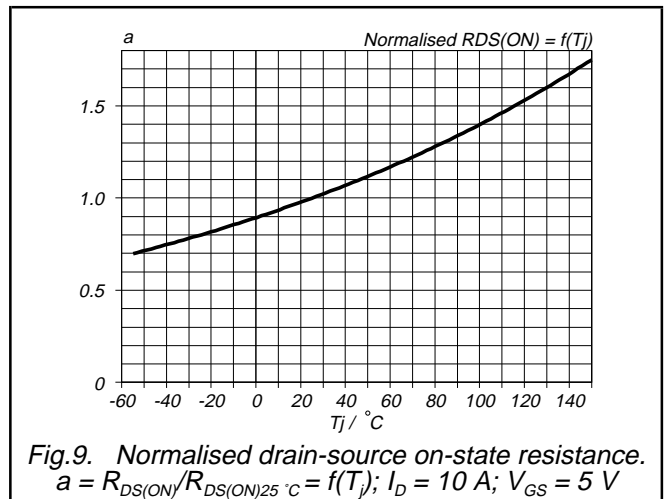
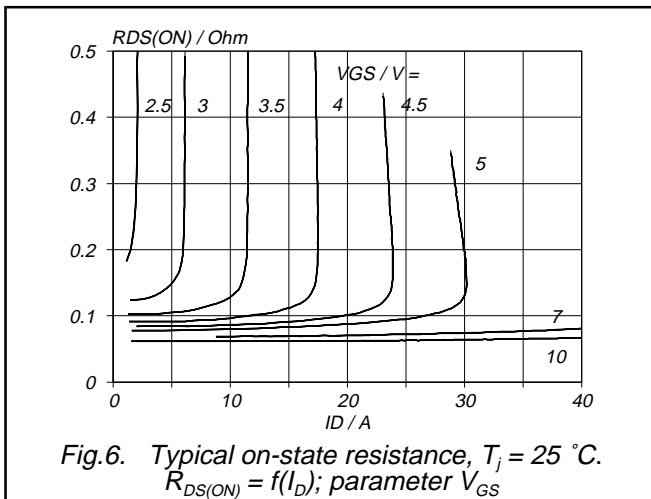
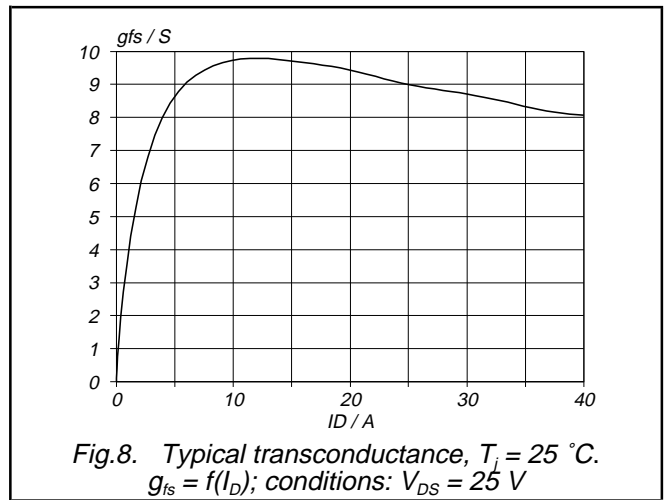
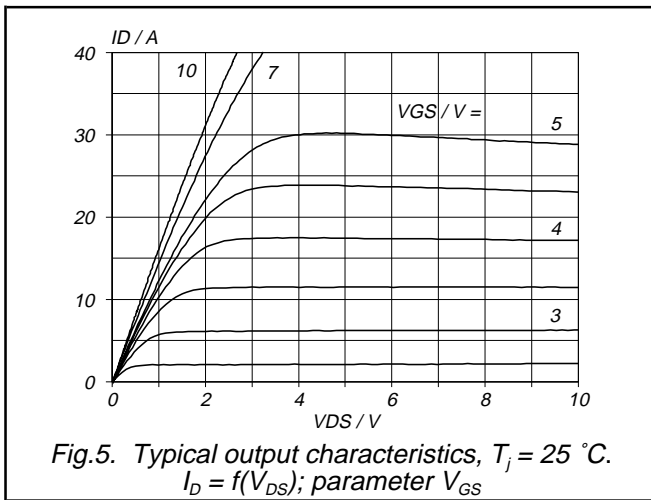

PowerMOS transistor
Logic level FET

BUK543-60A/B

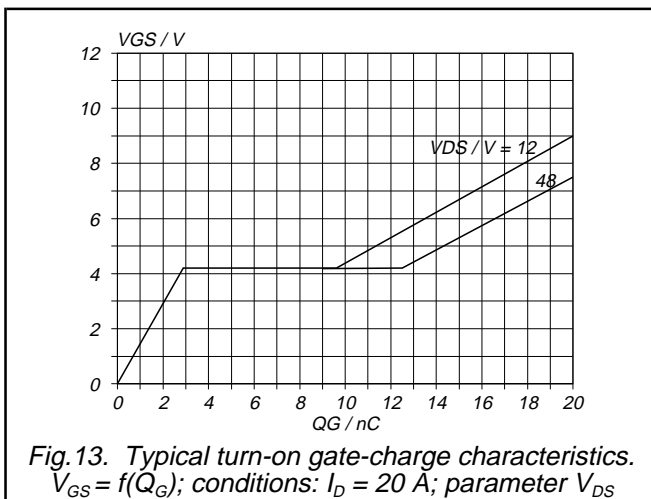
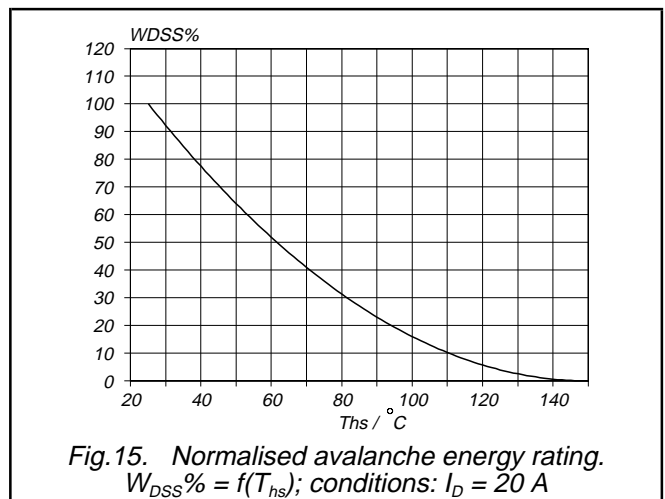
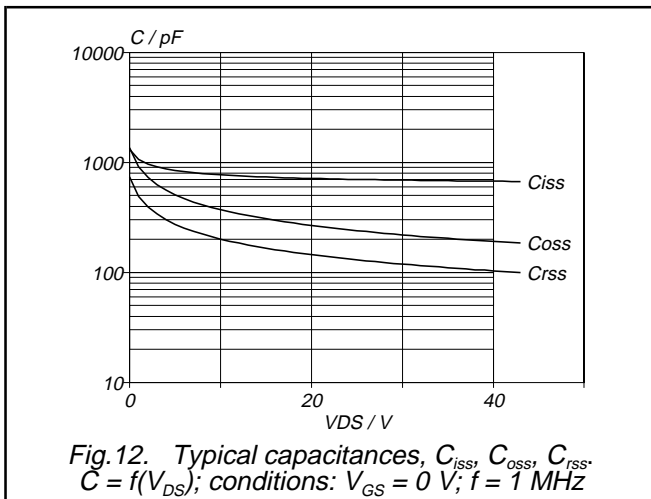
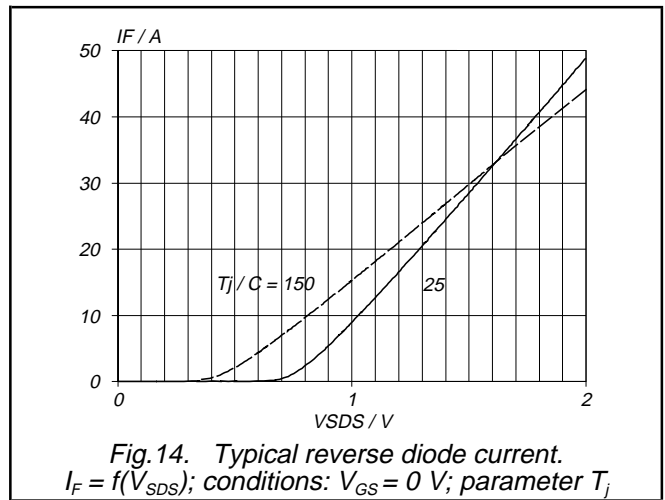
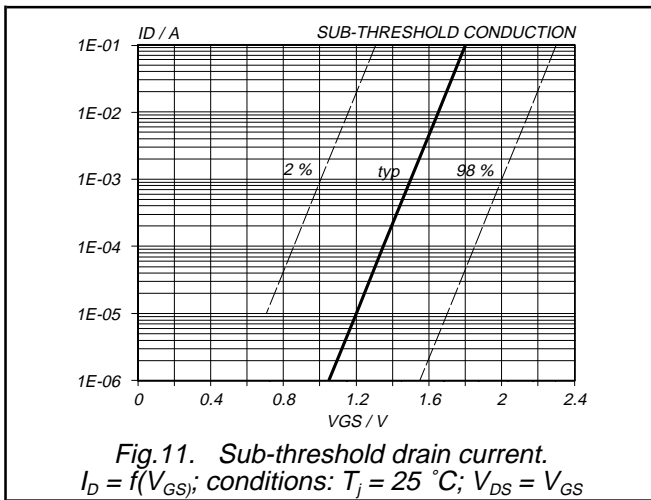

PowerMOS transistor
Logic level FET

BUK543-60A/B

MECHANICAL DATA

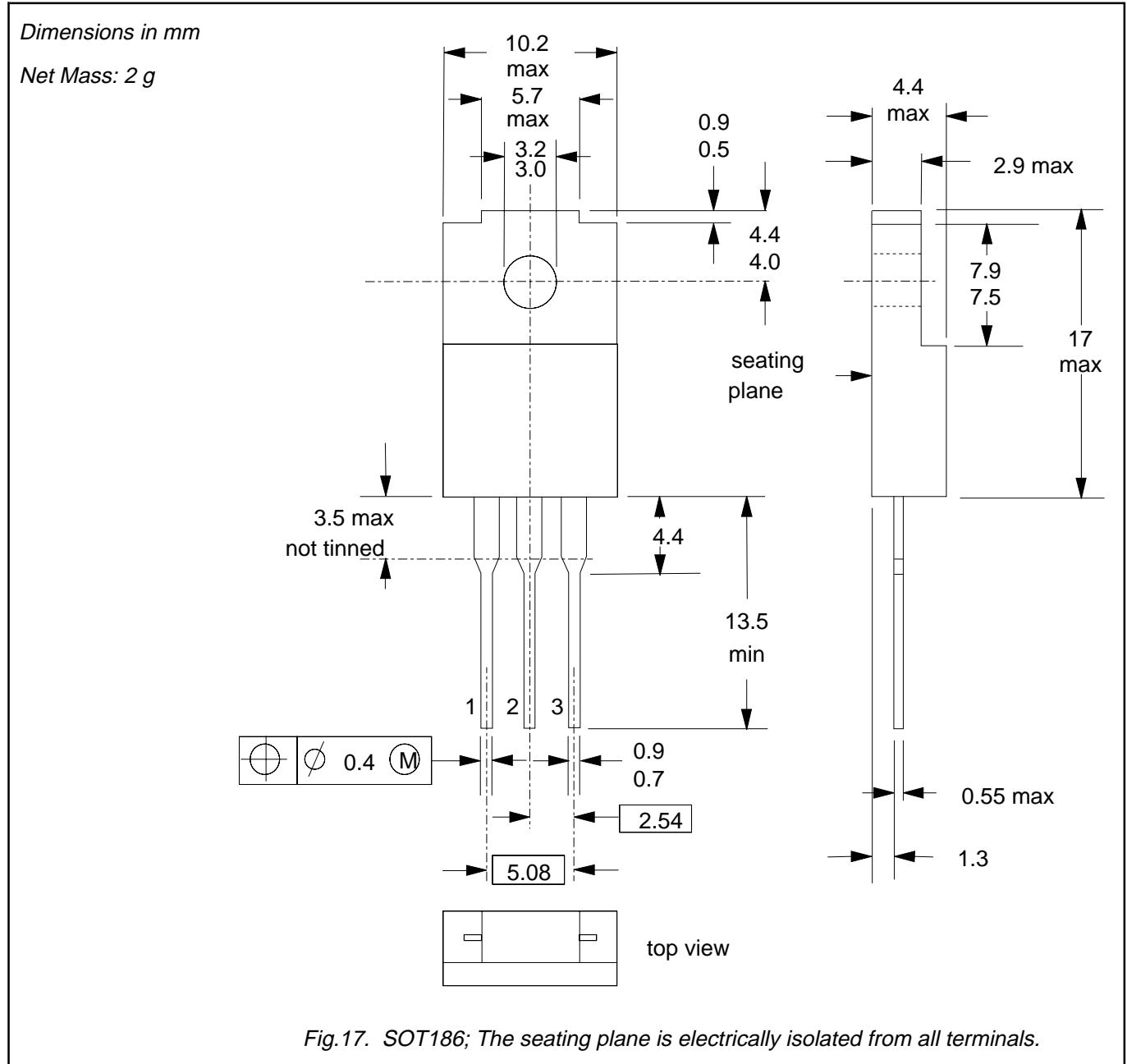

Notes

1. Observe the general handling precautions for electrostatic-discharge sensitive devices (ESDs) to prevent damage to MOS gate oxide.
2. Refer to mounting instructions for F-pack envelopes.
3. Epoxy meets UL94 V0 at 1/8".

PowerMOS transistor
Logic level FET

BUK543-60A/B

DEFINITIONS

Data sheet status	
Objective specification	This data sheet contains target or goal specifications for product development.
Preliminary specification	This data sheet contains preliminary data; supplementary data may be published later.
Product specification	This data sheet contains final product specifications.
Limiting values	
Limiting values are given in accordance with the Absolute Maximum Rating System (IEC 134). Stress above one or more of the limiting values may cause permanent damage to the device. These are stress ratings only and operation of the device at these or at any other conditions above those given in the Characteristics sections of this specification is not implied. Exposure to limiting values for extended periods may affect device reliability.	
Application information	
Where application information is given, it is advisory and does not form part of the specification.	
© Philips Electronics N.V. 1996	
All rights are reserved. Reproduction in whole or in part is prohibited without the prior written consent of the copyright owner.	
The information presented in this document does not form part of any quotation or contract, it is believed to be accurate and reliable and may be changed without notice. No liability will be accepted by the publisher for any consequence of its use. Publication thereof does not convey nor imply any license under patent or other industrial or intellectual property rights.	

LIFE SUPPORT APPLICATIONS

These products are not designed for use in life support appliances, devices or systems where malfunction of these products can be reasonably expected to result in personal injury. Philips customers using or selling these products for use in such applications do so at their own risk and agree to fully indemnify Philips for any damages resulting from such improper use or sale.

- 1) Level: Format Error
Message: Page break required with Keep enabled
Location: Document Body