

BR7.62

Features

- LED FIRMLY HELD BY SPACER.
- SUITABLE FOR BACK PANEL ILLUMINATION, CIRCUIT BOARD INDICATOR, LED INDICATOR.
- UL RATING : 94V-0.
- HOUSING MATERIAL: TYPE 66 NYLON.
- RoHS COMPLIANT.

Package Dimensions

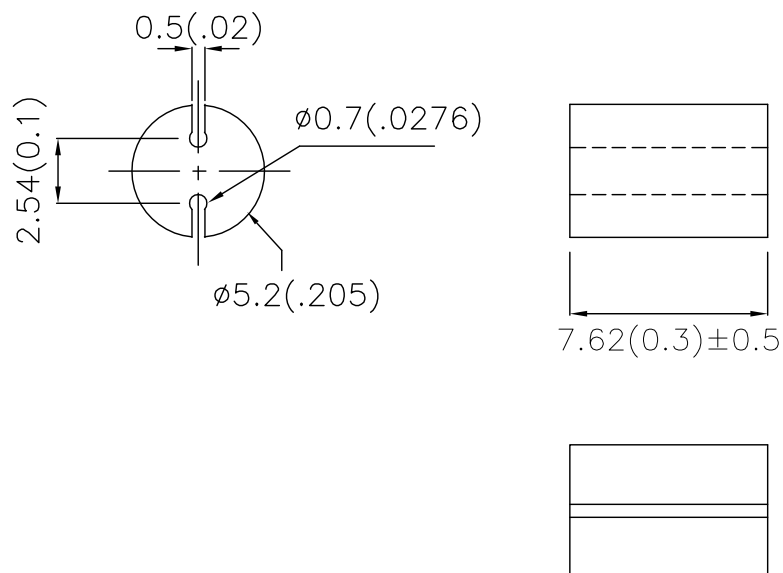

Notes:

1. All dimensions are in millimeters (inches).
2. Tolerance is $\pm 0.25(0.01)$ unless otherwise noted.
3. Specifications are subject to change without notice.

PACKING & LABEL SPECIFICATIONS

BR7.62

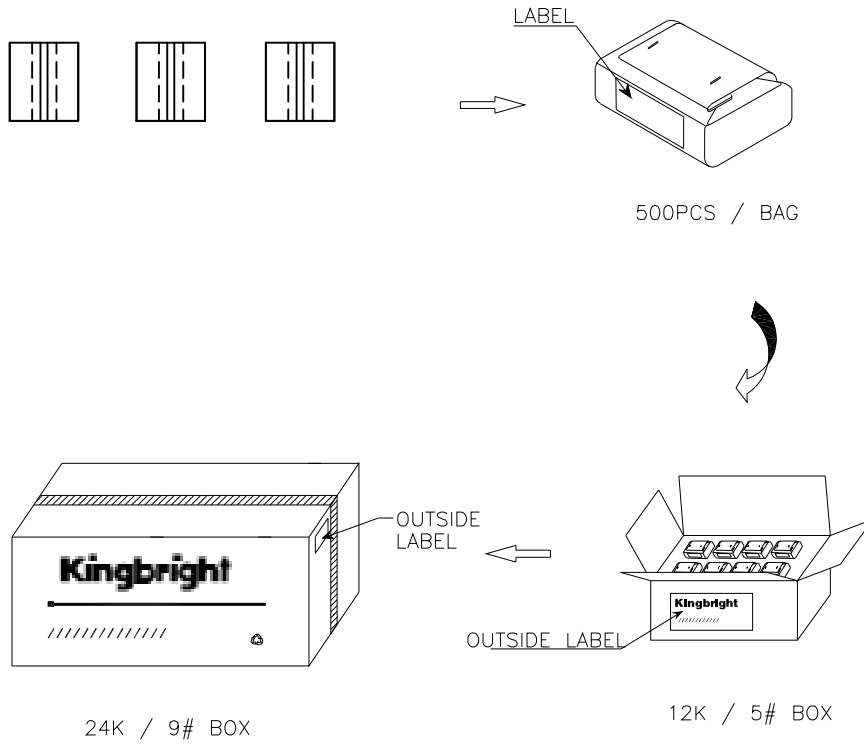

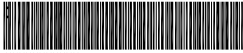
Kingbright				
Q.C.	<table border="1"> <tr> <td style="text-align: center;">QC</td> </tr> <tr> <td style="text-align: center;">xx xx xx</td> </tr> <tr> <td style="text-align: center;">PASSED</td> </tr> </table>	QC	xx xx xx	PASSED
QC				
xx xx xx				
PASSED				
TYPE NO :	BRxx			
QUANTITY :	500 pcs			
S/N :	xxx			
	CODE: XX			
LOT NO	 xxxxxxxxxx			
RoHS Compliant				