

APT B1612ESGC

HIGH EFFICIENCY RED
SUPER BRIGHT GREEN

Features

- 1.6mmx1.25mm SMT LED, 0.65mm THICKNESS.
- BI-COLOR, LOW POWER CONSUMPTION.
- WIDE VIEWING ANGLE.
- IDEAL FOR BACKLIGHT AND INDICATOR.
- VARIOUS COLORS AND LENS TYPES AVAILABLE.
- PACKAGE : 2000PCS / REEL.

Description

The High Efficiency Red source color devices are made with Gallium Arsenide Phosphide on Gallium Phosphide Orange Light Emitting Diode.

The Super Bright Green source color devices are made with Gallium Phosphide Green Light Emitting Diode.

Package Dimensions

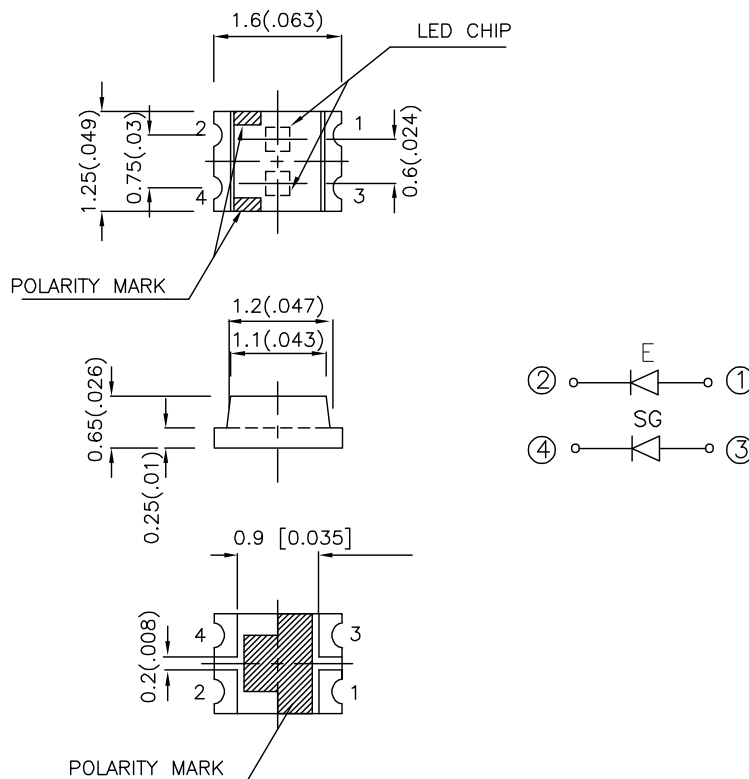

Notes:

1. All dimensions are in millimeters (inches).
2. Tolerance is $\pm 0.2(0.008)$ unless otherwise noted.
3. Specifications are subject to change without notice.

Selection Guide

Part No.	Dice	Lens Type	Iv (mcd) @ 20mA		Viewing Angle
			Min.	Typ.	2θ1/2
APT B1612ESGC	HIGH EFFICIENCY RED (GaAsP/GaP)	WATER CLEAR	4	12	120°
	SUPER BRIGHT GREEN (GaP)		4	12	

Note:

1. θ1/2 is the angle from optical centerline where the luminous intensity is 1/2 the optical centerline value.

Electrical / Optical Characteristics at TA=25°C

Symbol	Parameter	Device	Typ.	Max.	Units	Test Conditions
λ_{peak}	Peak Wavelength	High Efficiency Red Super Bright Green	627 565		nm	IF=20mA
λ_D	Dominant Wavelength	High Efficiency Red Super Bright Green	625 568		nm	IF=20mA
$\Delta\lambda_{1/2}$	Spectral Line Half-width	High Efficiency Red Super Bright Green	45 30		nm	IF=20mA
C	Capacitance	High Efficiency Red Super Bright Green	15 15		pF	VF=0V;f=1MHz
VF	Forward Voltage	High Efficiency Red Super Bright Green	2.0 2.2	2.5 2.5	V	IF=20mA
IR	Reverse Current	All		10	uA	VR = 5V

Absolute Maximum Ratings at TA=25°C

Parameter	High Efficiency Red	Super Bright Green	Units
Power dissipation	105	105	mW
DC Forward Current	30	25	mA
Peak Forward Current [1]	160	140	mA
Reverse Voltage	5		V
Operating / Storage Temperature	-40°C To +85°C		

Note:

1. 1/10 Duty Cycle, 0.1ms Pulse Width.

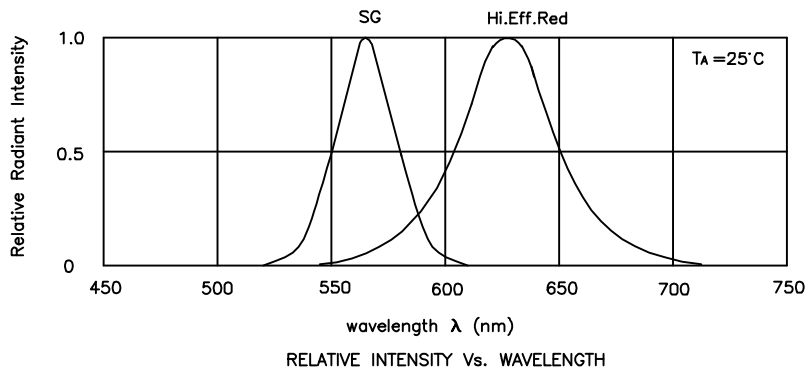

APTB1612ESGC High Efficiency Red

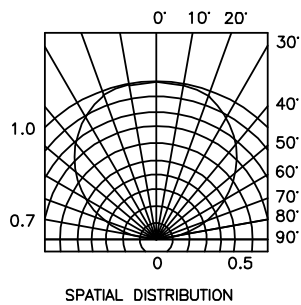
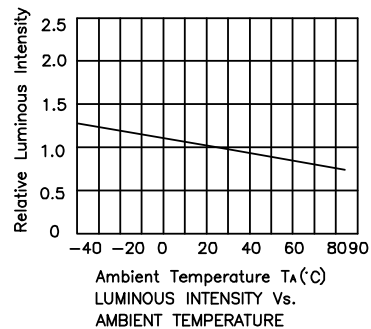
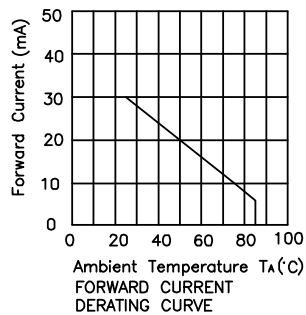
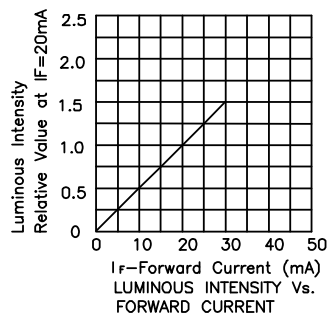
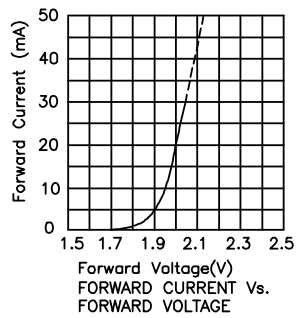

Kingbright

Super Bright Green

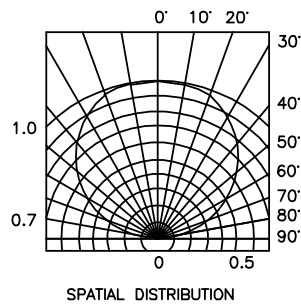
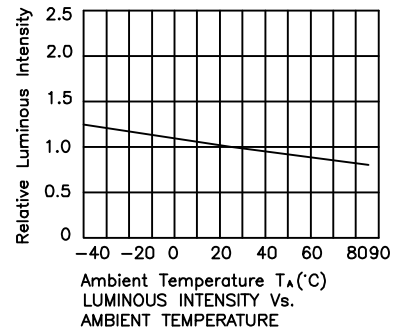
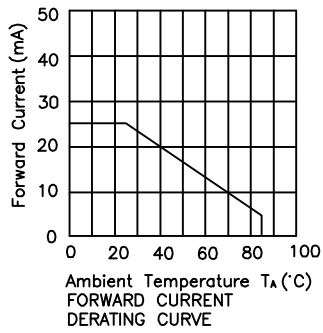
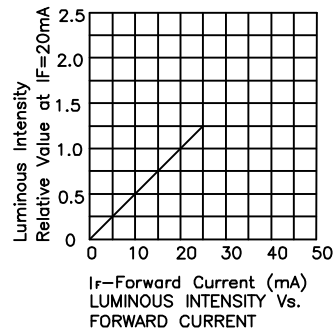
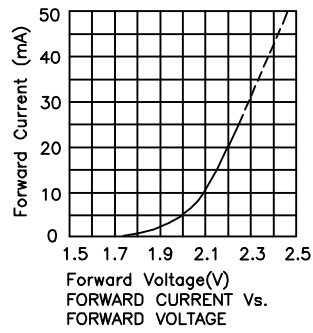

APTB1612ESGC

SMT Reflow Soldering Instructions

Number of reflow process shall be 2 times or less and cooling process to normal temperature is required between first and second soldering process.

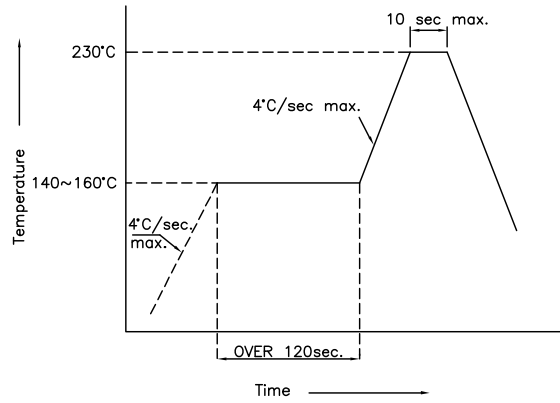

Recommended Soldering Pattern (Units : mm)

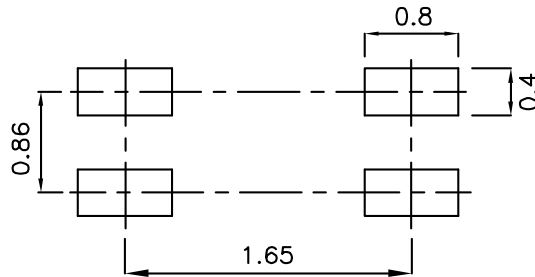

Tape Specifications (Units : mm)

