

## 74LCXH32245

### Low Voltage 32-Bit Bidirectional Transceiver with 5V Tolerant Inputs and Outputs with Bushold

#### General Description

The LCXH32245 contains thirty-two non-inverting bidirectional buffers with 3-STATE outputs and is intended for bus oriented applications. The device is designed for low voltage (2.5V or 3.3V)  $V_{CC}$  applications with capability of interfacing to a 5V signal environment. The device is byte controlled. Each byte has separate control inputs which could be shorted together for full 32-bit operation. The T/R inputs determine the direction of data flow through the device. The OE inputs disable both the A and B ports by placing them in a high impedance state.

The LCXH32245 data inputs include bushold, eliminating the need for external pull-up/down resistors to hold unused inputs.

The LCXH32245 is fabricated with an advanced CMOS technology to achieve high speed operation while maintaining CMOS low power dissipation.

#### Features

- 5V tolerant inputs and outputs
  - 2.3V to 3.6V  $V_{CC}$  specifications provided
  - 4.5 ns  $t_{PD}$  max ( $V_{CC} = 3.3V$ ), 20  $\mu A$   $I_{CC}$  max
  - Power-off high impedance inputs and outputs
  - Bushold on inputs eliminates the need for external pull-up/down resistors
  - Supports live insertion/withdrawal (Note 1)
  - $\pm 24$  mA output drive ( $V_{CC} = 3.0V$ )
  - Uses patented noise/EMI reduction circuitry
  - Latch-up performance exceeds 500 mA
  - ESD performance:
    - Human body model > 2000V
    - Machine model > 200V
  - Packaged in plastic Fine-Pitch Ball Grid Array (FBGA)
- Note 1:** To ensure the high-impedance state during power-up or down, OE should be tied to VCC through a pull-up resistor; the minimum value or the resistor is determined by the current-sourcing capability of the driver.

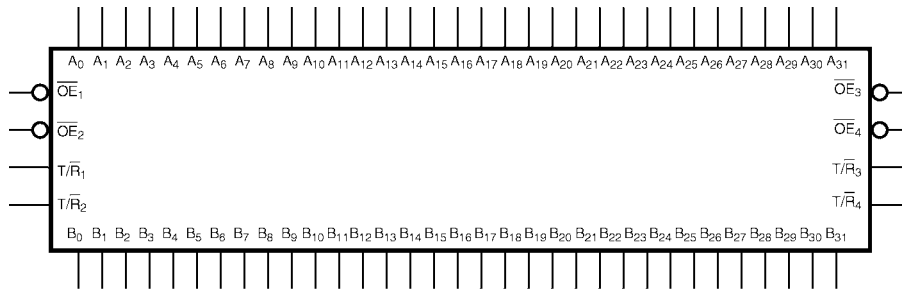
#### Ordering Code:

Order Number	Package Number	Package Description
74LCXH32245G (Note 2) (Note 3)	BGA96A	96-Ball Fine-Pitch Ball Grid Array (FBGA), JEDEC MO-205, 5.5mm Wide

**Note 2:** Ordering Code "G" indicates Trays.

**Note 3:** Devices also available in Tape and Reel. Specify by appending the suffix letter "X" to the ordering code.

#### Logic Symbol



74LCXH32245 Low Voltage 32-Bit Bidirectional Transceiver with 5V Tolerant Inputs and Outputs with Bushold

**Connection Diagram**



(Top Thru View)

**Pin Descriptions**

Pin Names	Description
$\overline{OE}_n$	Output Enable Input (Active LOW)
$T/\overline{R}_n$	Transmit/Receive Input
$A_0$ – $A_{31}$	Side A Inputs/3-STATE Outputs
$B_0$ – $B_{31}$	Side B Inputs/3-STATE Outputs

**FBGA Pin Assignments**

	1	2	3	4	5	6
<b>A</b>	B <sub>1</sub>	B <sub>0</sub>	$T/\overline{R}_1$	$\overline{OE}_1$	A <sub>0</sub>	A <sub>1</sub>
<b>B</b>	B <sub>3</sub>	B <sub>2</sub>	GND	GND	A <sub>2</sub>	A <sub>3</sub>
<b>C</b>	B <sub>5</sub>	B <sub>4</sub>	V <sub>CC1</sub>	V <sub>CC1</sub>	A <sub>4</sub>	A <sub>5</sub>
<b>D</b>	B <sub>7</sub>	B <sub>6</sub>	GND	GND	A <sub>6</sub>	A <sub>7</sub>
<b>E</b>	B <sub>9</sub>	B <sub>8</sub>	GND	GND	A <sub>8</sub>	A <sub>9</sub>
<b>F</b>	B <sub>11</sub>	B <sub>10</sub>	V <sub>CC1</sub>	V <sub>CC1</sub>	A <sub>10</sub>	A <sub>11</sub>
<b>G</b>	B <sub>13</sub>	B <sub>12</sub>	GND	GND	A <sub>12</sub>	A <sub>13</sub>
<b>H</b>	B <sub>14</sub>	B <sub>15</sub>	$T/\overline{R}_2$	$\overline{OE}_2$	A <sub>15</sub>	A <sub>14</sub>
<b>J</b>	B <sub>17</sub>	B <sub>16</sub>	$T/\overline{R}_3$	$\overline{OE}_3$	A <sub>16</sub>	A <sub>17</sub>
<b>K</b>	B <sub>19</sub>	B <sub>18</sub>	GND	GND	A <sub>18</sub>	A <sub>19</sub>
<b>L</b>	B <sub>21</sub>	B <sub>20</sub>	V <sub>CC2</sub>	V <sub>CC2</sub>	A <sub>20</sub>	A <sub>21</sub>
<b>M</b>	B <sub>23</sub>	B <sub>22</sub>	GND	GND	A <sub>22</sub>	A <sub>23</sub>
<b>N</b>	B <sub>25</sub>	B <sub>24</sub>	GND	GND	A <sub>24</sub>	A <sub>25</sub>
<b>P</b>	B <sub>27</sub>	B <sub>26</sub>	V <sub>CC2</sub>	V <sub>CC2</sub>	A <sub>26</sub>	A <sub>27</sub>
<b>R</b>	B <sub>29</sub>	B <sub>28</sub>	GND	GND	A <sub>28</sub>	A <sub>29</sub>
<b>T</b>	B <sub>30</sub>	B <sub>31</sub>	$T/\overline{R}_4$	$\overline{OE}_4$	A <sub>31</sub>	A <sub>30</sub>

**Truth Tables**

Inputs		Outputs
$\overline{OE}_1$	$T/\overline{R}_1$	
L	L	Bus B <sub>0</sub> –B <sub>7</sub> Data to Bus A <sub>0</sub> –A <sub>7</sub>
L	H	Bus A <sub>0</sub> –A <sub>7</sub> Data to Bus B <sub>0</sub> –B <sub>7</sub>
H	X	HIGH-Z State on A <sub>0</sub> –A <sub>7</sub> , B <sub>0</sub> –B <sub>7</sub>

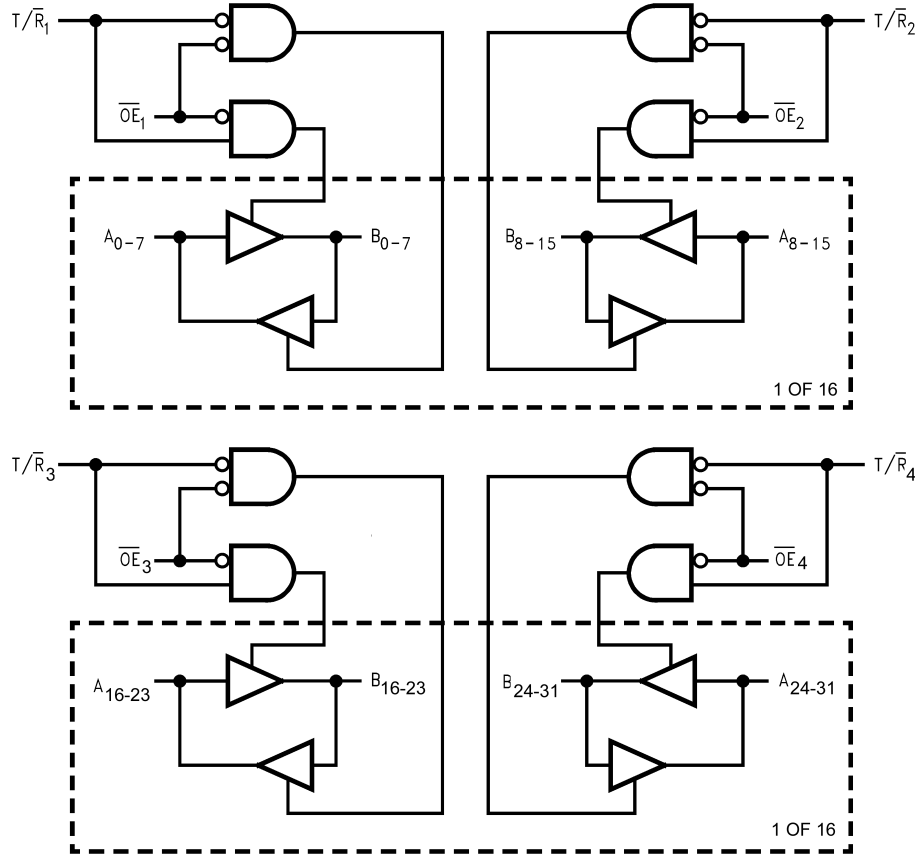
Inputs		Outputs
$\overline{OE}_3$	$T/\overline{R}_3$	
L	L	Bus B <sub>16</sub> –B <sub>23</sub> Data to Bus A <sub>16</sub> –A <sub>23</sub>
L	H	Bus A <sub>16</sub> –A <sub>23</sub> Data to Bus B <sub>16</sub> –B <sub>23</sub>
H	X	HIGH-Z State on A <sub>16</sub> –A <sub>23</sub> , B <sub>16</sub> –B <sub>23</sub>

Inputs		Outputs
$\overline{OE}_2$	$T/\overline{R}_2$	
L	L	Bus B <sub>8</sub> –B <sub>15</sub> Data to Bus A <sub>8</sub> –A <sub>15</sub>
L	H	Bus A <sub>8</sub> –A <sub>15</sub> Data to Bus B <sub>8</sub> –B <sub>15</sub>
H	X	HIGH-Z State on A <sub>8</sub> –A <sub>15</sub> , B <sub>8</sub> –B <sub>15</sub>

Inputs		Outputs
$\overline{OE}_4$	$T/\overline{R}_4$	
L	L	Bus B <sub>24</sub> –B <sub>31</sub> Data to Bus A <sub>24</sub> –A <sub>31</sub>
L	H	Bus B <sub>24</sub> –A <sub>31</sub> Data to Bus B <sub>24</sub> –B <sub>31</sub>
H	X	HIGH-Z State on A <sub>24</sub> –A <sub>31</sub> , B <sub>24</sub> –B <sub>31</sub>

H = HIGH Voltage Level  
 L = LOW Voltage Level  
 X = Immaterial  
 Z = High Impedance

**Logic Diagrams**



**Note:** Please note that these diagrams are provided only for the understanding of logic operations and should not be used to estimate propagation delays.

Absolute Maximum Ratings (Note 4)						
Symbol	Parameter	Value	Conditions	Units		
V <sub>CC</sub>	Supply Voltage	-0.5 to +7.0		V		
V <sub>I</sub>	T/R, $\overline{OE}$ I/O Ports	-0.5 to +7.0 -0.5 to V <sub>CC</sub> + 0.5		V		
V <sub>O</sub>	DC Output Voltage	-0.5 to +7.0 -0.5 to V <sub>CC</sub> + 0.5	Output in 3-STATE Output in HIGH or LOW State (Note 5)	V		
I <sub>IK</sub>	DC Input Diode Current	-50	V <sub>I</sub> < GND	mA		
I <sub>OK</sub>	DC Output Diode Current	-50 +50	V <sub>O</sub> < GND V <sub>O</sub> > V <sub>CC</sub>	mA		
I <sub>O</sub>	DC Output Source/Sink Current	±50		mA		
I <sub>CC</sub>	DC Supply Current per Supply Pin	±100		mA		
I <sub>GND</sub>	DC Ground Current per Ground Pin	±100		mA		
T <sub>STG</sub>	Storage Temperature	-65 to +150		°C		
Recommended Operating Conditions (Note 6)						
Symbol	Parameter	Min	Max	Units		
V <sub>CC</sub>	Supply Voltage	Operating	2.0	3.6	V	
		Data Retention	1.5	3.6		
V <sub>I</sub>	Input Voltage	0	V <sub>CC</sub>	V		
V <sub>O</sub>	Output Voltage	HIGH or LOW State	0	V <sub>CC</sub>	V	
		3-STATE	0	5.5		
I <sub>OH</sub> /I <sub>OL</sub>	Output Current	V <sub>CC</sub> = 3.0V – 3.6V		±24	mA	
		V <sub>CC</sub> = 2.7V – 3.0V		±12		
		V <sub>CC</sub> = 2.3V – 2.7V		±8		
T <sub>A</sub>	Free-Air Operating Temperature	-40	85	°C		
Δt/ΔV	Input Edge Rate, V <sub>IN</sub> = 0.8V–2.0V, V <sub>CC</sub> = 3.0V	0	10	ns/V		
<p><b>Note 4:</b> The Absolute Maximum Ratings are those values beyond which the safety of the device cannot be guaranteed. The device should not be operated at these limits. The parametric values defined in the Electrical Characteristics tables are not guaranteed at the Absolute Maximum Ratings. The "Recommended Operating Conditions" table will define the conditions for actual device operation.</p> <p><b>Note 5:</b> I<sub>O</sub> Absolute Maximum Rating must be observed.</p> <p><b>Note 6:</b> Floating or unused control inputs must be HIGH or LOW.</p>						
DC Electrical Characteristics						
Symbol	Parameter	Conditions	V <sub>CC</sub> (V)	T <sub>A</sub> = -40°C to +85°C		Units
				Min	Max	
V <sub>IH</sub>	HIGH Level Input Voltage		2.3 – 2.7	1.7		V
			2.7 – 3.6	2.0		
V <sub>IL</sub>	LOW Level Input Voltage		2.3 – 2.7		0.7	V
			2.7 – 3.6		0.8	
V <sub>OH</sub>	HIGH Level Output Voltage	I <sub>OH</sub> = -100 μA	2.3 – 3.6	V <sub>CC</sub> - 0.2		V
		I <sub>OH</sub> = -8 mA	2.3	1.8		
		I <sub>OH</sub> = -12 mA	2.7	2.2		
		I <sub>OH</sub> = -18 mA	3.0	2.4		
		I <sub>OH</sub> = -24 mA	3.0	2.2		
V <sub>OL</sub>	LOW Level Output Voltage	I <sub>OL</sub> = 100 μA	2.3 – 3.6		0.2	V
		I <sub>OL</sub> = 8 mA	2.3		0.6	
		I <sub>OL</sub> = 12 mA	2.7		0.4	
		I <sub>OL</sub> = 16 mA	3.0		0.4	
		I <sub>OL</sub> = 24 mA	3.0		0.55	

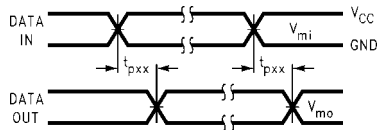
DC Electrical Characteristics (Continued)								
Symbol	Parameter	Conditions	V <sub>CC</sub> (V)	T <sub>A</sub> = -40°C to +85°C		Units		
				Min	Max			
I <sub>I</sub>	Input Leakage Current	0 ≤ V <sub>I</sub> ≤ 5.5V	2.3 – 3.6		±5.0	μA		
I <sub>I(HOLD)</sub>	Bushold Input Minimum Drive Hold Current	V <sub>IN</sub> = 0.7V	2.3	45				
		V <sub>IN</sub> = 1.7V		-45				
		V <sub>IN</sub> = 0.8V	3.0	75				
I <sub>I(OD)</sub>	Bushold Input Over-Drive Current to Change State	(Note 7)	2.7	300		μA		
		(Note 8)		-300				
		(Note 7)	3.6	450				
		(Note 8)		-450				
I <sub>OZ</sub>	3-STATE I/O Leakage	0 ≤ V <sub>O</sub> ≤ 5.5V V <sub>I</sub> = V <sub>IH</sub> or V <sub>IL</sub>	2.3 – 3.6		±5.0	μA		
I <sub>OFF</sub>	Power-Off Leakage Current	V <sub>I</sub> or V <sub>O</sub> = 5.5V	0		10	μA		
I <sub>CC</sub>	Quiescent Supply Current	V <sub>I</sub> = V <sub>CC</sub> or GND	2.3–3.6		20	μA		
		3.6V ≤ V <sub>I</sub> , V <sub>O</sub> ≤ 5.5V (Note 9)	2.3–3.6		±20			
ΔI <sub>CC</sub>	Increase in I <sub>CC</sub> per Input	V <sub>IH</sub> = V <sub>CC</sub> – 0.6V	2.3–3.6		500	μA		
<b>Note 7:</b> An external driver must source at least the specified current to switch from LOW-to-HIGH. <b>Note 8:</b> An external driver must sink at least the specified current to switch from HIGH-to-LOW. <b>Note 9:</b> Outputs disabled or 3-STATE only.								
AC Electrical Characteristics								
Symbol	Parameter	T <sub>A</sub> = -40°C to +85°C, R <sub>L</sub> = 500Ω						Units
		V <sub>CC</sub> = 3.3V ± 0.3V		V <sub>CC</sub> = 2.7V		V <sub>CC</sub> = 2.5V ± 0.2V		
		C <sub>L</sub> = 50 pF		C <sub>L</sub> = 50 pF		C <sub>L</sub> = 30 pF		
		Min	Max	Min	Max	Min	Max	
t <sub>PHL</sub>	Propagation Delay	1.0	4.5	1.0	5.2	1.0	5.4	ns
t <sub>PLH</sub>	A <sub>n</sub> to B <sub>n</sub> or B <sub>n</sub> to A <sub>n</sub>	1.0	4.5	1.0	5.2	1.0	5.4	
t <sub>PZL</sub>	Output Enable Time	1.0	6.5	1.0	7.2	1.0	8.5	ns
t <sub>PZH</sub>	Output Disable Time	1.0	6.5	1.0	7.2	1.0	8.5	
t <sub>PLZ</sub>	Output Disable Time	1.0	6.4	1.0	6.9	1.0	7.7	ns
t <sub>PHZ</sub>	Output Enable Time	1.0	6.4	1.0	6.9	1.0	7.7	
Dynamic Switching Characteristics								
Symbol	Parameter	Conditions	V <sub>CC</sub> (V)	T <sub>A</sub> = 25°C		Units		
				Typical				
V <sub>OLP</sub>	Quiet Output Dynamic Peak V <sub>OL</sub>	C <sub>L</sub> = 50 pF, V <sub>IH</sub> = 3.3V, V <sub>IL</sub> = 0V	3.3	0.8	V			
		C <sub>L</sub> = 30 pF, V <sub>IH</sub> = 2.5V, V <sub>IL</sub> = 0V	2.5	0.6				
V <sub>OLV</sub>	Quiet Output Dynamic Valley V <sub>OL</sub>	C <sub>L</sub> = 50 pF, V <sub>IH</sub> = 3.3V, V <sub>IL</sub> = 0V	3.3	-0.8	V			
		C <sub>L</sub> = 30 pF, V <sub>IH</sub> = 2.5V, V <sub>IL</sub> = 0V	2.5	-0.6				
Capacitance								
Symbol	Parameter	Conditions	Typical	Units				
C <sub>IN</sub>	Input Capacitance	V <sub>CC</sub> = Open, V <sub>I</sub> = 0V or V <sub>CC</sub>	7	pF				
C <sub>I/O</sub>	Input/Output Capacitance	V <sub>CC</sub> = 3.3V, V <sub>I</sub> = 0V or V <sub>CC</sub>	8	pF				
C <sub>PD</sub>	Power Dissipation Capacitance	V <sub>CC</sub> = 3.3V, V <sub>I</sub> = 0V or V <sub>CC</sub> , f = 10 MHz	20	pF				

**AC LOADING and WAVEFORMS** Generic for LCX Family

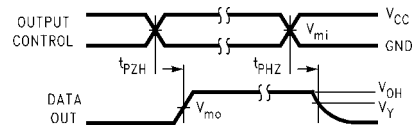


**FIGURE 1. AC Test Circuit ( $C_L$  includes probe and jig capacitance)**

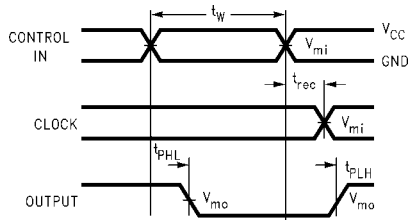
Test	Switch
$t_{PLH}, t_{PHL}$	Open
$t_{PZL}, t_{PLZ}$	6V at $V_{CC} = 3.3 \pm 0.3V$ , and 2.7V $V_{CC} \times 2$ at $V_{CC} = 2.5 \pm 0.2V$
$t_{PZH}, t_{PHZ}$	GND



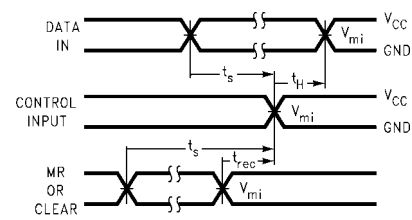
**Waveform for Inverting and Non-Inverting Functions**



**3-STATE Output High Enable and Disable Times for Logic**



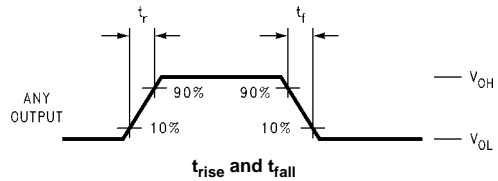
**Propagation Delay, Pulse Width and  $t_{rec}$  Waveforms**



**Setup Time, Hold Time and Recovery Time for Logic**



**3-STATE Output Low Enable and Disable Times for Logic**



**FIGURE 2. Waveforms (Input Characteristics;  $f = 1MHz$ ,  $t_r = t_f = 3ns$ )**

Symbol	$V_{CC}$		
	$3.3V \pm 0.3V$	2.7V	$2.5V \pm 0.2V$
$V_{mi}$	1.5V	1.5V	$V_{CC}/2$
$V_{mo}$	1.5V	1.5V	$V_{CC}/2$
$V_x$	$V_{OL} + 0.3V$	$V_{OL} + 0.3V$	$V_{OL} + 0.15V$
$V_y$	$V_{OH} - 0.3V$	$V_{OH} - 0.3V$	$V_{OH} - 0.15V$

**Schematic Diagram** Generic for LCX Family



74LCXH32245

### Physical Dimensions inches (millimeters) unless otherwise noted

**Top View**

**Bottom View**

**Notes:**

- A. THIS PACKAGE CONFORMS TO JEDEC MO-205
- B. ALL DIMENSIONS IN MILLIMETERS
- C. LAND PATTERN RECOMMENDATION: NSMD (Non Solder Mask Defined)  
 .35MM DIA PADS WITH A SOLDERMASK OPENING OF .45MM CONCENTRIC TO PADS
- D. DRAWING CONFORMS TO ASME Y14.5M-1994

BGA96ArevE

**96-Ball Fine-Pitch Ball Grid Array (FBGA), JEDEC MO-205, 5.5mm Wide  
 Package Number BGA96A**

Fairchild does not assume any responsibility for use of any circuitry described, no circuit patent licenses are implied and Fairchild reserves the right at any time without notice to change said circuitry and specifications.

---

**LIFE SUPPORT POLICY**

FAIRCHILD'S PRODUCTS ARE NOT AUTHORIZED FOR USE AS CRITICAL COMPONENTS IN LIFE SUPPORT DEVICES OR SYSTEMS WITHOUT THE EXPRESS WRITTEN APPROVAL OF THE PRESIDENT OF FAIRCHILD SEMICONDUCTOR CORPORATION. As used herein:

1. Life support devices or systems are devices or systems which, (a) are intended for surgical implant into the body, or (b) support or sustain life, and (c) whose failure to perform when properly used in accordance with instructions for use provided in the labeling, can be reasonably expected to result in a significant injury to the user.
2. A critical component in any component of a life support device or system whose failure to perform can be reasonably expected to cause the failure of the life support device or system, or to affect its safety or effectiveness.

[www.fairchildsemi.com](http://www.fairchildsemi.com)