

18FF-2Z-C8

RELAY SOCKET



CHARACTERISTICS

Ambient temperature :	-40 °C to 70°C
Rated voltage:	300VAC
Rated current :	12A (per pole)
Insulation voltage (Min.) :	5000VAC
Protection degree DIN40050 :	IP20
Socket material :	PA66+GF V0 (UL)
Contacts spring material :	QSn6.5-0.1
Plastic retainer :	available
White plastic tag :	available
Modules (on request) :	HFAA to HFHU module available
Terminal torque :	0.6Nm
Wire strip length :	7mm
Applicable relay type:	HF18FF (JZX-18FF) (2 poles)

DIMENSIONS, PC BOARD LAYOUT AND WIRING DIAGRAM

Unit: mm

Outline Dimensions

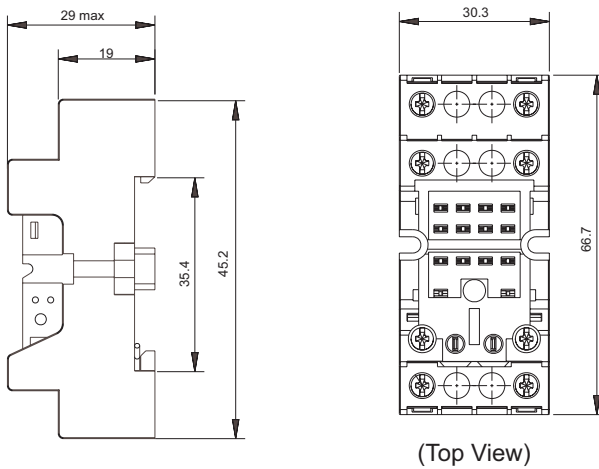

Wiring Diagram

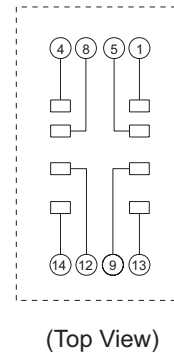

PCB Layout

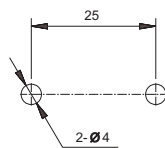

Retainer Dimensions

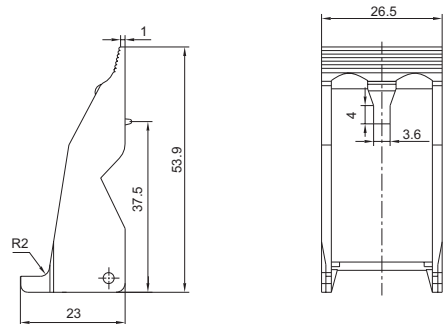

HONGFA RELAY

ISO9001、ISO/TS16949、ISO14001、OHSAS18001 CERTIFIED

2007 Rev. 1.00