



**Advanced Power  
Electronics Corp.**

**AP4880GM**

**Pb Free Plating Product**

*N-CHANNEL ENHANCEMENT MODE*

*POWER MOSFET*

- ▼ Low On-Resistance
- ▼ Fast Switching
- ▼ Simple Drive Requirement

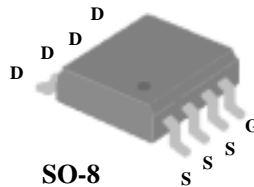

$BV_{DSS}$	25V
$R_{DS(ON)}$	8.5m $\Omega$
$I_D$	13A

## Description

The Advanced Power MOSFETs from APEC provide the designer with the best combination of fast switching, ruggedized device design, low on-resistance and cost-effectiveness.

The SO-8 package is universally preferred for all commercial-industrial surface mount applications and suited for low voltage applications such as DC/DC converters.

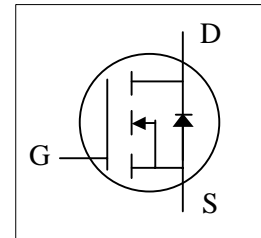

## Absolute Maximum Ratings

Symbol	Parameter	Rating	Units
$V_{DS}$	Drain-Source Voltage	25	V
$V_{GS}$	Gate-Source Voltage	$\pm 20$	V
$I_D@T_A=25^\circ C$	Continuous Drain Current <sup>3</sup>	13	A
$I_D@T_A=70^\circ C$	Continuous Drain Current <sup>3</sup>	10	A
$I_{DM}$	Pulsed Drain Current <sup>1</sup>	50	A
$P_D@T_A=25^\circ C$	Total Power Dissipation	2.5	W
	Linear Derating Factor	0.02	W/ $^\circ C$
$T_{STG}$	Storage Temperature Range	-55 to 150	$^\circ C$
$T_J$	Operating Junction Temperature Range	-55 to 150	$^\circ C$

## Thermal Data

Symbol	Parameter	Value	Unit
Rthj-amb	Thermal Resistance Junction-ambient <sup>3</sup>	Max. 50	$^\circ C/W$



## Electrical Characteristics @ $T_j=25^{\circ}\text{C}$ (unless otherwise specified)

Symbol	Parameter	Test Conditions	Min.	Typ.	Max.	Units
$BV_{DSS}$	Drain-Source Breakdown Voltage	$V_{GS}=0V, I_D=250\mu A$	25	-	-	V
$\Delta BV_{DSS}/\Delta T_j$	Breakdown Voltage Temperature Coefficient	Reference to $25^{\circ}\text{C}$ , $I_D=1\text{mA}$	-	0.037	-	$V/^{\circ}\text{C}$
$R_{DS(ON)}$	Static Drain-Source On-Resistance <sup>2</sup>	$V_{GS}=10V, I_D=13A$	-	-	8.5	$m\Omega$
		$V_{GS}=4.5V, I_D=10A$	-	-	15	$m\Omega$
$V_{GS(th)}$	Gate Threshold Voltage	$V_{DS}=V_{GS}, I_D=250\mu A$	1	-	3	V
$g_{fs}$	Forward Transconductance	$V_{DS}=15V, I_D=10A$	-	20	-	S
$I_{DSS}$	Drain-Source Leakage Current ( $T=25^{\circ}\text{C}$ )	$V_{DS}=25V, V_{GS}=0V$	-	-	1	$\mu A$
	Drain-Source Leakage Current ( $T=70^{\circ}\text{C}$ )	$V_{DS}=20V, V_{GS}=0V$	-	-	25	$\mu A$
$I_{GSS}$	Gate-Source Leakage	$V_{GS}=\pm 20V$	-	-	$\pm 100$	nA
$Q_g$	Total Gate Charge <sup>2</sup>	$I_D=13A$	-	22.5	-	nC
$Q_{gs}$	Gate-Source Charge	$V_{DS}=15V$	-	3.3	-	nC
$Q_{gd}$	Gate-Drain ("Miller") Charge	$V_{GS}=5V$	-	15.4	-	nC
$t_{d(on)}$	Turn-on Delay Time <sup>2</sup>	$V_{DS}=15V$	-	9	-	ns
$t_r$	Rise Time	$I_D=1A$	-	16	-	ns
$t_{d(off)}$	Turn-off Delay Time	$R_G=6.2\Omega, V_{GS}=10V$	-	25	-	ns
$t_f$	Fall Time	$R_D=15\Omega$	-	50	-	ns
$C_{iss}$	Input Capacitance	$V_{GS}=0V$	-	813	-	pF
$C_{oss}$	Output Capacitance	$V_{DS}=25V$	-	516	-	pF
$C_{riss}$	Reverse Transfer Capacitance	$f=1.0\text{MHz}$	-	224	-	pF

## Source-Drain Diode

Symbol	Parameter	Test Conditions	Min.	Typ.	Max.	Units
$I_S$	Continuous Source Current ( Body Diode )	$V_D=V_G=0V, V_S=1.3V$	-	-	1.92	A
$V_{SD}$	Forward On Voltage <sup>2</sup>	$T_j=25^{\circ}\text{C}, I_S=2.3A, V_{GS}=0V$	-	-	1.3	V

### Notes:

1. Pulse width limited by Max. junction temperature.
2. Pulse width  $\leq 300\mu s$ , duty cycle  $\leq 2\%$ .
3. Surface mounted on  $1\text{ in}^2$  copper pad of FR4 board ;  $125^{\circ}\text{C/W}$  when mounted on Min. copper pad.

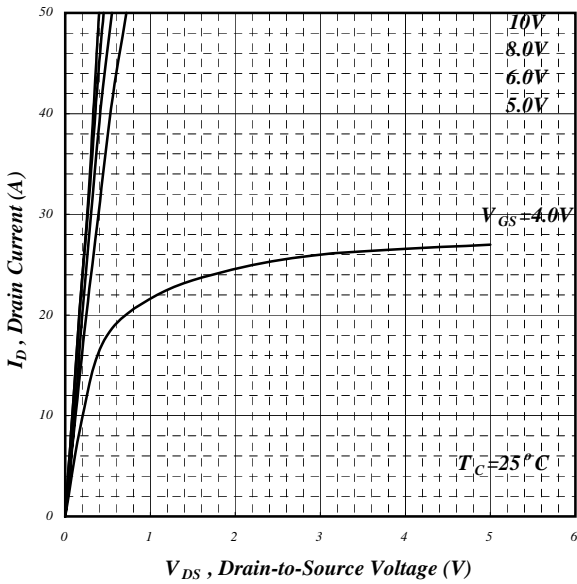

Fig 1. Typical Output Characteristics

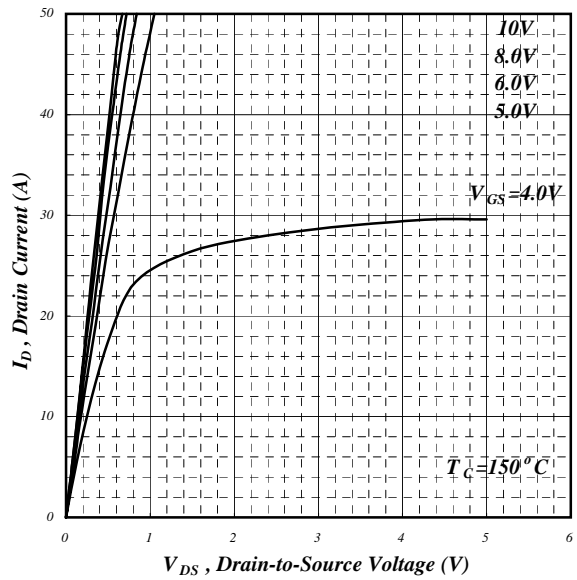

Fig 2. Typical Output Characteristics

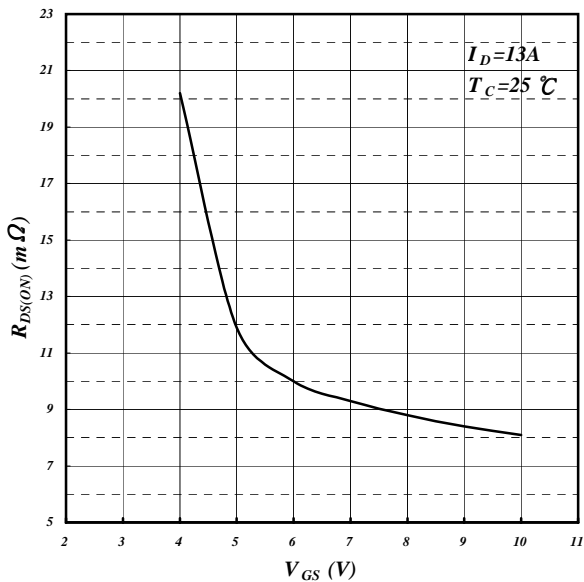

Fig 3. On-Resistance v.s. Gate Voltage

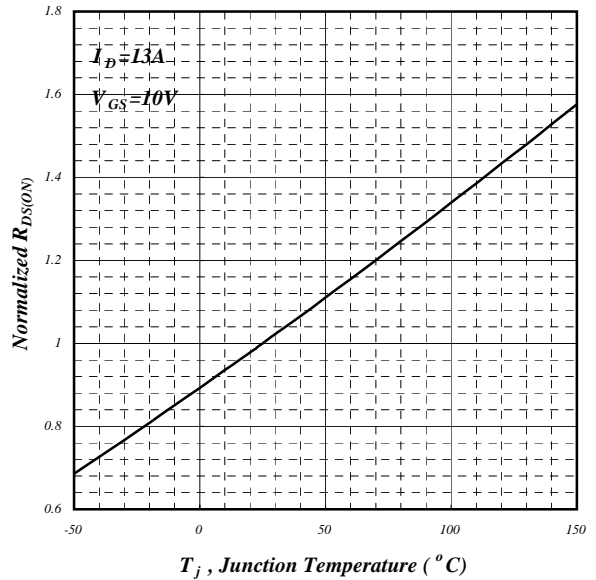

Fig 4. Normalized On-Resistance v.s. Junction Temperature

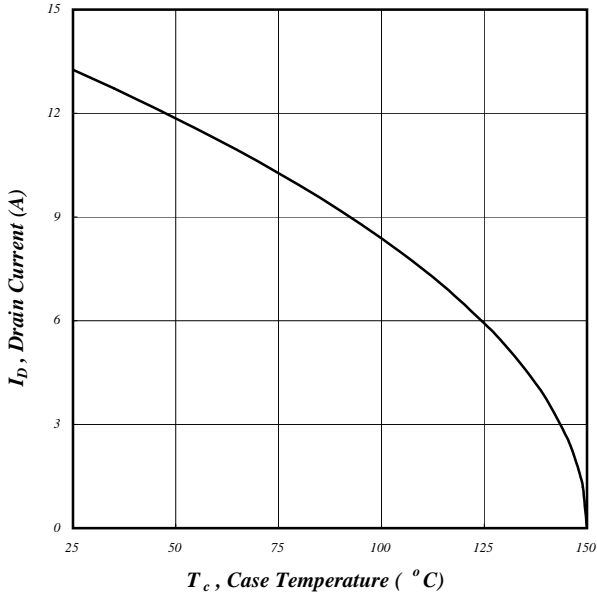

Fig 5. Maximum Drain Current v.s. Case Temperature

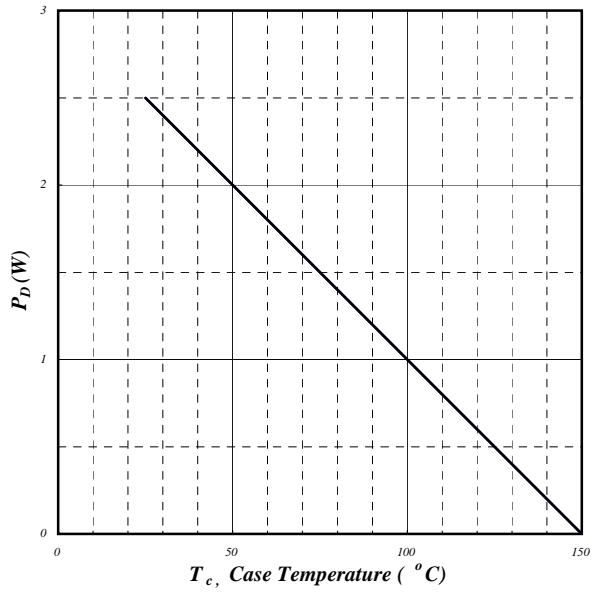

Fig 6. Typical Power Dissipation

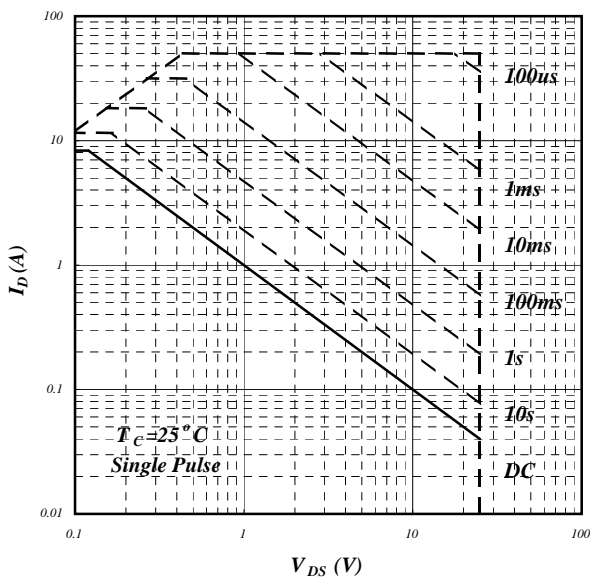

Fig 7. Maximum Safe Operating Area

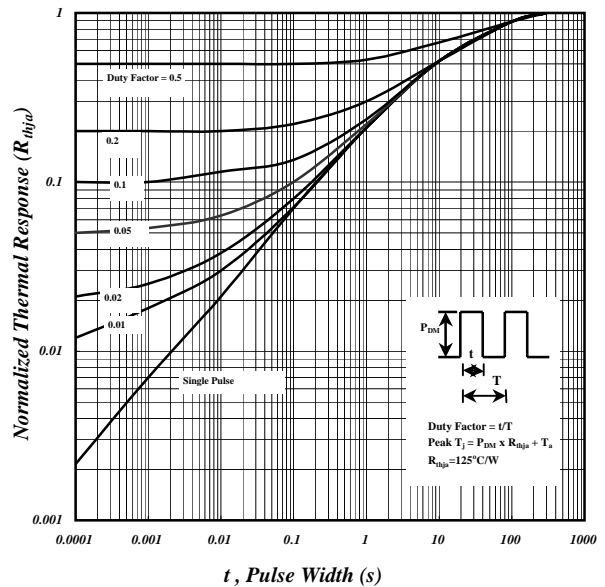

Fig 8. Effective Transient Thermal Impedance

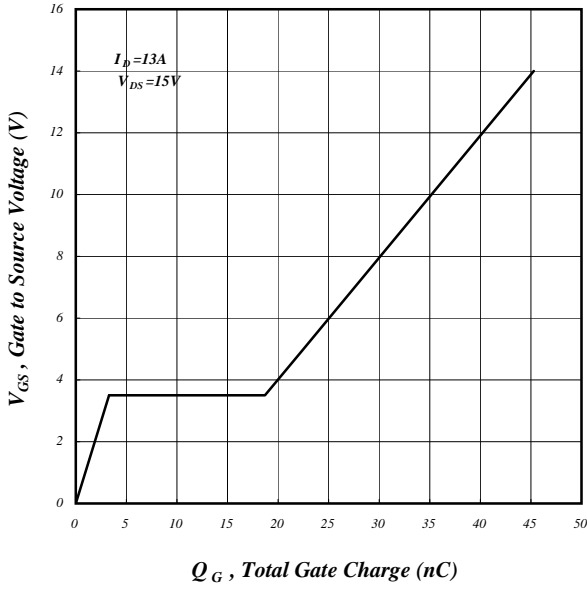

Fig 9. Gate Charge Characteristics

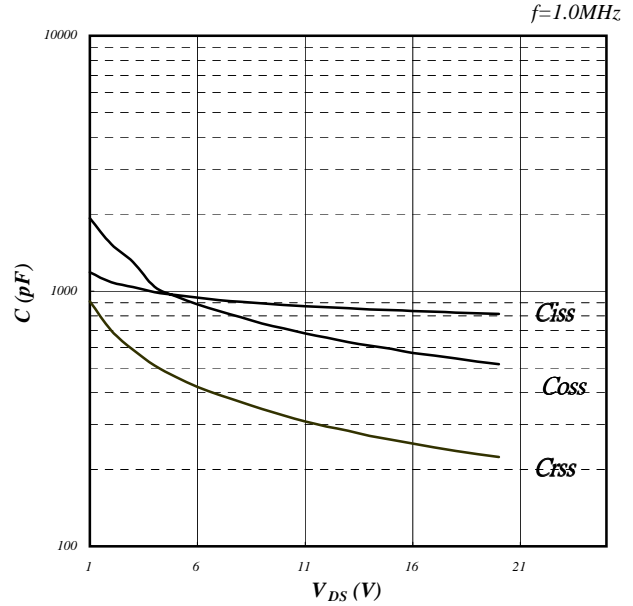

Fig 10. Typical Capacitance Characteristics

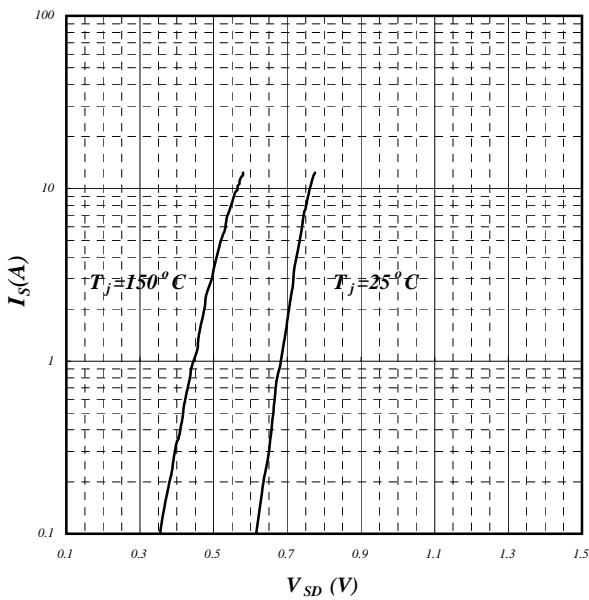

Fig 11. Forward Characteristic of Reverse Diode

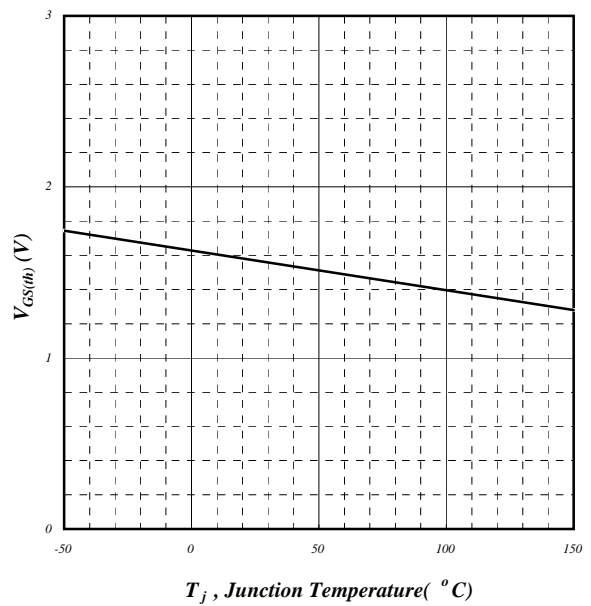

Fig 12. Gate Threshold Voltage v.s. Junction Temperature

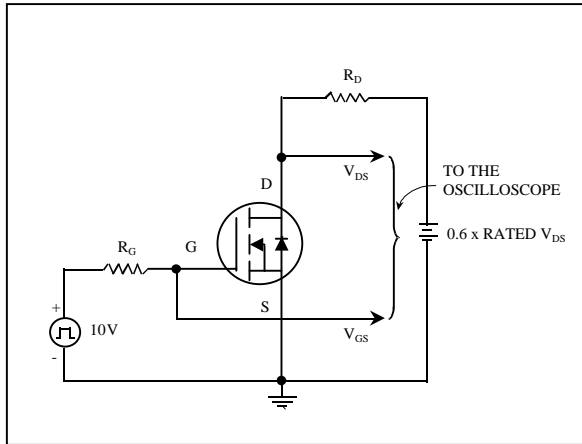

Fig 13. Switching Time Circuit

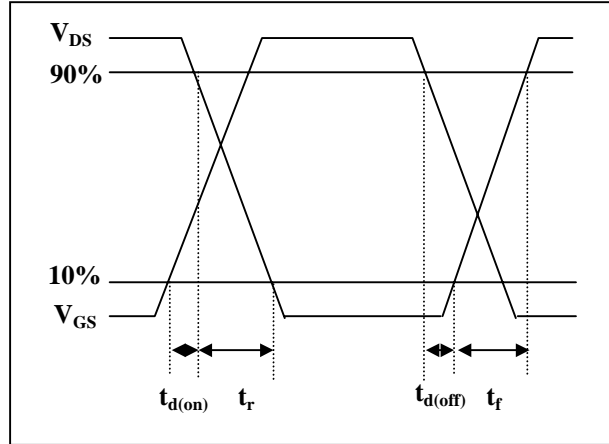

Fig 14. Switching Time Waveform

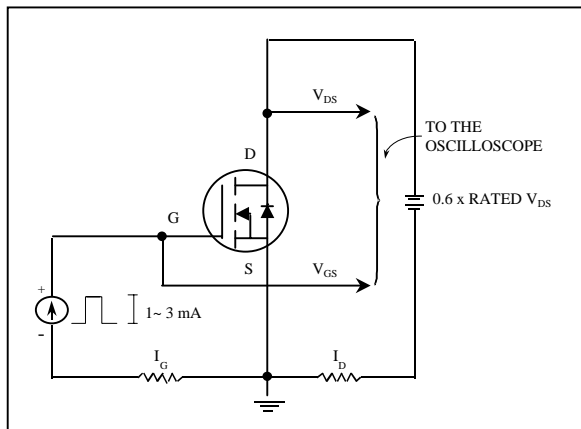

Fig 15. Gate Charge Circuit

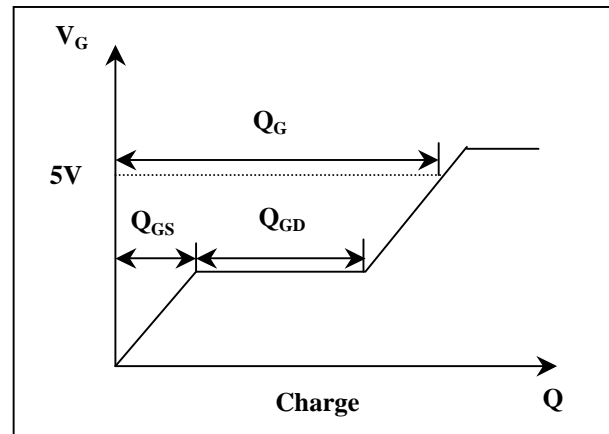

Fig 16. Gate Charge Waveform