



CED3070/CEU3070

N-Channel Enhancement Mode Field Effect Transistor

FEATURES

- 30V, 62A, $R_{DS(ON)} = 9.5m\Omega$ @ $V_{GS} = 10V$.
 $R_{DS(ON)} = 13.5m\Omega$ @ $V_{GS} = 4.5V$.
- Super high dense cell design for extremely low $R_{DS(ON)}$.
- High power and current handling capability.
- Lead free product is acquired.
- TO-251 & TO-252 package.

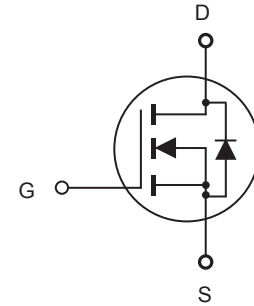

ABSOLUTE MAXIMUM RATINGS $T_C = 25^\circ C$ unless otherwise noted

| Parameter | Symbol | Limit | Units |
|---|----------------|------------|---------------|
| Drain-Source Voltage | V_{DS} | 30 | V |
| Gate-Source Voltage | V_{GS} | ± 20 | V |
| Drain Current-Continuous | I_D | 62 | A |
| Drain Current-Pulsed ^a | I_{DM} | 240 | A |
| Maximum Power Dissipation @ $T_C = 25^\circ C$ - Derate above $25^\circ C$ | P_D | 60 | W |
| | | 0.48 | W/ $^\circ C$ |
| Operating and Store Temperature Range | T_J, T_{stg} | -55 to 150 | $^\circ C$ |

Thermal Characteristics

| Parameter | Symbol | Limit | Units |
|---|-----------------|-------|--------------|
| Thermal Resistance, Junction-to-Case | $R_{\theta JC}$ | 2.1 | $^\circ C/W$ |
| Thermal Resistance, Junction-to-Ambient | $R_{\theta JA}$ | 50 | $^\circ C/W$ |



CED3070/CEU3070

Electrical Characteristics $T_C = 25^\circ\text{C}$ unless otherwise noted

| Parameter | Symbol | Test Condition | Min | Typ | Max | Units |
|--|--------------|---|-----|------|------|-----------|
| Off Characteristics | | | | | | |
| Drain-Source Breakdown Voltage | BV_{DSS} | $V_{GS} = 0V, I_D = 250\mu A$ | 30 | | | V |
| Zero Gate Voltage Drain Current | I_{DSS} | $V_{DS} = 30V, V_{GS} = 0V$ | | | 1 | μA |
| Gate Body Leakage Current, Forward | I_{GSSF} | $V_{GS} = 20V, V_{DS} = 0V$ | | | 100 | nA |
| Gate Body Leakage Current, Reverse | I_{GSSR} | $V_{GS} = -20V, V_{DS} = 0V$ | | | -100 | nA |
| On Characteristics^b | | | | | | |
| Gate Threshold Voltage | $V_{GS(th)}$ | $V_{GS} = V_{DS}, I_D = 250\mu A$ | 1 | | 3 | V |
| Static Drain-Source On-Resistance | $R_{DS(on)}$ | $V_{GS} = 10V, I_D = 30A$ | | 7.8 | 9.5 | $m\Omega$ |
| | | $V_{GS} = 4.5V, I_D = 24A$ | | 10.5 | 13.5 | $m\Omega$ |
| Forward Transconductance | g_{FS} | $V_{DS} = 10V, I_D = 30A$ | | 23 | | S |
| Dynamic Characteristics^c | | | | | | |
| Input Capacitance | C_{iss} | $V_{DS} = 15V, V_{GS} = 0V, f = 1.0\text{ MHz}$ | | 2110 | | pF |
| Output Capacitance | C_{oss} | | | 400 | | pF |
| Reverse Transfer Capacitance | C_{rss} | | | 250 | | pF |
| Switching Characteristics^c | | | | | | |
| Turn-On Delay Time | $t_{d(on)}$ | $V_{DD} = 15V, I_D = 45A, V_{GS} = 10V, R_{GEN} = 24\Omega$ | | 16 | 32 | ns |
| Turn-On Rise Time | t_r | | | 21 | 42 | ns |
| Turn-Off Delay Time | $t_{d(off)}$ | | | 151 | 260 | ns |
| Turn-Off Fall Time | t_f | | | 74 | 148 | ns |
| Total Gate Charge | Q_g | $V_{DS} = 15V, I_D = 45A, V_{GS} = 10V$ | | 33.2 | 45.6 | nC |
| Gate-Source Charge | Q_{gs} | | | 5.2 | | nC |
| Gate-Drain Charge | Q_{gd} | | | 8.7 | | nC |
| Drain-Source Diode Characteristics and Maximum Ratings | | | | | | |
| Drain-Source Diode Forward Current | I_S | | | | 30 | A |
| Drain-Source Diode Forward Voltage ^b | V_{SD} | $V_{GS} = 0V, I_S = 30A$ | | | 1.2 | V |
| Notes : □ a.Repetitive Rating : Pulse width limited by maximum junction temperature. b.Pulse Test : Pulse Width $\leq 300\mu s$, Duty Cycle $\leq 2\%$. □ c.Guaranteed by design, not subject to production testing. □ | | | | | | |



CED3070/CEU3070

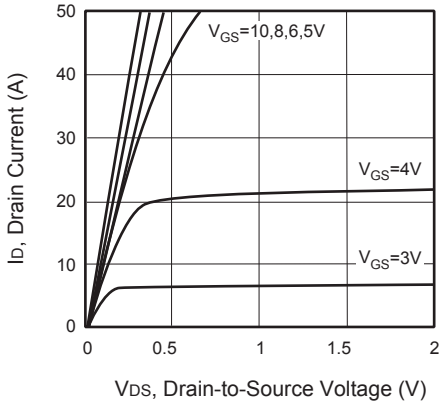

Figure 1. Output Characteristics

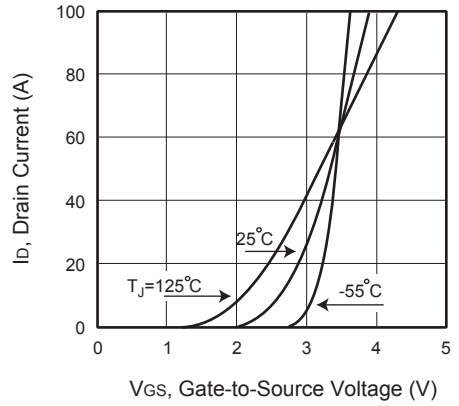

Figure 2. Transfer Characteristics

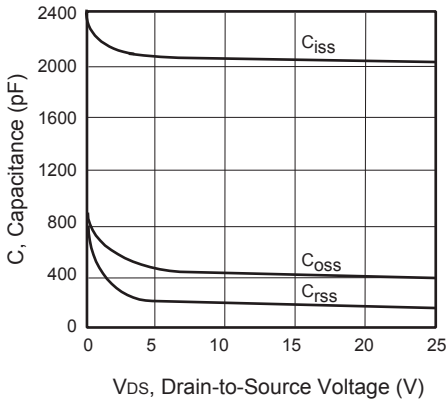

Figure 3. Capacitance

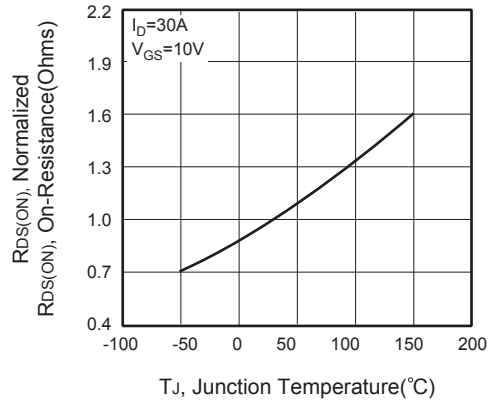

Figure 4. On-Resistance Variation with Temperature



Figure 5. Gate Threshold Variation with Temperature

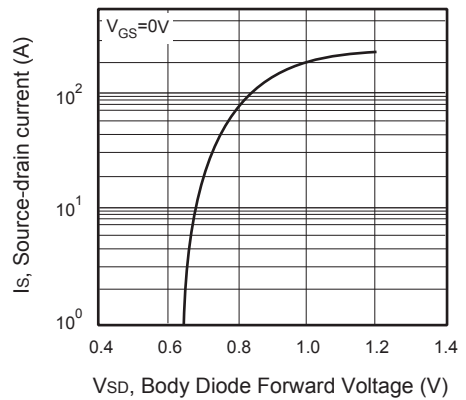

Figure 6. Body Diode Forward Voltage Variation with Source Current



CED3070/CEU3070

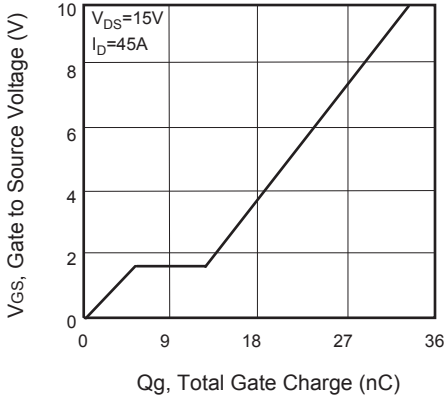

Figure 7. Gate Charge

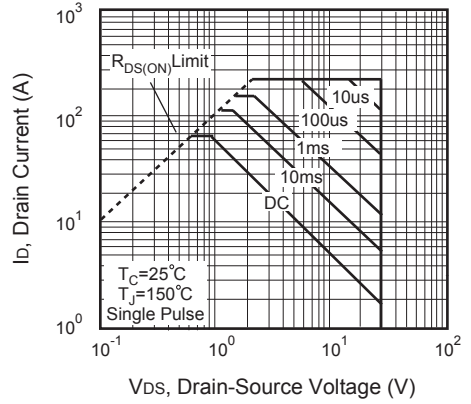

Figure 8. Maximum Safe Operating Area

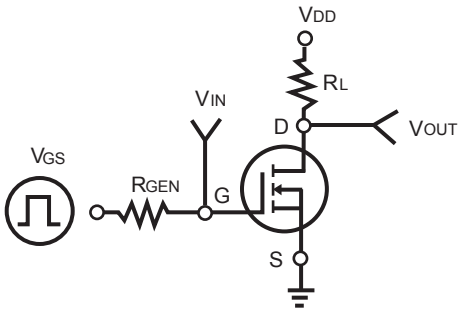

Figure 9. Switching Test Circuit

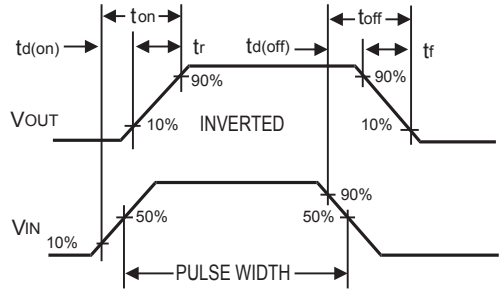

Figure 10. Switching Waveforms

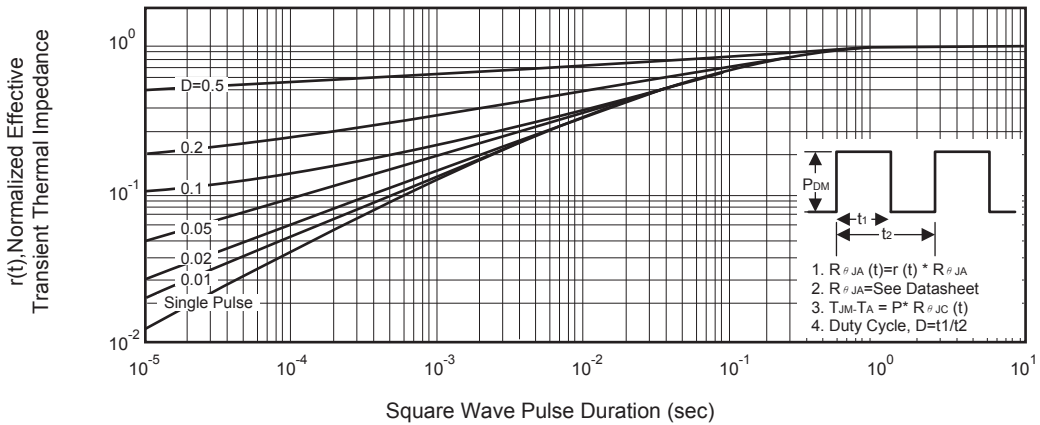

Figure 11. Normalized Thermal Transient Impedance Curve