

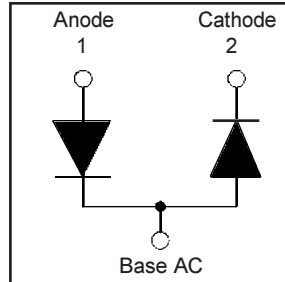
# HFA160NJ40D

HEXFRED™

Ultrafast, Soft Recovery Diode

## Features

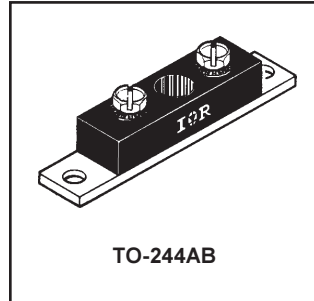
- Reduced RFI and EMI
- Reduced Snubbing
- Extensive Characterization of Recovery Parameters



$V_R = 400V$
$V_F(\text{typ.})^{\textcircled{3}} = 1V$
$I_{F(AV)} = 160A$
$Q_{rr}(\text{typ.}) = 420nC$
$I_{RRM}(\text{typ.}) = 9.3A$
$t_{rr}(\text{typ.}) = 36ns$
$di_{(rec)M}/dt(\text{typ.})^{\textcircled{3}} = 260A/\mu s$

## Description

HEXFRED™ diodes are optimized to reduce losses and EMI/RFI in high frequency power conditioning systems. An extensive characterization of the recovery behavior for different values of current, temperature and di/dt simplifies the calculations of losses in the operating conditions. The softness of the recovery eliminates the need for a snubber in most applications. These devices are ideally suited for power converters, motors drives and other applications where switching losses are significant portion of the total losses.



## Absolute Maximum Ratings (per Leg)

	Parameter	Max.	Units
$V_R$	Cathode-to-Anode Voltage	400	V
$I_F @ T_C = 25^\circ C$	Continuous Forward Current	170	A
$I_F @ T_C = 100^\circ C$	Continuous Forward Current	84	
$I_{FSM}$	Single Pulse Forward Current <sup>①</sup>	600	
$E_{AS}$	Non-Repetitive Avalanche Energy <sup>②</sup>	1.4	mJ
$P_D @ T_C = 25^\circ C$	Maximum Power Dissipation	310	W
$P_D @ T_C = 100^\circ C$	Maximum Power Dissipation	125	
$T_J$	Operating Junction and	-55 to +150	C
$T_{STG}$	Storage Temperature Range		

## Thermal - Mechanical Characteristics

	Parameter	Min.	Typ.	Max.	Units
$R_{thJC}$	Junction-to-Case, Single Leg Conducting	—	—	0.48	°C/W K/W
	Junction-to-Case, Both Legs Conducting	—	—	0.24	
$R_{thCS}$	Case-to-Sink, Flat, Greased Surface	—	0.10	—	
$Wt$	Weight	—	79 (2.8)	—	g (oz)
	Mounting Torque <sup>④</sup>	30 (3.4)	—	40 (4.6)	lbf·in (N·m)
	Mounting Torque Center Hole	12 (1.4)	—	18 (2.1)	
	Terminal Torque	30 (3.4)	—	40 (4.6)	
	Vertical Pull	—	—	80	lbf·in
2 inch Lever Pull	—	—	35		

**Note:** <sup>①</sup> Limited by junction temperature  
<sup>②</sup> L = 100μH, duty cycle limited by max  $T_J$   
<sup>③</sup> 125°C

<sup>④</sup> Mounting surface must be smooth, flat, free of burrs or other protrusions. Apply a thin even film of thermal grease to mounting surface. Gradually tighten each mounting bolt in 5-10 lbf·in steps until desired or maximum torque limits are reached. Module

# HFA160NJ40D

PD-2.511 rev. A 02/99

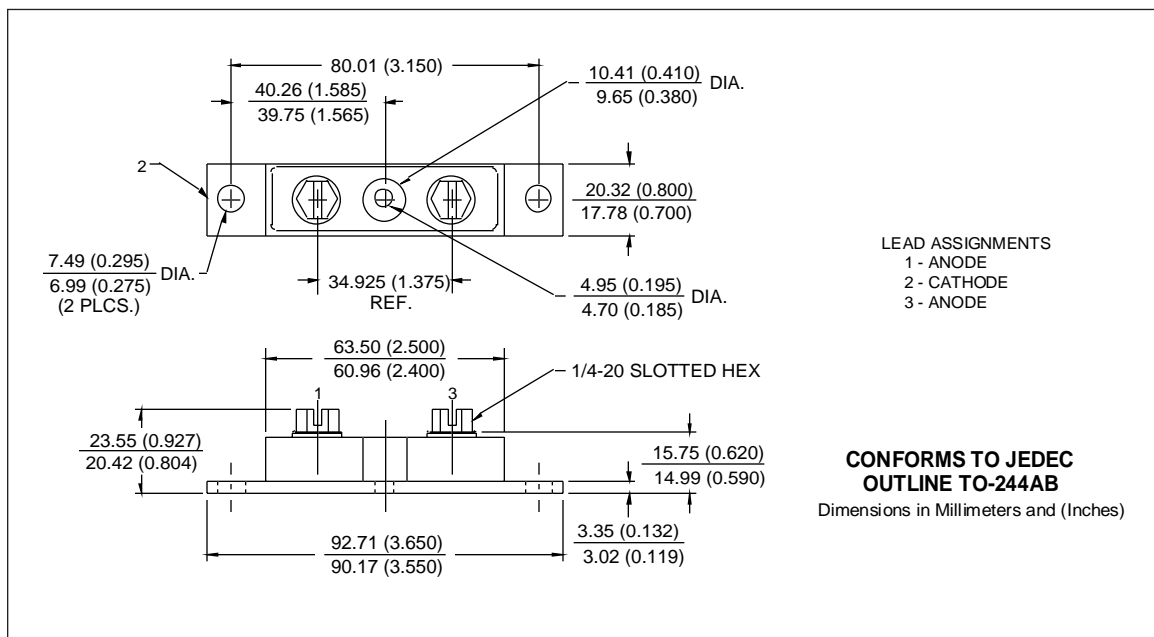
International  
**IOR** Rectifier

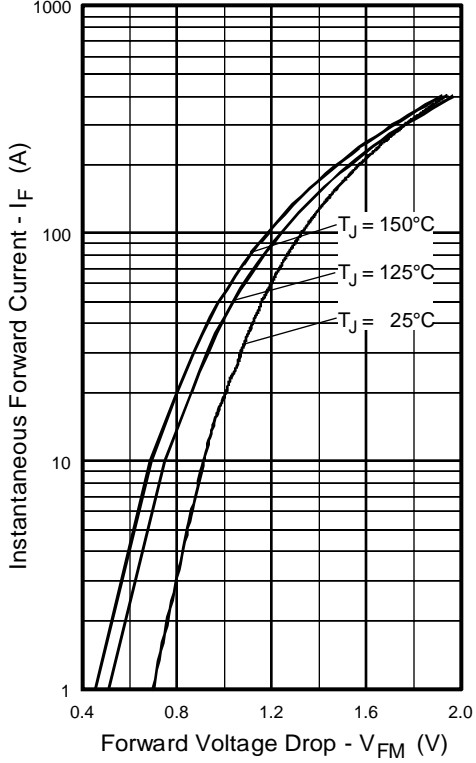
## Electrical Characteristics (per Leg) @ $T_J = 25^\circ\text{C}$ (unless otherwise specified)

Parameter	Min.	Typ.	Max.	Units	Test Conditions
$V_{BR}$ Cathode Anode Breakdown Voltage	400	—	—	V	$I_R = 100\mu\text{A}$
$V_{FM}$ Max Forward Voltage	—	1.1	1.3	V	$I_F = 80\text{A}$ $I_F = 160\text{A}$ See Fig. 1 $I_F = 80\text{A}, T_J = 125^\circ\text{C}$
	—	1.3	1.5		
	—	1.0	1.2		
$I_{RM}$ Max Reverse Leakage Current	—	1.0	6.0	$\mu\text{A}$	$V_R = V_R$ Rated See Fig. 2 $T_J = 125^\circ\text{C}, V_R = 320\text{V}$
	—	1.5	8.0	$\text{mA}$	
$C_T$ Junction Capacitance	—	180	260	$\text{pF}$	$V_R = 200\text{V}$ See Fig. 3
$L_S$ Series Inductance	—	7.0	—	$\text{nH}$	From top of terminal hole to mounting plane

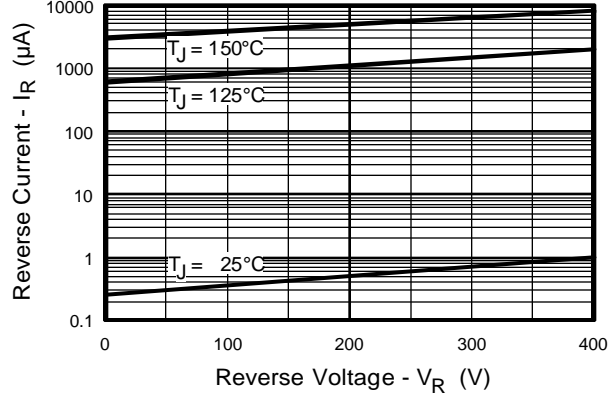
## Dynamic Recovery Characteristics (per Leg) @ $T_J = 25^\circ\text{C}$ (unless otherwise specified)

Parameter	Min.	Typ.	Max.	Units	Test Conditions
$t_{rr}$ Reverse Recovery Time	—	36	—	ns	$I_F = 1.0\text{A}, di_f/dt = 200\text{A}/\mu\text{s}, V_R = 30\text{V}$ $T_J = 25^\circ\text{C}$ See Fig. 5 $T_J = 125^\circ\text{C}$
$t_{rr1}$	—	90	140		
$t_{rr2}$	—	160	240		
$I_{RRM1}$ Peak Recovery Current	—	9.3	17	A	$T_J = 25^\circ\text{C}$ See Fig. 6 $T_J = 125^\circ\text{C}$
	$I_{RRM2}$	—	15		
$Q_{rr1}$ Reverse Recovery Charge	—	420	1100	nC	$T_J = 25^\circ\text{C}$ See Fig. 7 $T_J = 125^\circ\text{C}$
	$Q_{rr2}$	—	1200		
$di_{(rec)M}/dt1$ Peak Rate of Fall of Recovery Current	—	360	—	$\text{A}/\mu\text{s}$	$T_J = 25^\circ\text{C}$ See Fig. 8 $T_J = 125^\circ\text{C}$
$di_{(rec)M}/dt2$ During $t_b$	—	260	—		

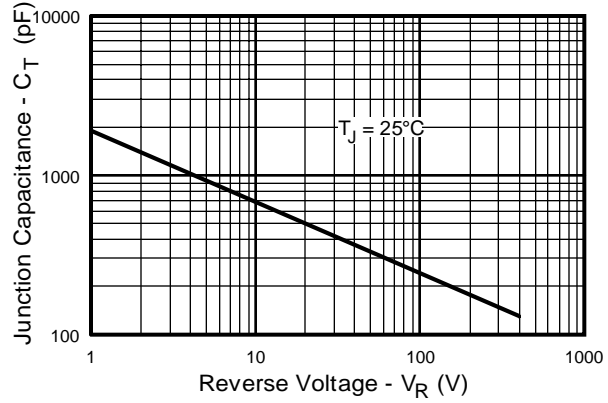




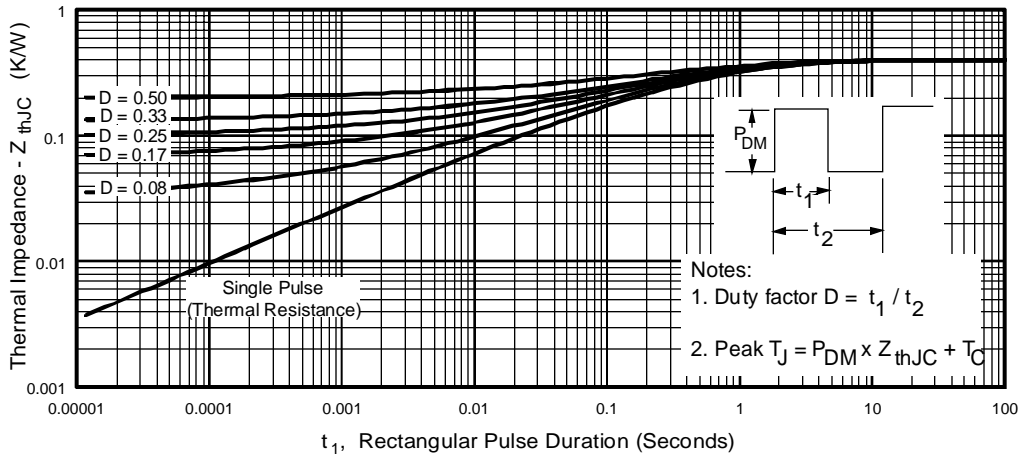
**Fig. 1** - Maximum Forward Voltage Drop vs. Instantaneous Forward Current, (per Leg)



**Fig. 2** - Typical Reverse Current vs. Reverse Voltage, (per Leg)



**Fig. 3** - Typical Junction Capacitance vs. Reverse Voltage, (per Leg)

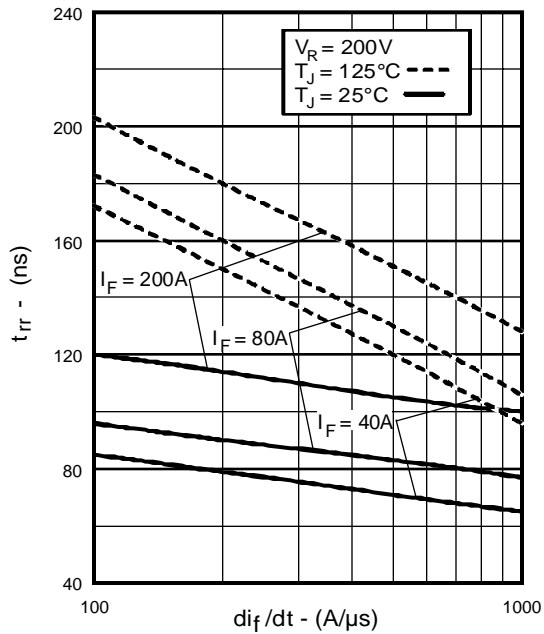


**Fig. 4** - Maximum Thermal Impedance  $Z_{thJC}$  Characteristics, (per Leg)

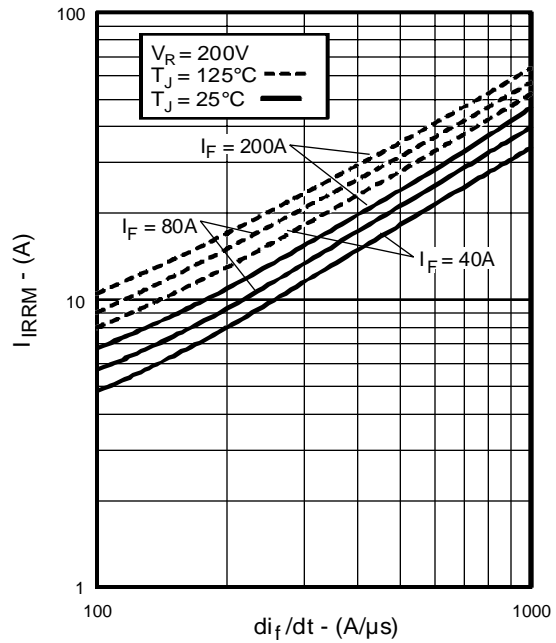
# HFA160NJ40D

PD-2.511 rev. A 02/99

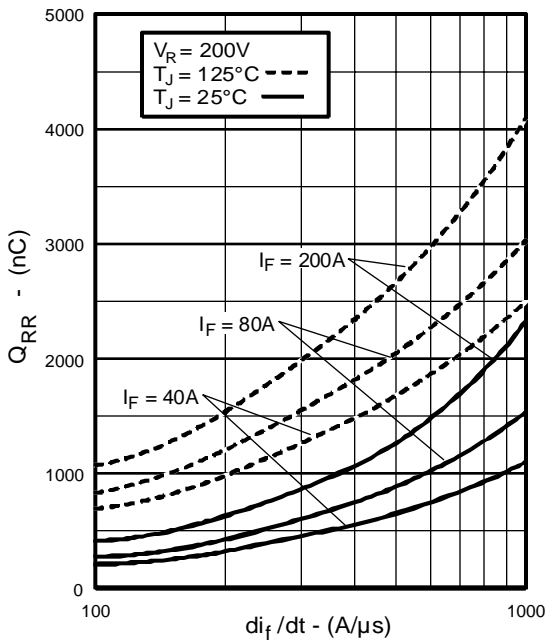
International  
IOR Rectifier



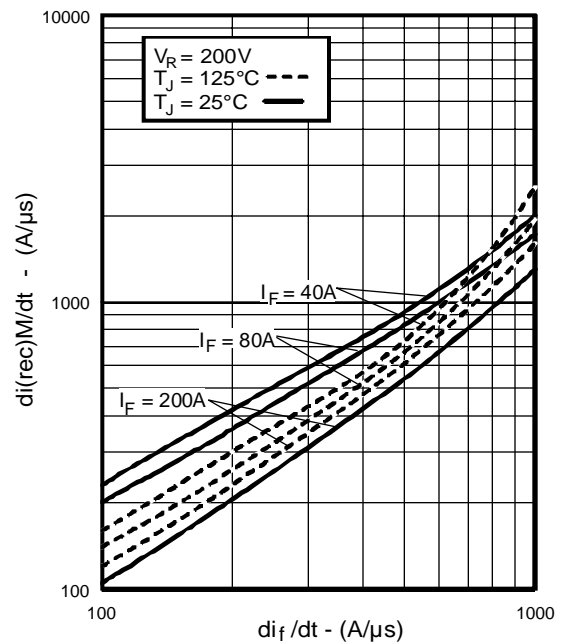
**Fig. 5 - Typical Reverse Recovery vs.  $di_f/dt$ , (per Leg)**



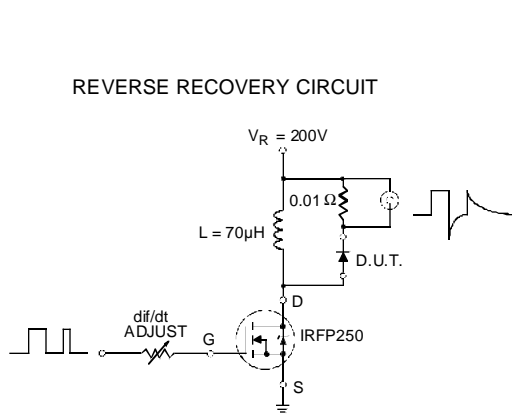
**Fig. 6 - Typical Recovery Current vs.  $di_f/dt$ , (per Leg)**



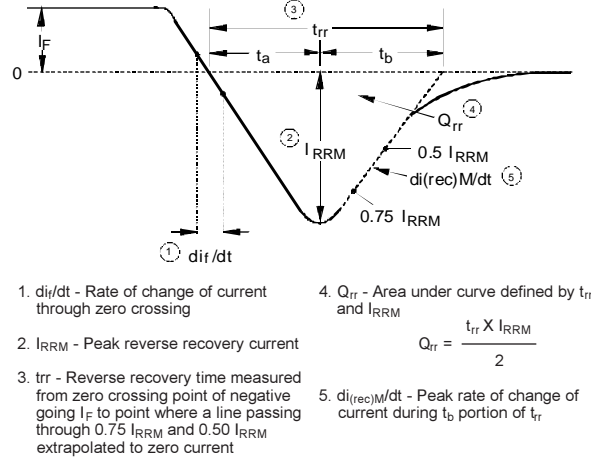
**Fig. 7 - Typical Stored Charge vs.  $di_f/dt$ , (per Leg)**



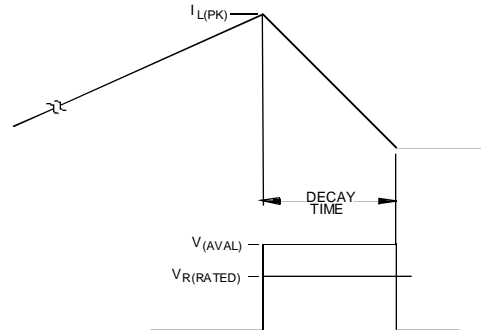
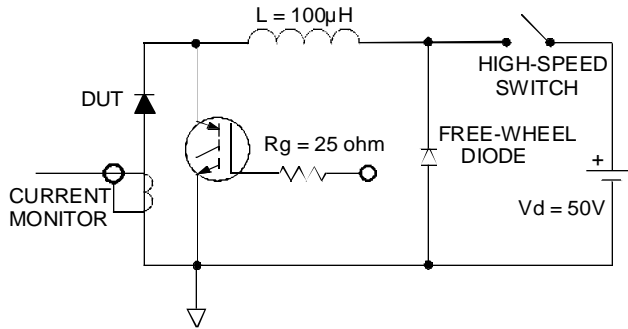
**Fig. 8 - Typical  $di_{(rec)M}/dt$  vs.  $di_f/dt$ , (per Leg)**



**Fig. 9 - Reverse Recovery Parameter Test Circuit**



**Fig. 10 - Reverse Recovery Waveform and Definitions**



**Fig. 11 - Avalanche Test Circuit and Waveforms**