

# STEWART CONNECTOR SYSTEMS, INC.

R.D. 2, BOX 2020 GLEN ROCK, PENNSYLVANIA 17327

THIS DRAWING AND THE SUBJECT MATTER SHOWN THEREON ARE CONFIDENTIAL AND THE PROPRIETARY PROPERTY OF STEWART CONNECTOR SYSTEMS ("SCS") AND SHALL NOT BE REPRODUCED, COPIED OR USED IN ANY MANNER WITHOUT PRIOR WRITTEN CONSENT OF "SCS". THE SUBJECT MATTER MAY BE PATENTED OR A PATENT MAY BE PENDING. © SCS

**FOR REFERENCE  
ONLY**

PART NO. SS-738844S-PG4-AE  
EIGHT CONTACT, EIGHT POSITION  
SHIELDED STACKED HARMONICA JACK  
8 PORTS (4 ON 4)

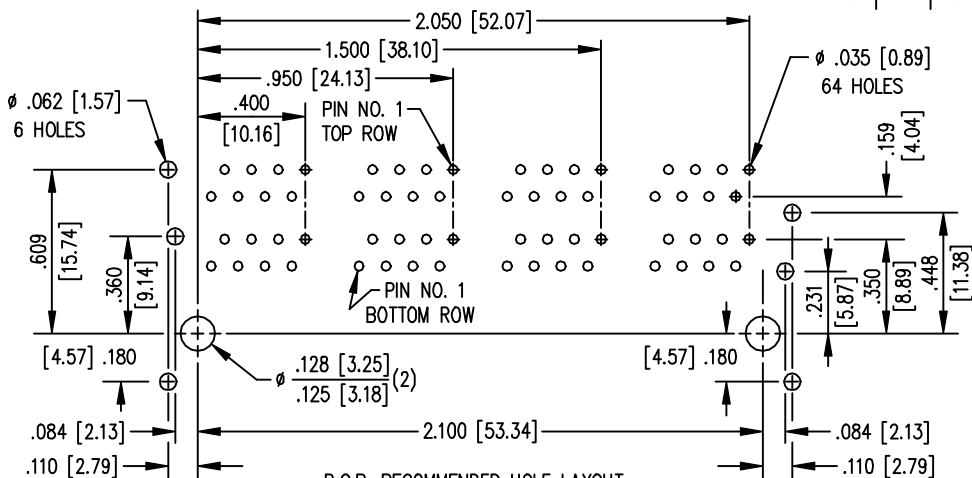
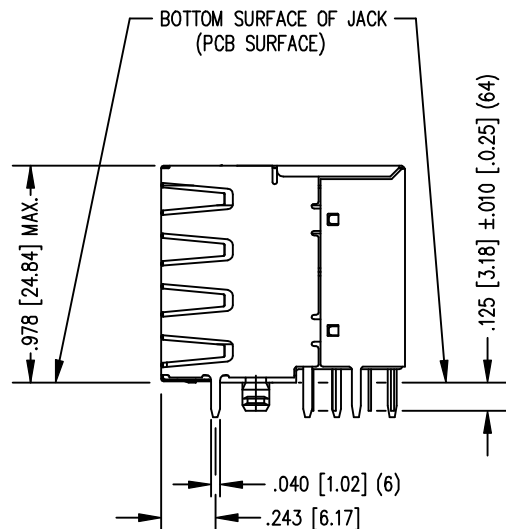
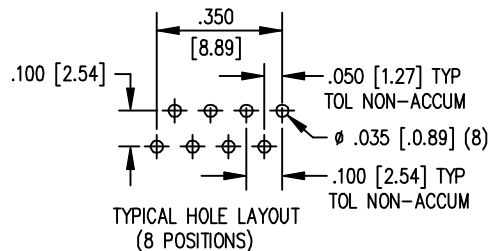
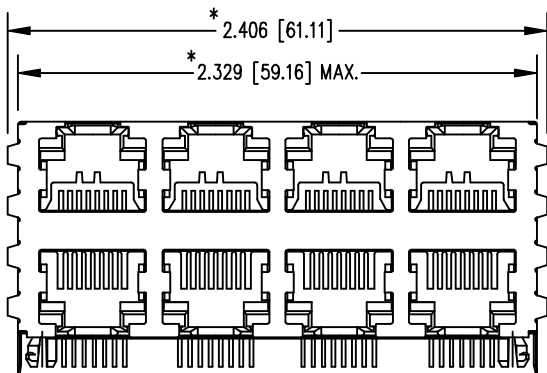
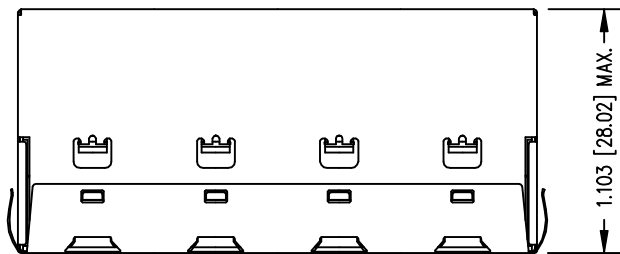

**NOTES:**

- TOLERANCES COMPLY WITH F.C.C. DIMENSION REQUIREMENTS.
- DIMENSIONS SHOWN WITH "\*" TO BE CENTRAL ABOUT THE CENTER LINE.
- DIMENSIONS SHOWN ARE SUBJECT TO CHANGE WITHOUT NOTICE.

**AVAILABLE WITH:**

- 30 OR 50 MICRO-INCH SELECTIVE GOLD PLATING
- LOADED 1 - 8 CONTACTS

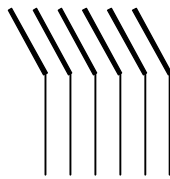

**STEWART  
CONNECTOR  
SYSTEMS, INC.**

R.D. 2, BOX 2020 GLEN ROCK, PENNSYLVANIA 17327

PART NO. SS-738844S-PG4-AE

THIS DRAWING AND THE SUBJECT MATTER SHOWN THEREON ARE CONFIDENTIAL AND THE PROPRIETARY PROPERTY OF STEWART CONNECTOR SYSTEMS ("SCS") AND SHALL NOT BE REPRODUCED, COPIED OR USED IN ANY MANNER WITHOUT PRIOR WRITTEN CONSENT OF "SCS". THE SUBJECT MATTER MAY BE PATENTED OR A PATENT MAY BE PENDING. © SCS

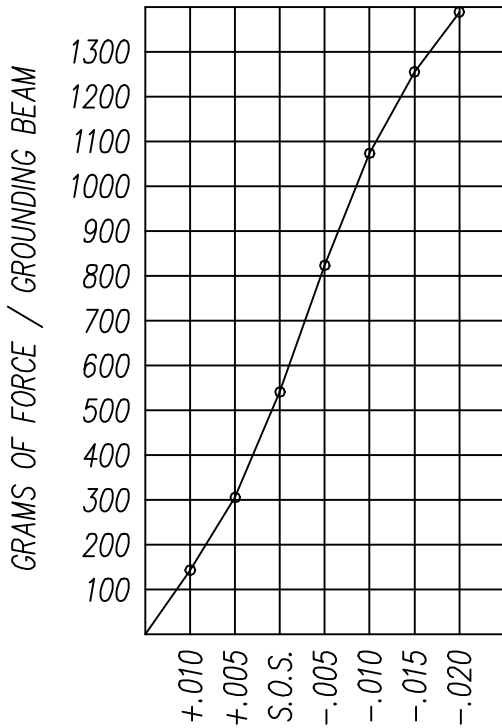

PANEL GROUNDING BEAM DEFLECTION  
SIDE BEAMS  
S.O.S. = SUGGESTED OPENING SIZE

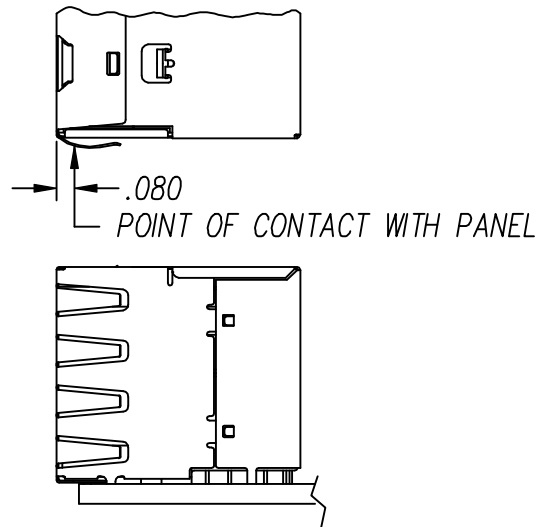

**FOR REFERENCE  
ONLY**

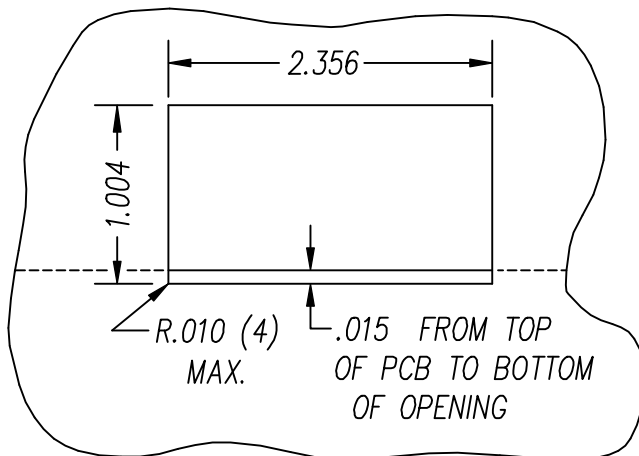

SUGGESTED PANEL OPENING  
(N.T.S.)

THE SUGGESTED PANEL OPENING IS INTENDED TO GIVE THE USER THE ABILITY TO HAVE REASONABLE JACK / PANEL CLEARANCES YET MAINTAIN RELIABLE GROUNDING CAPABILITY. THESE VARIABLES CAN BE ADJUSTED IN EITHER DIRECTION BUT MAY CARRY SOME CONSEQUENCES IN THE FORM OF LOWER MATING FORCES OR TIGHTER ASSEMBLY TOLERANCES. FORCE VALUES ON THE GRAPH(S) ARE GENERAL AVERAGES TAKEN AT A POINT OF CONTACT SHOWN ABOVE. THE SUGGESTED PANEL OPENING INCLUDES APPROXIMATELY .020 CLEARANCE ON THE SIDES.