

The RF Line Broadband R.F. Array for TV Transmitter

MRFA2604

**230 W PEAK SYNC.
470–860 MHz
CLASS AB
RF POWER AMPLIFIER**

The MRFA2604 is a solid state class AB amplifier specifically designed for TV transposers and transmitters. This amplifier incorporates microstrip technology and reliable Motorola push–pull transistors.

The MRFA2604 includes a thermal compensation (differential gain is constant versus average picture level (APL)) which can be partially disconnected.

- Specified 28 Volts, 470–860 MHz Characteristics
Output Power = 175 Watts (CW)/230 Watts (Video)
Minimum Gain = 8.0 dB (@ Nominal Power)
- 50 Ω Input and Output Impedance
- Class AB Operation
- Thermally Compensated

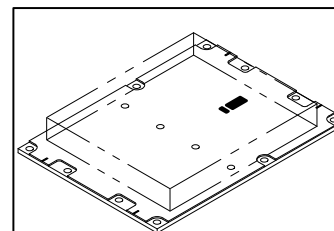

CASE 439-01, STYLE 1

MAXIMUM RATINGS

Rating	Symbol	Value	Unit
Supply Voltage	V_{CC}	32	Vdc
Current	I_{max}	15	Adc
Storage Temperature Range	T_{stg}	–40 to +100	°C
Operating Temperature (1)	T_{op}	–20 to +70	°C

NOMINAL OPERATION CONDITION

Supply Voltage/Quiescent Current (2)	$V_{CC} = 28\text{ V}$	$I_Q = 0.9\text{ A}$
--------------------------------------	------------------------	----------------------

ELECTRICAL CHARACTERISTICS IN CW ($T_C = 25^\circ\text{C}$, $V_{CC} = 28\text{ V}$, $I_Q = 0.5\text{ A}$, without thermal correction)

Characteristic	Symbol	Min	Typ	Max	Unit
Instantaneous Bandwidth	BW	470	—	860	MHz
Power Gain ($P_{out} = 175\text{ W}$)	G_p	8.0	9.0	—	dB
Gain Ripple ($P_{out} = 175\text{ W}$)	G_{rple}	—	± 0.5	± 1.0	dB
Output Power @ 1.0 dB Compression	P_{out}	175 (3)	190	—	W
Efficiency ($P_{out} = 175\text{ W}$)	η	45 (3)	50	—	%
Input Return Loss	I_{RL}	—	–20	–15	dB

ELECTRICAL CHARACTERISTICS IN VIDEO ($T_C = 25^\circ\text{C}$, $I_{sup} = 0.9\text{ A}$, with thermal compensation)

Characteristic	Symbol	Min	Typ	Max	Unit
Output Power @ 28 V (Peak Sync. B/G standard)	P_{out}	230	240	—	W
Power Gain @ black level ($P_{sync} = 230\text{ W}$, $V_{CC} = 28\text{ V}$)	G_p	8.0	9.0	—	dB

- (1) Temperature is measured at temperature test point (on the flange of the transistor).
- (2) Tuned in the factory for optimum thermal correction @ 25°C.
- (3) Thermal correction cannot be disconnected, and CW performances are slightly affected (–5.0 W, –3% typical), but output power with a video signal remain the same.

TYPICAL CHARACTERISTICS

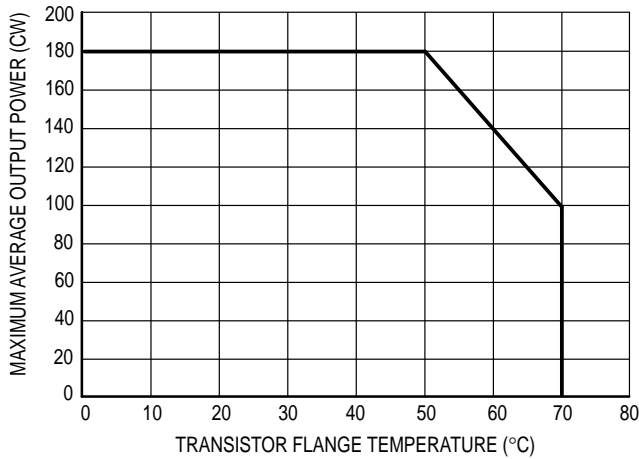

Figure 1. Maximum Average Output Power versus Temperature

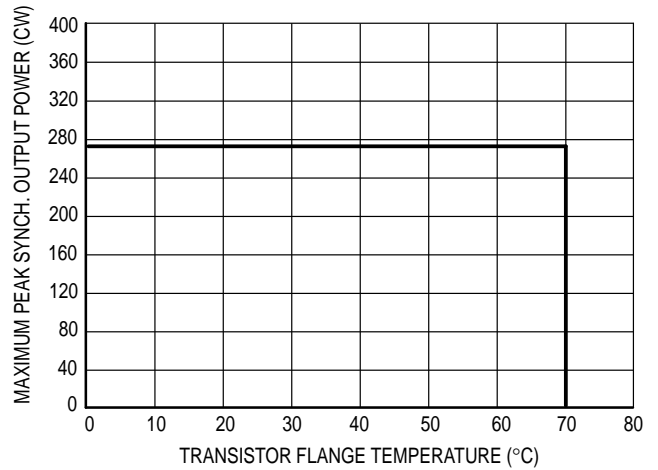

Figure 2. Maximum Peak Synchronizing Output Power (B/G Standard) versus Temperature

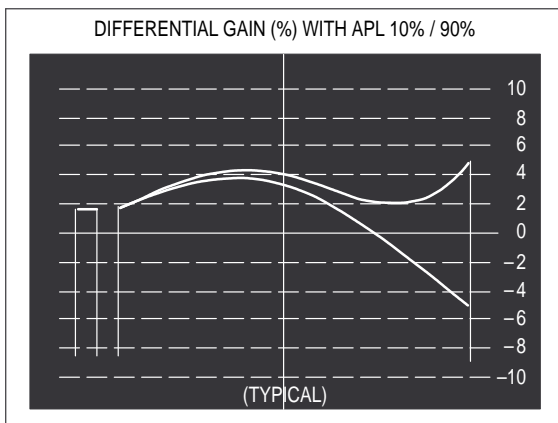

Figure 3. Without Thermal Compensation

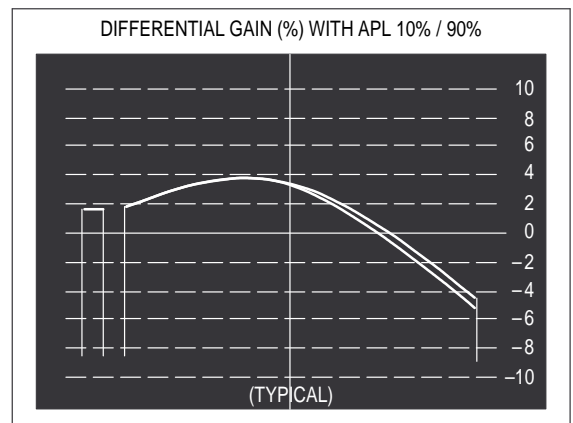
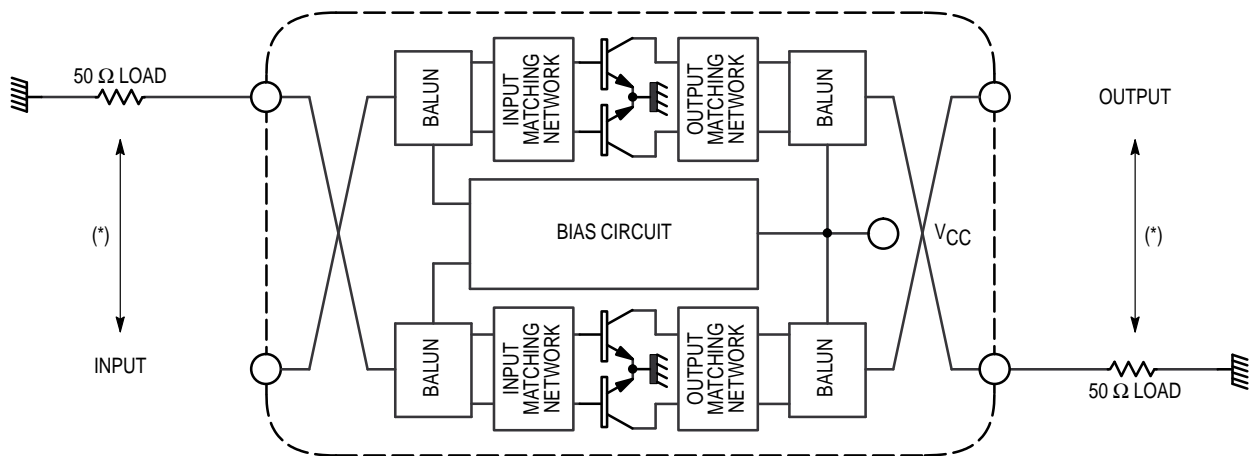

Figure 4. With Thermal Compensation

WARNING: Please read instructions carefully for operating/set-up and mounting recommendations prior to operating this device.



* Loads positions can be inverted if required.

Figure 5. Internal Schematic and External Connections

CW MEASUREMENTS WITHOUT THERMAL COMPENSATION**
(see Figure 23)

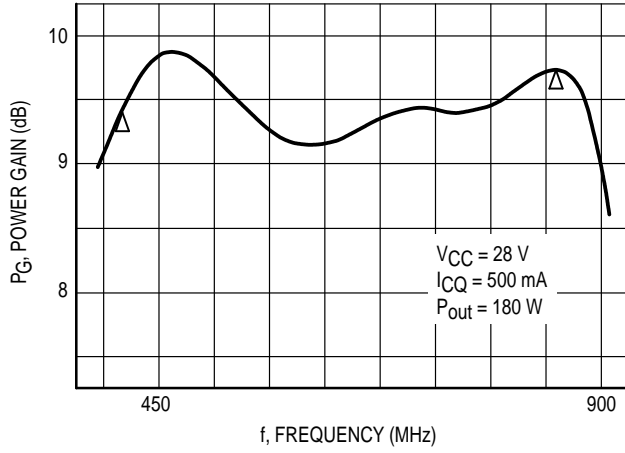

Figure 6. Power Gain versus Frequency

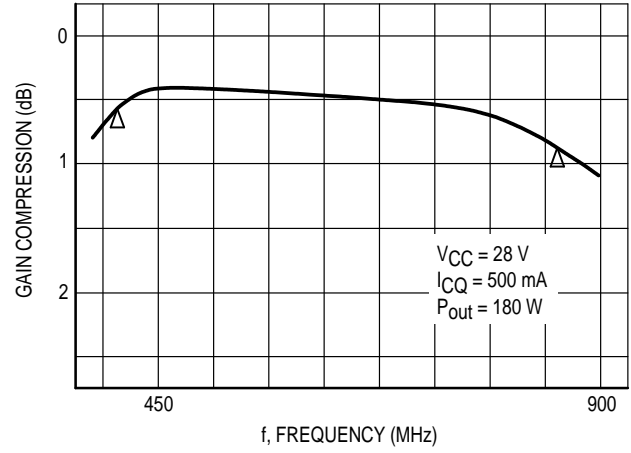

Figure 7. Gain Compression versus Frequency

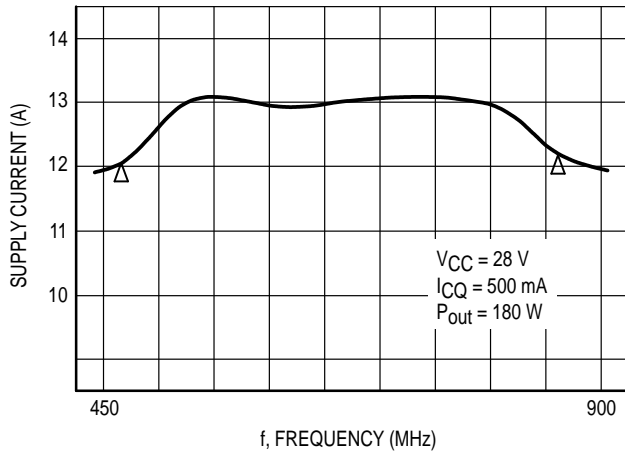

Figure 8. Supply Current versus Frequency

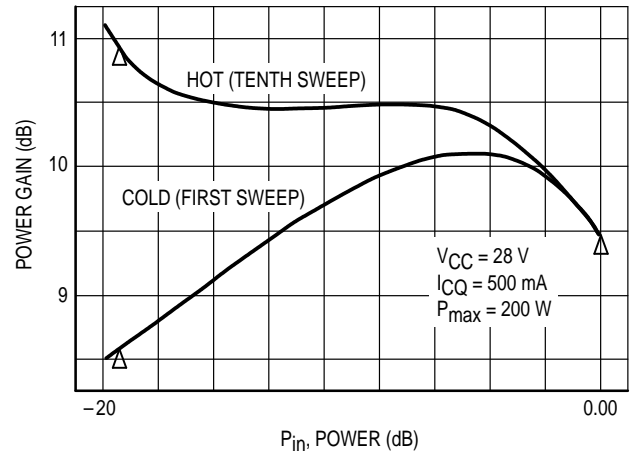

Figure 9. Power Gain versus Input Power

** Measurement results are typical values and are not guaranteed

VIDEO MEASUREMENTS WITH THERMAL COMPENSATION, B/G STANDARD
 (Measurement results are typical values and are not guaranteed)

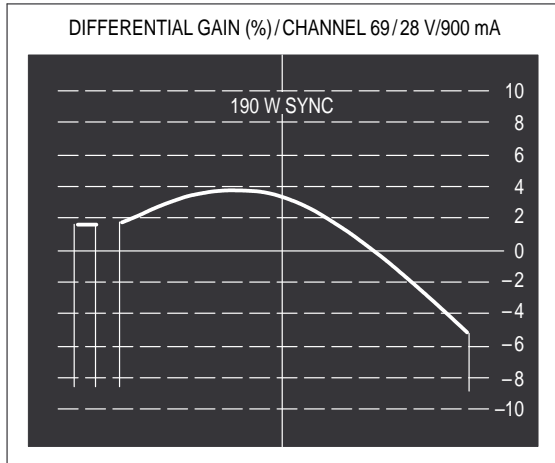

Figure 10. Differential Gain 190 W Sync

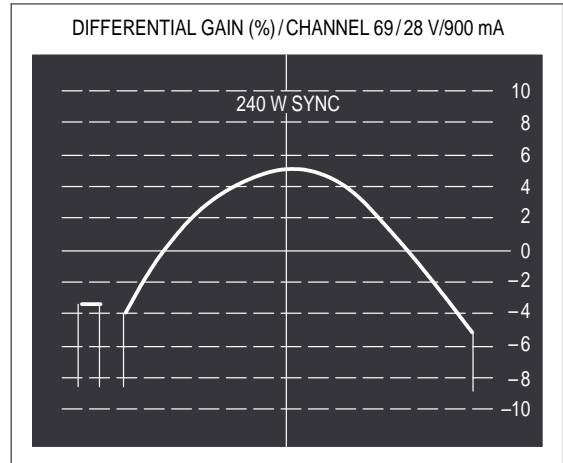

Figure 11. Differential Gain 240 W Sync

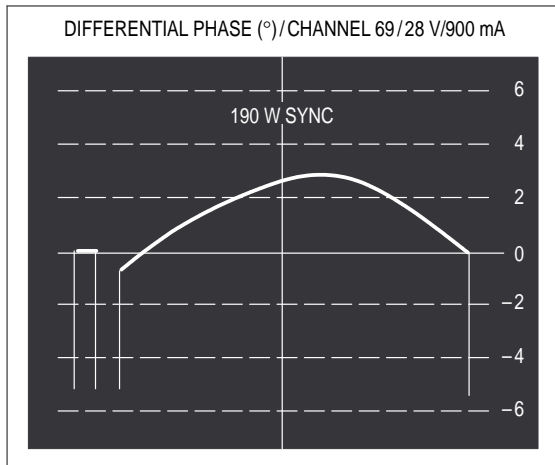

Figure 12. Differential Phase 190 W Sync

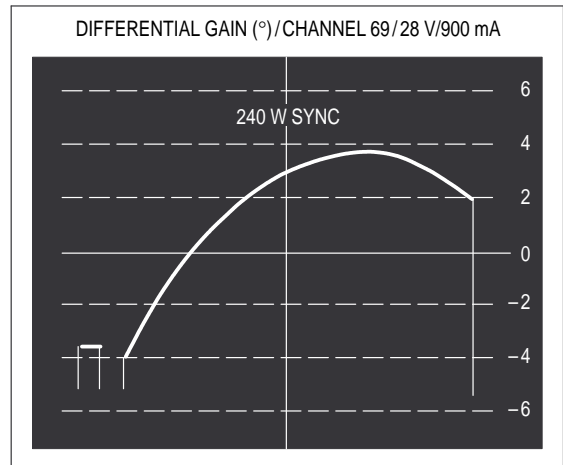
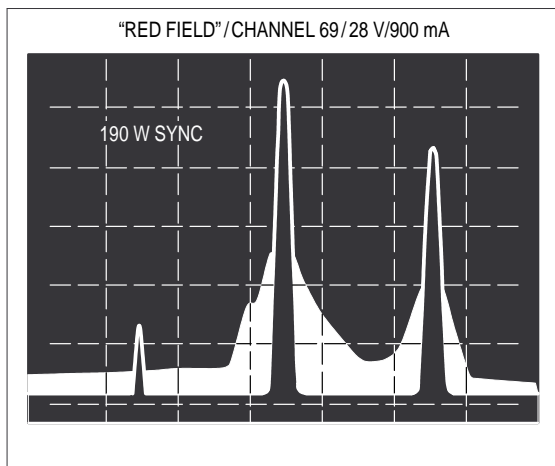
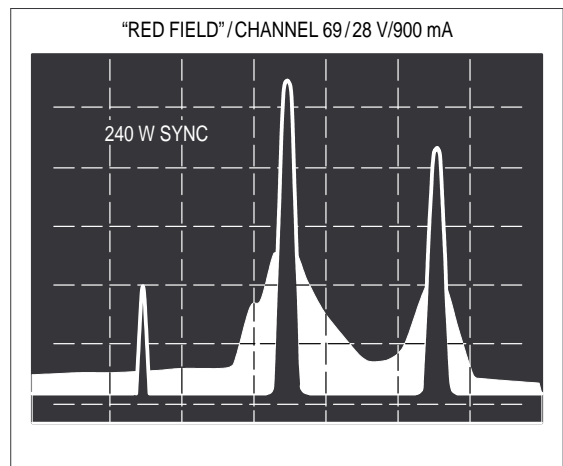

Figure 13. Differential Phase 240 W Sync



SIDE BAND REGENERATION 10 dB/div-2 MHz/div

Figure 14. "Red Field" 190 W Sync



SIDE BAND REGENERATION 10 dB/div-2 MHz/div

Figure 15. "Red Field" 240 W Sync

VIDEO MEASUREMENTS WITH THERMAL COMPENSATION, BG STANDARD
 (Measurement results are typical values and are not guaranteed)

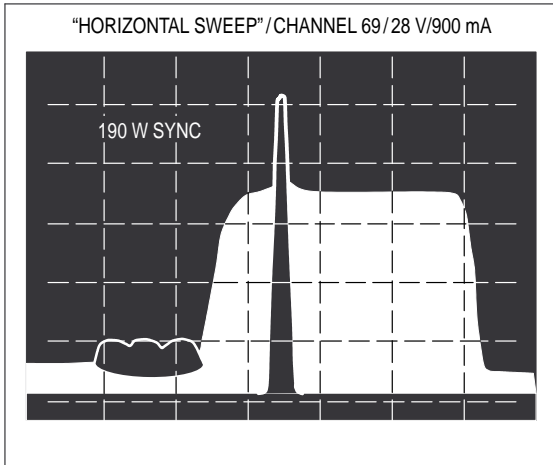

SIDE BAND REGENERATION 10 dB/div-2 MHz/div
Figure 16. "Horizontal Sweep" 190 W Sync

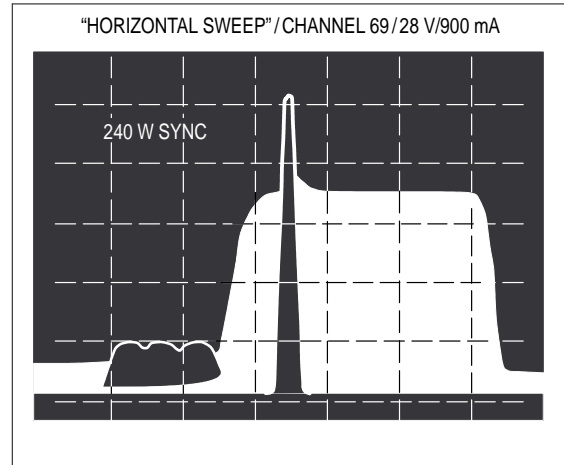

SIDE BAND REGENERATION 10 dB/div-2 MHz/div
Figure 17. "Horizontal Sweep" 240 W Sync

RELATIVE INPUT SYNC. LEVEL TO MAINTAIN OUTPUT
 SYNC. @ 27% OF RF POWER

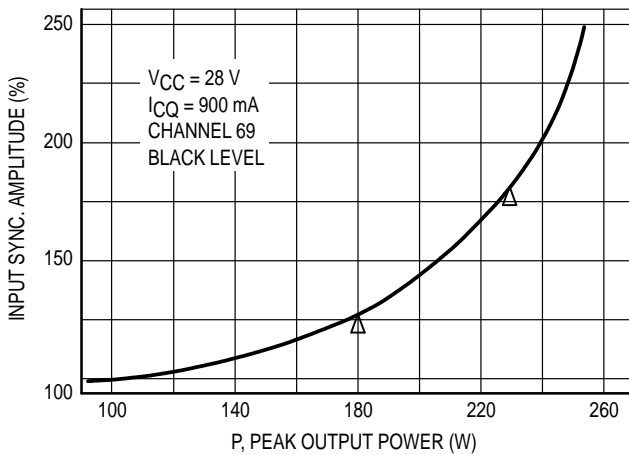

Figure 18. Input Sync. versus Output Power

POWER SWEEP ON A NETWORK ANALYZER
 (GAIN MAGNITUDE & GAIN PHASE)

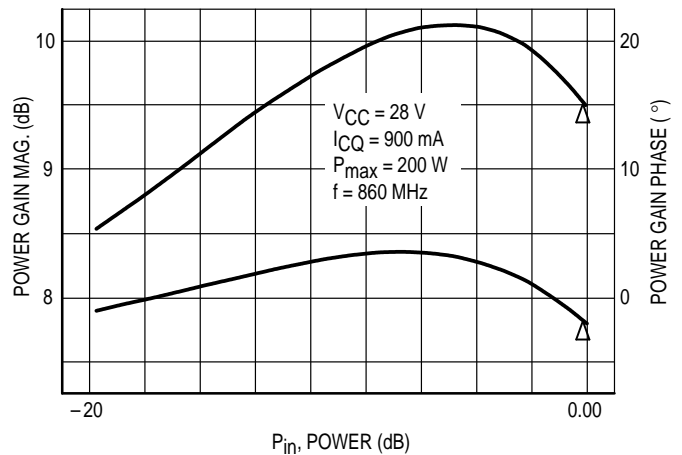

Figure 19. Power Gain versus Input Power

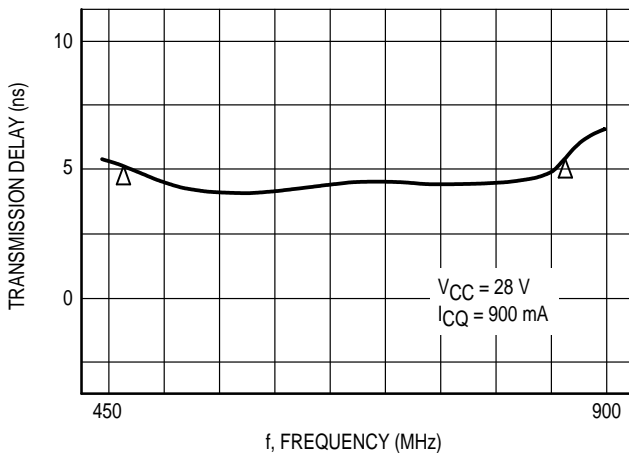

Figure 20. Delay versus Frequency

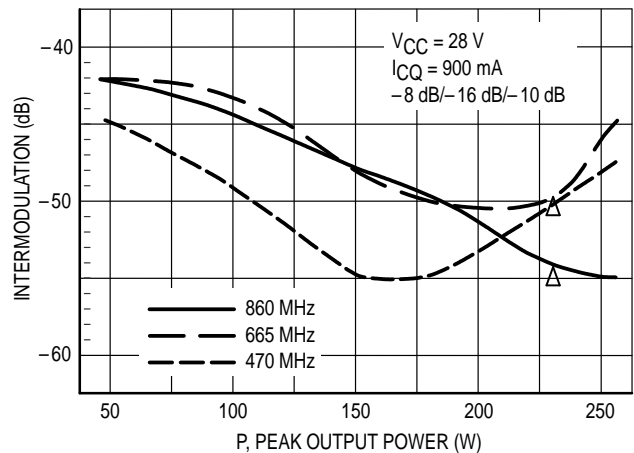

Figure 21. Intermodulation versus Output Power

OPERATING AND SET-UP RECOMMENDATIONS

1. QUIESCENT CURRENT

- **With Thermal Compensation:** The amplifier is tuned in the factory at 28 V/900 mA (total current) with the compensation "ON." Depending on the temperature of the amplifier and of the RF transistor, this value can be slightly different but it does not affect the overall performances.
- **Without Thermal Compensation:** If the amplifier has to be used without the compensation, P1 (tuning of quiescent current) has to be set-up in its initial position before applying power supply (see Figure 22). When power supply is applied P1 is tuned to obtain 500 mA.
- **Max. current:** In any case I_Q must not exceed 1.2 A.

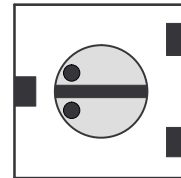

Figure 22. Initial Position of P1

2. THERMAL COMPENSATION

The amplifier is tuned in the factory for optimum compensation at 180 W peak, B/G standard, channel 69. If the amplifier is used at a different level (driver for instance), the compensation may not be optimized and can be retuned by using P2.

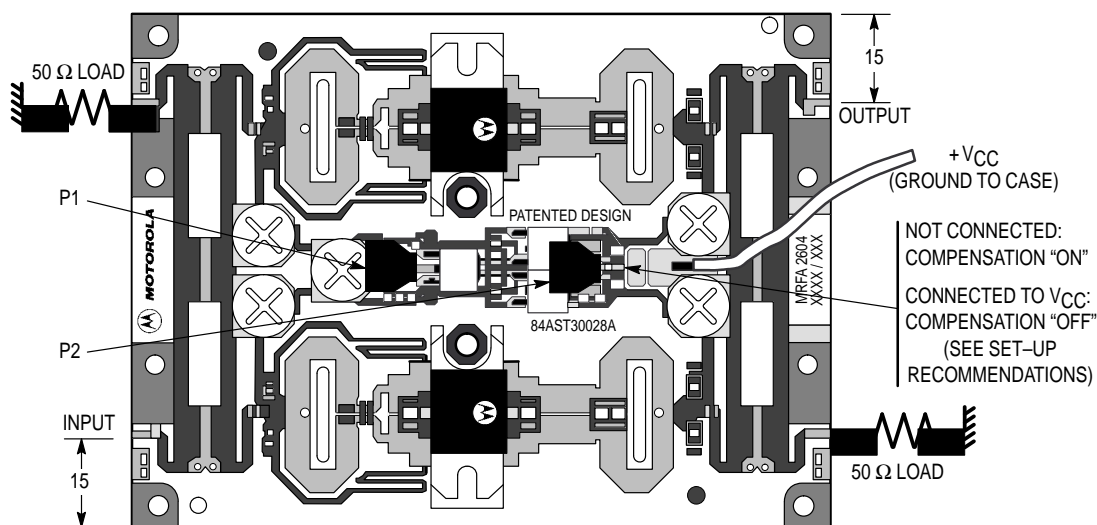

Figure 23. MRFA2604 Connections

MOUNTING RECOMMENDATIONS

1. HEATSINK TOOLING

- Flatness: better than 0.03 mm
- Roughness: Typical value 0.8

2. SCREWS

- CHC M3 x 10 for Copper/Aluminum Heatsink
- Socket head cap screws
- Material: Nickel plated steel

3. WASHERS

- Split lock washers WZ Ø3 + Flat washers ZU Ø3

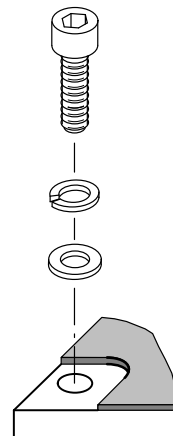

MOUNTING RECOMMENDATIONS (cont')

5. THERMAL COMPOUND:

- Paste with silicones: SICERONT KF Ref. 1201 Recommended.
- Thickness: optimum between 0.06 mm and 0.15 mm, on the whole back surface of the amplifier.
(Typical volume: 700 mm³ for 0.1 mm thickness)
(Equivalent weight: 1.5 g for 2.2 density paste).

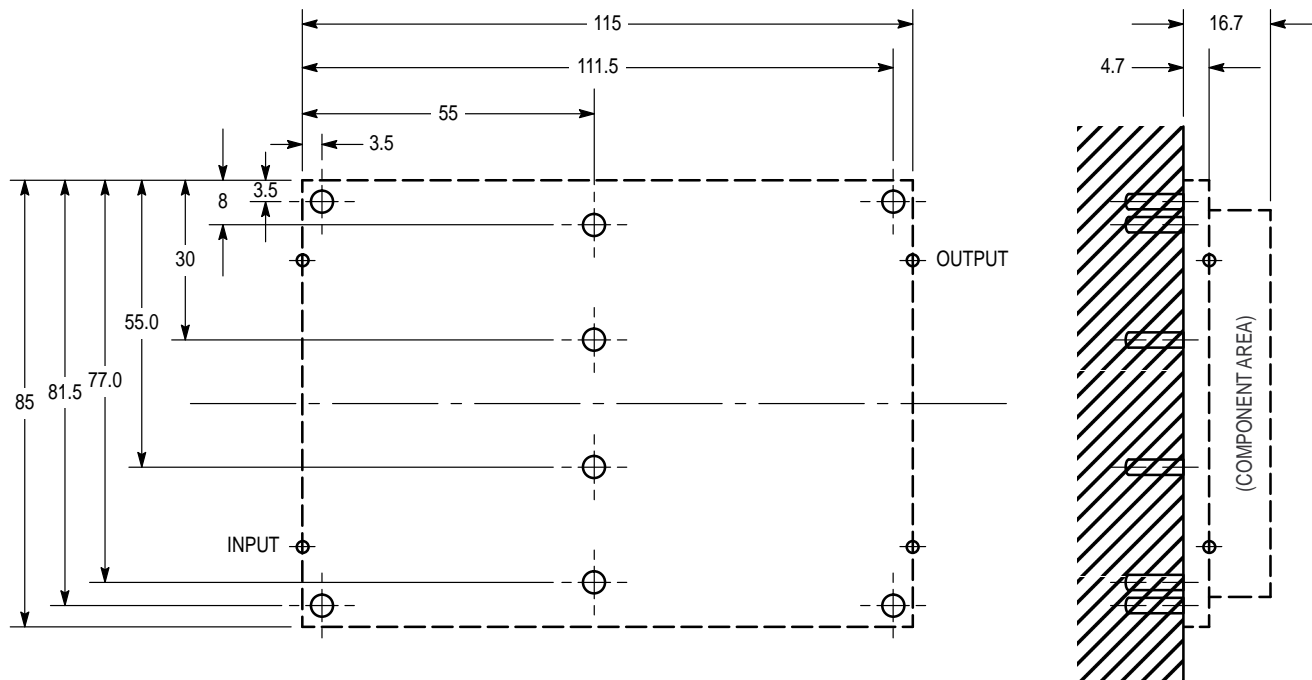

6. TIGHTENING SEQUENCE:

Engage all screws down to contact, then apply torque **according to given sequence** (see drawing on the right).

7. TORQUE:

Maximum Recommended Torque: 12 Kg.cm (10.5 in. lbs.)

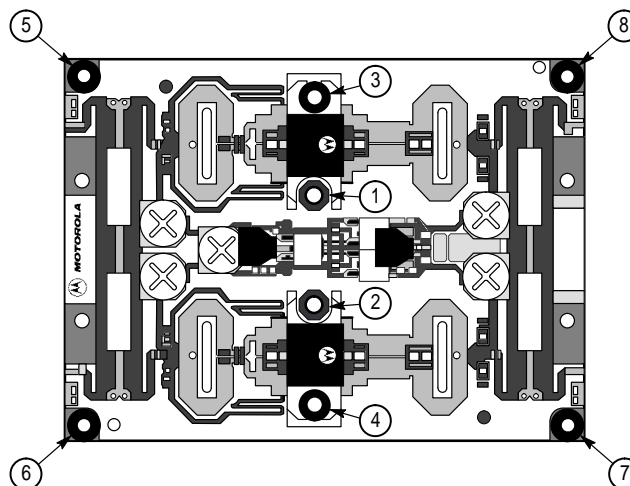

PACKAGE DIMENSIONS

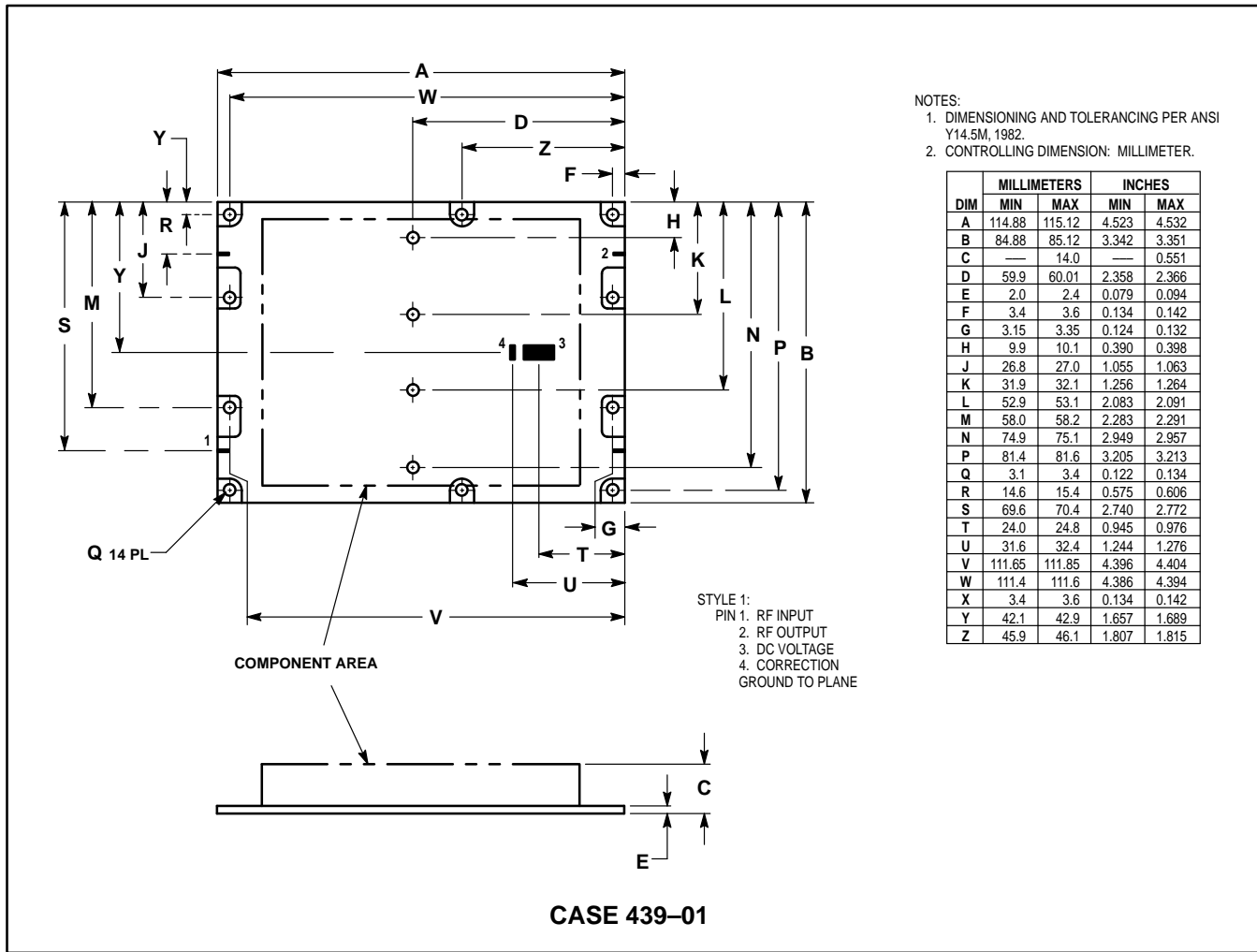

Motorola reserves the right to make changes without further notice to any products herein. Motorola makes no warranty, representation or guarantee regarding the suitability of its products for any particular purpose, nor does Motorola assume any liability arising out of the application or use of any product or circuit, and specifically disclaims any and all liability, including without limitation consequential or incidental damages. "Typical" parameters can and do vary in different applications. All operating parameters, including "Typicals" must be validated for each customer application by customer's technical experts. Motorola does not convey any license under its patent rights nor the rights of others. Motorola products are not designed, intended, or authorized for use as components in systems intended for surgical implant into the body, or other applications intended to support or sustain life, or for any other application in which the failure of the Motorola product could create a situation where personal injury or death may occur. Should Buyer purchase or use Motorola products for any such unintended or unauthorized application, Buyer shall indemnify and hold Motorola and its officers, employees, subsidiaries, affiliates, and distributors harmless against all claims, costs, damages, and expenses, and reasonable attorney fees arising out of, directly or indirectly, any claim of personal injury or death associated with such unintended or unauthorized use, even if such claim alleges that Motorola was negligent regarding the design or manufacture of the part. Motorola and are registered trademarks of Motorola, Inc. Motorola, Inc. is an Equal Opportunity/Affirmative Action Employer.

How to reach us:
USA / EUROPE: Motorola Literature Distribution;
 P.O. Box 20912; Phoenix, Arizona 85036. 1-800-441-2447

JAPAN: Nippon Motorola Ltd.; Tatsumi-SPD-JLDC, Toshikatsu Otsuki,
 6F Seibu-Butsuryu-Center, 3-14-2 Tatsumi Koto-Ku, Tokyo 135, Japan. 03-3521-8315

MFAX: RMFAX0@email.sps.mot.com - TOUCHTONE (602) 244-6609
INTERNET: http://Design-NET.com

HONG KONG: Motorola Semiconductors H.K. Ltd.; 8B Tai Ping Industrial Park,
 51 Ting Kok Road, Tai Po, N.T., Hong Kong. 852-26629298



MRFA2604/D

