



Dual N-Channel 30-V (D-S) MOSFET with Schottky Diode

PRODUCT SUMMARY			
	V _{DS} (V)	r _{DS(on)} (Ω)	I _D (A)
Channel-1	30	0.022 @ V _{GS} = 10 V	7.5
		0.030 @ V _{GS} = 4.5 V	6.5
Channel-2		0.022 @ V _{GS} = 10 V	7.5
		0.028 @ V _{GS} = 4.5 V	6.5

SCHOTTKY PRODUCT SUMMARY		
V _{DS} (V)	V _{SD} (V) Diode Forward Voltage	I _F (A)
30	0.50 V @ 1.0 A	2.0

FEATURES

- LITTLE FOOT® Plus Schottky
- Si4830DY Pin Compatible
- PWM Optimized
- 100% R_g Tested

APPLICATIONS

- Asymmetrical Buck-Boost DC/DC Converter

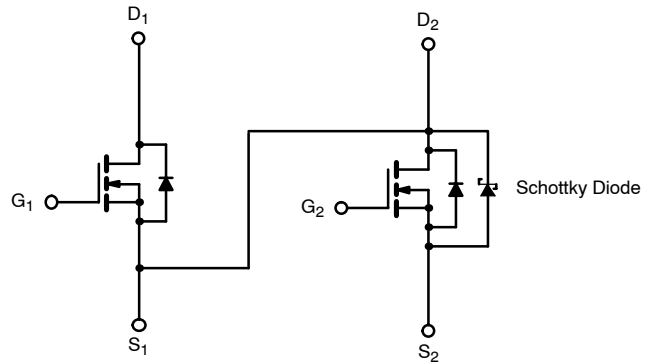
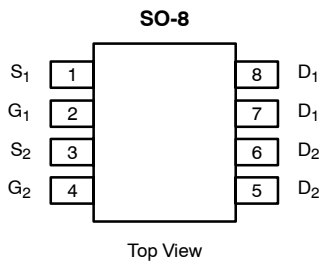

Ordering Information: Si4370DY—E3 (Lead Free)
Si4370DY-T1—E3 (Lead Free with Tape and Reel)

ABSOLUTE MAXIMUM RATINGS (T _A = 25 °C UNLESS OTHERWISE NOTED)						
Parameter	Symbol	10 secs		Steady State		Unit
		Channel-1	Channel-2	Channel-1	Channel-2	
Drain-Source Voltage	V _{DS}	30				V
Gate-Source Voltage	V _{GS}	± 20	± 12	± 20	± 12	
Continuous Drain Current (T _J = 150 °C) ^a	I _D	T _A = 25 °C		5.7		A
		T _A = 70 °C		4.6		
Pulsed Drain Current	I _{DM}	30				
Continuous Source Current (Diode Conduction) ^a	I _S	1.7		0.9		
Maximum Power Dissipation ^a	P _D	T _A = 25 °C		1.1		W
		T _A = 70 °C		0.7		
Operating Junction and Storage Temperature Range	T _J , T _{stg}	-55 to 150				°C

THERMAL RESISTANCE RATINGS							
Parameter	Symbol	MOSFET		Schottky		Unit	
		Typ	Max	Typ	Max		
Maximum Junction-to-Ambient ^a	R _{thJA}	t ≤ 10 sec	52	62.5	53	62.5	°C/W
		Steady-State	93	110	93	110	
Maximum Junction-to-Foot (Drain)	R _{thJF}	Steady-State	35	40	35	40	

Notes
a. Surface Mounted on 1" x 1" FR4 Board.

MOSFET SPECIFICATIONS ($T_J = 25^\circ\text{C}$ UNLESS OTHERWISE NOTED).								
Parameter	Symbol	Test Condition	Min	Typ ^a	Max	Unit		
Static								
Gate Threshold Voltage	$V_{GS(th)}$	$V_{DS} = V_{GS}, I_D = 250 \mu\text{A}$	Ch-1	1.0		3.0	V	
			Ch-2	0.8		2.0		
Gate-Body Leakage	I_{GSS}	$V_{DS} = 0 \text{ V}, V_{GS} = \pm 20 \text{ V}$	Ch-1			± 100	nA	
		$V_{DS} = 0 \text{ V}, V_{GS} = \pm 12 \text{ V}$	Ch-2			± 100		
Zero Gate Voltage Drain Current	I_{DSS}	$V_{DS} = 30 \text{ V}, V_{GS} = 0 \text{ V}$	Ch-1			1	μA	
			Ch-2			100		
		$V_{DS} = 30 \text{ V}, V_{GS} = 0 \text{ V}, T_J = 85^\circ\text{C}$	Ch-1			15		
			Ch-2			2000		
On-State Drain Current ^b	$I_{D(on)}$	$V_{DS} = 5 \text{ V}, V_{GS} = 10 \text{ V}$	Ch-1	20			A	
			Ch-2	20				
Drain-Source On-State Resistance ^b	$r_{DS(on)}$	$V_{GS} = 10 \text{ V}, I_D = 7.5 \text{ A}$	Ch-1		0.014	0.022	Ω	
			Ch-2		0.015	0.022		
		$V_{GS} = 4.5 \text{ V}, I_D = 6.5 \text{ A}$	Ch-1		0.024	0.030		
			Ch-2		0.020	0.028		
Forward Transconductance ^b	g_{fs}	$V_{DS} = 15 \text{ V}, I_D = 7.5 \text{ A}$	Ch-1		19		S	
			Ch-2		21			
Diode Forward Voltage ^b	V_{SD}	$I_S = 1 \text{ A}, V_{GS} = 0 \text{ V}$	Ch-1		0.75	1.2	V	
			Ch-2		0.47	0.5		
Dynamic^a								
Total Gate Charge	Q_g	$V_{DS} = 15 \text{ V}, V_{GS} = 4.5 \text{ V}, I_D = 7.5 \text{ A}$	Ch-1		7	11	nC	
			Ch-2		11.5	18		
Gate-Source Charge	Q_{GS}		Ch-1		2.9			
			Ch-2		3.8			
Gate-Drain Charge	Q_{gd}		Ch-1		2.5			
			Ch-2		3.5			
Gate Resistance	R_g		Ch-1	0.5	1.5	1.9	Ω	
			Ch-2	0.5	1.8	1.9		
Turn-On Delay Time	$t_{d(on)}$		$V_{DD} = 15 \text{ V}, R_L = 15 \Omega$ $I_D \approx 1 \text{ A}, V_{GEN} = 10 \text{ V}, R_g = 6 \Omega$	Ch-1		9	15	ns
				Ch-2		12	20	
Rise Time	t_r	Ch-1			10	17		
		Ch-2			10	17		
Turn-Off Delay Time	$t_{d(off)}$	Ch-1			19	30		
		Ch-2			40	66		
Fall Time	t_f	Ch-1			9	15		
		Ch-2			9	15		
Source-Drain Reverse Recovery Time	t_{rr}	$I_F = 1.7 \text{ A}, di/dt = 100 \text{ A}/\mu\text{s}$		Ch-1		35	55	
				Ch-2		28	45	

Notes

- a. Guaranteed by design, not subject to production testing.
b. Pulse test; pulse width $\leq 300 \mu\text{s}$, duty cycle $\leq 2\%$.

SCHOTTKY SPECIFICATIONS ($T_J = 25^\circ\text{C}$ UNLESS OTHERWISE NOTED)							
Parameter	Symbol	Test Condition	Min	Typ	Max	Unit	
Forward Voltage Drop	V_F	$I_F = 1.0 \text{ A}$		0.47	0.50	V	
		$I_F = 1.0 \text{ A}, T_J = 125^\circ\text{C}$		0.36	0.42		
Maximum Reverse Leakage Current	I_{rm}	$V_r = 30 \text{ V}$		0.004	0.100	mA	
		$V_r = 30 \text{ V}, T_J = 100^\circ\text{C}$		0.7	10		
		$V_r = -30 \text{ V}, T_J = 125^\circ\text{C}$		3.0	20		
Junction Capacitance	C_T	$V_r = 10 \text{ V}$		50		pF	



TYPICAL CHARACTERISTICS (25°C UNLESS NOTED) MOSFET CHANNEL-1

Output Characteristics

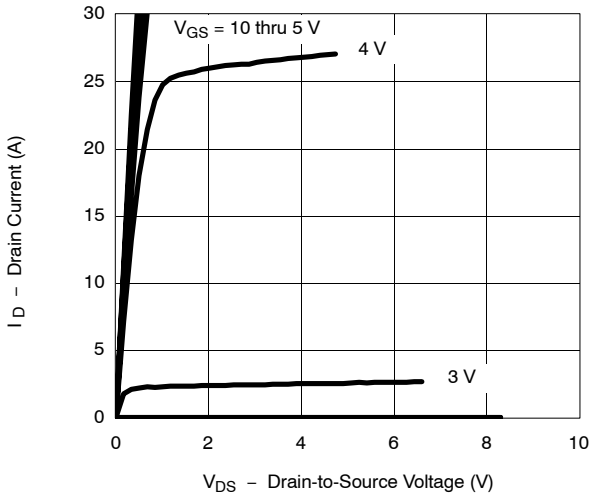

Transfer Characteristics

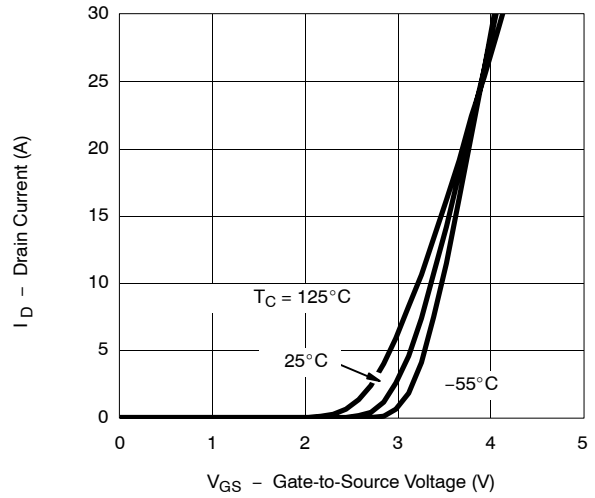

On-Resistance vs. Drain Current

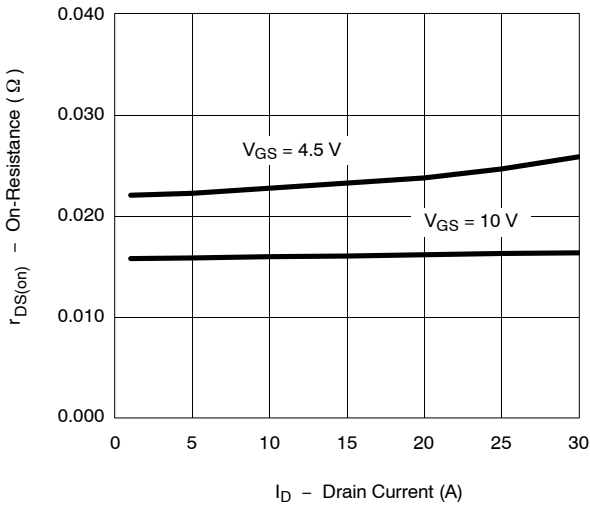

Capacitance

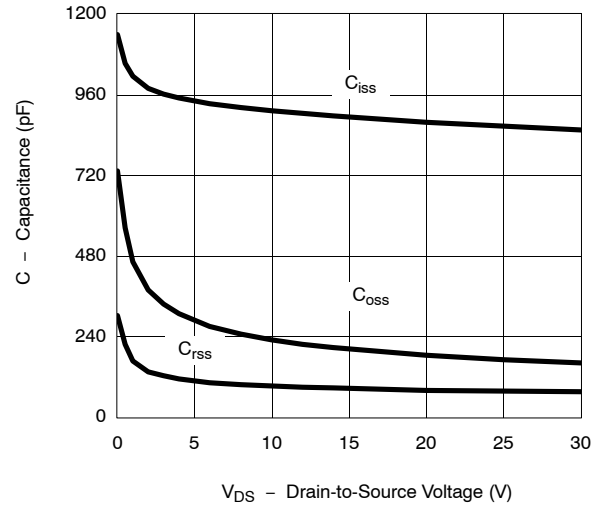

Gate Charge

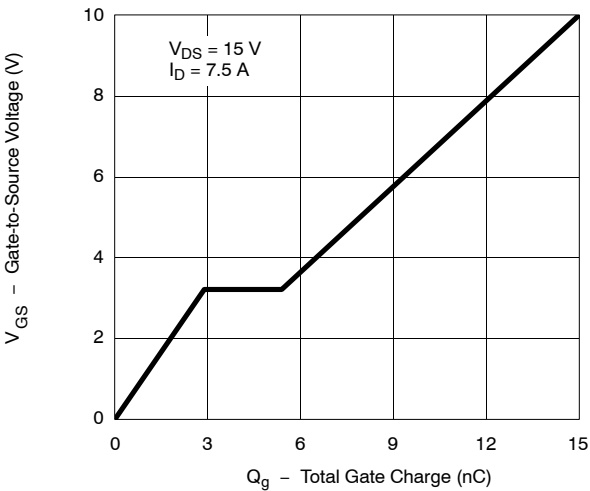

On-Resistance vs. Junction Temperature

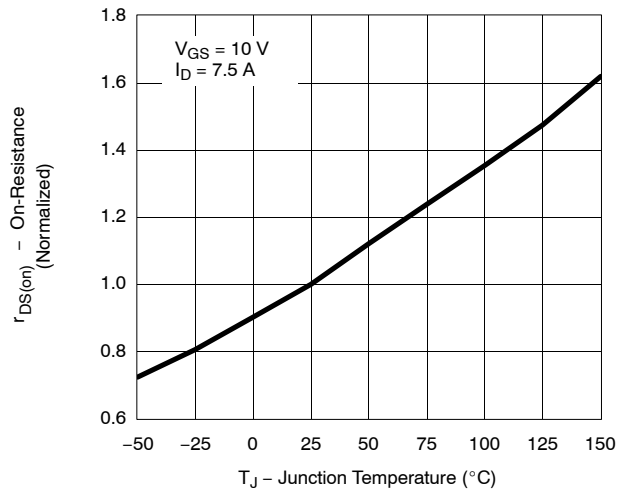



TYPICAL CHARACTERISTICS (25 °C UNLESS NOTED)

MOSFET CHANNEL-1

Source-Drain Diode Forward Voltage

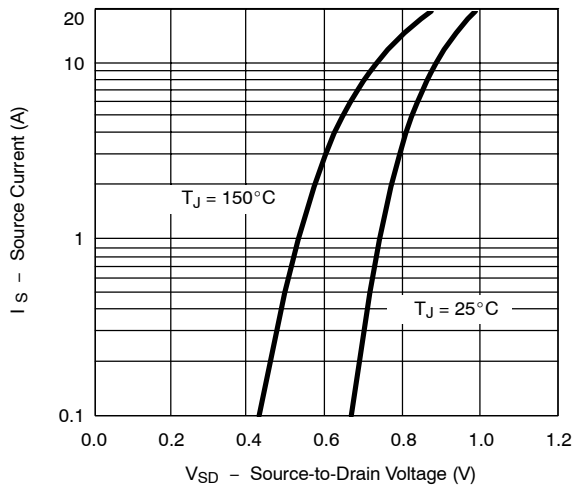

On-Resistance vs. Gate-to-Source Voltage

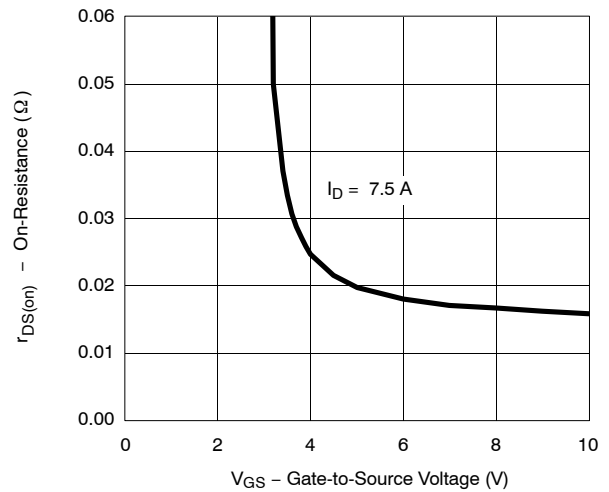

Threshold Voltage

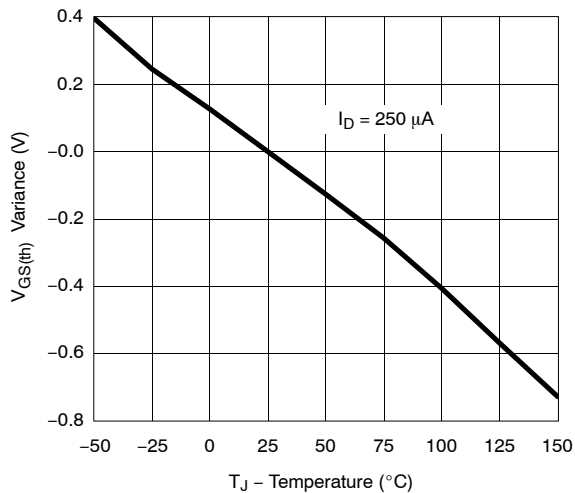

Single Pulse Power, Junction-to-Ambient

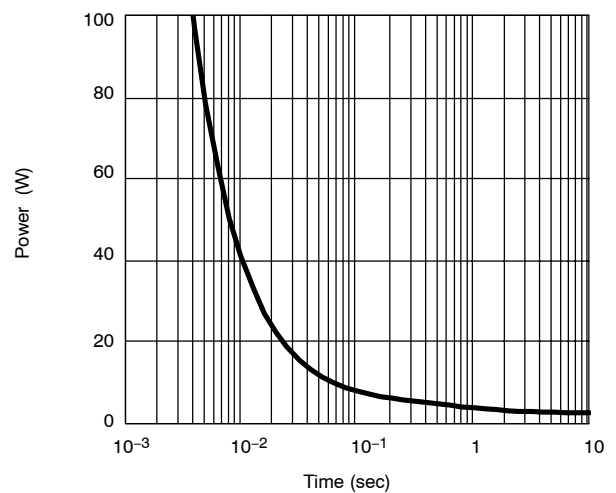

Safe Operating Area, Junction-to-Foot

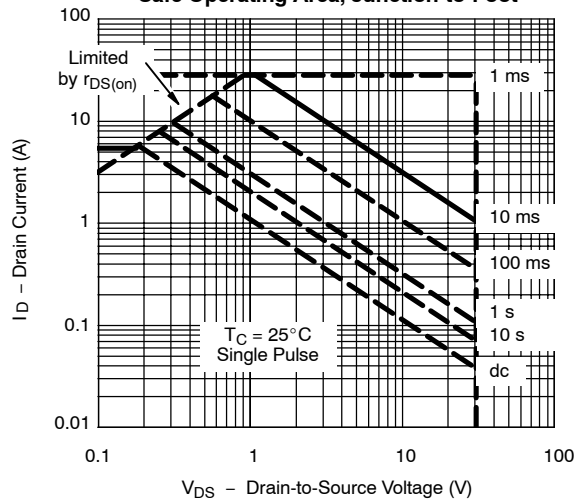



TYPICAL CHARACTERISTICS (25 °C UNLESS NOTED) MOSFET CHANNEL 1

Normalized Thermal Transient Impedance, Junction-to-Ambient

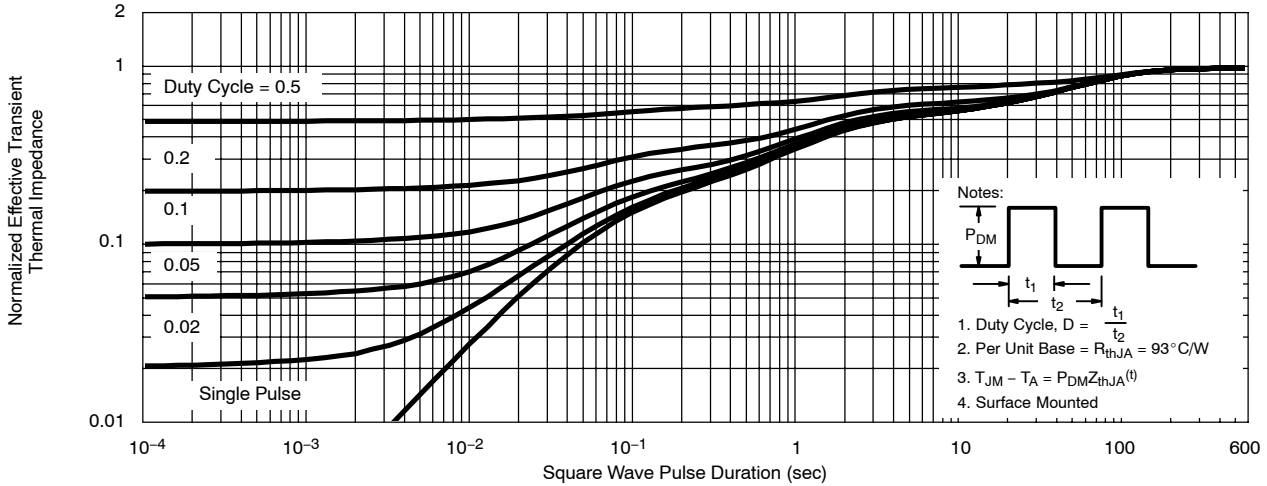

Normalized Thermal Transient Impedance, Junction-to-Foot

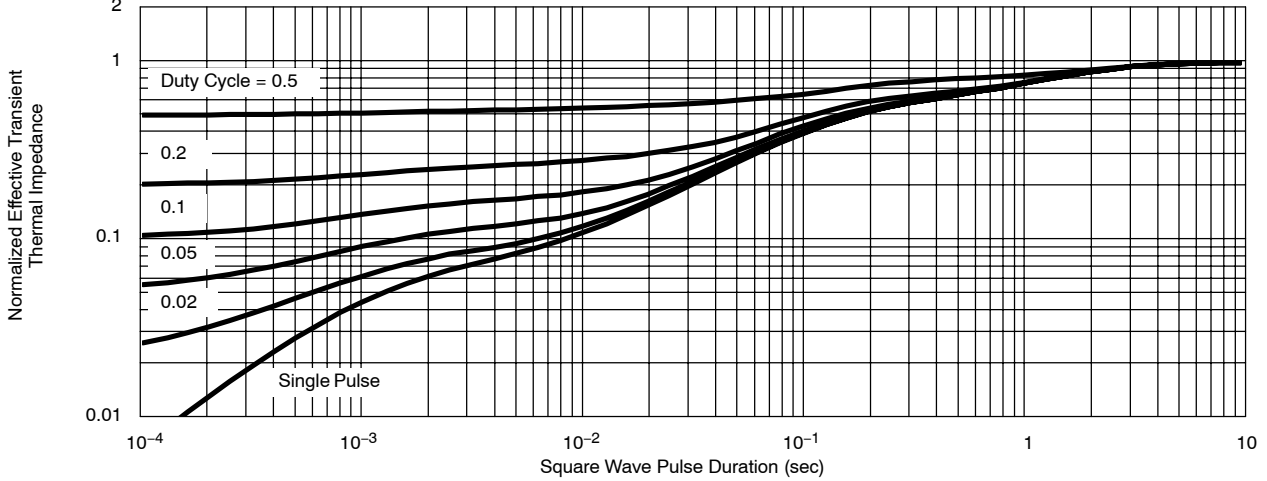

TYPICAL CHARACTERISTICS (25°C UNLESS NOTED)

MOSFET CHANNEL-2

Output Characteristics

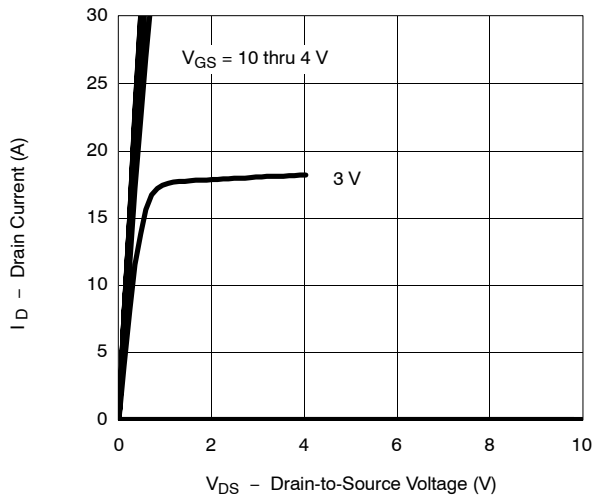

Transfer Characteristics

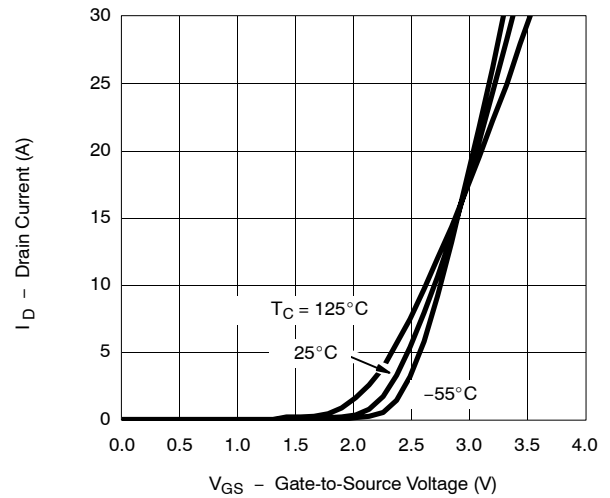

On-Resistance vs. Drain Current

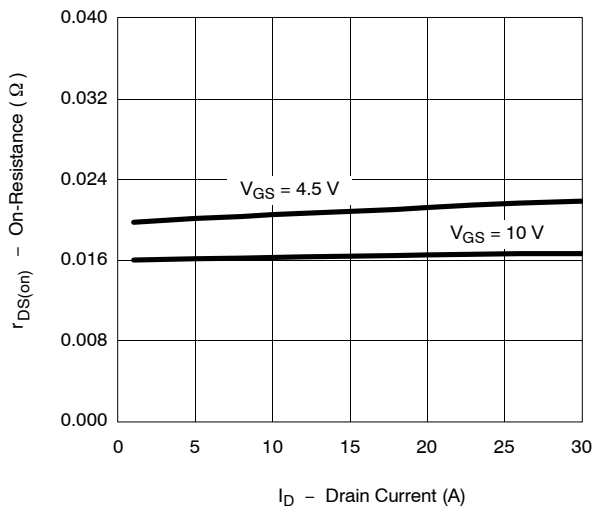

Capacitance

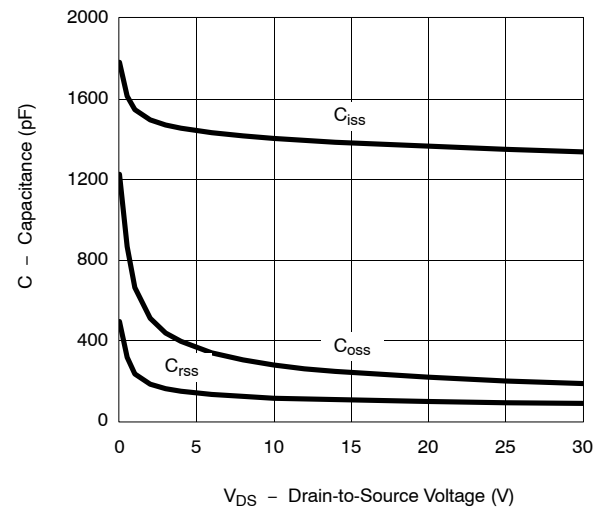

Gate Charge

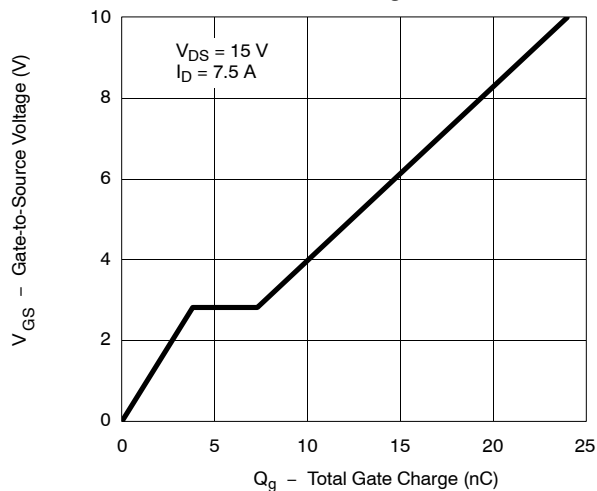

On-Resistance vs. Junction Temperature

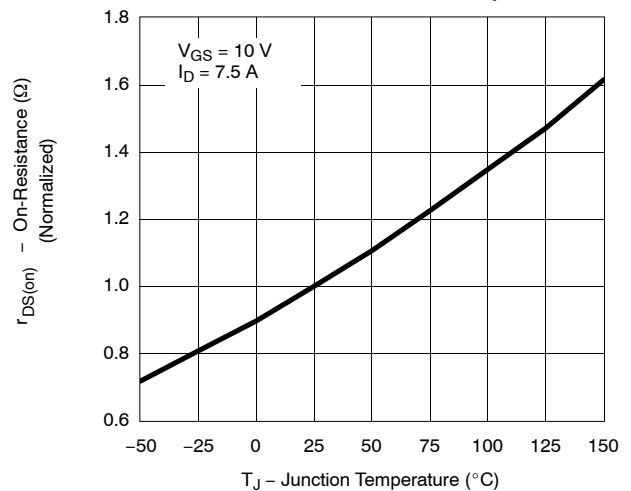



TYPICAL CHARACTERISTICS (25°C UNLESS NOTED) MOSFET CHANNEL-2

Source-Drain Diode Forward Voltage

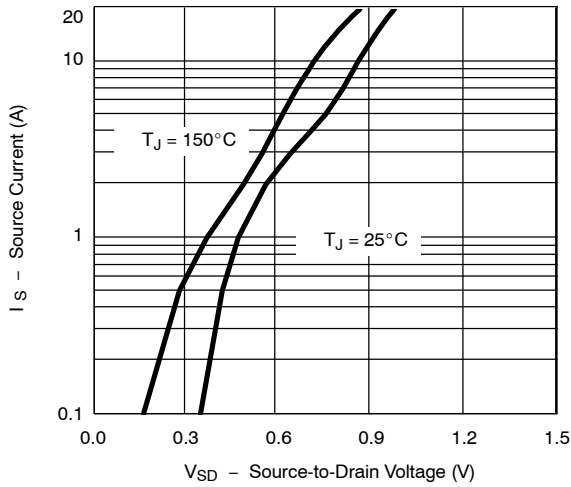

On-Resistance vs. Gate-to-Source Voltage

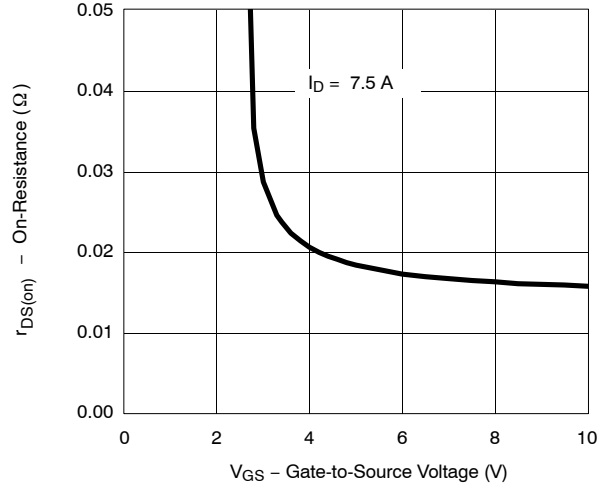

Threshold Voltage

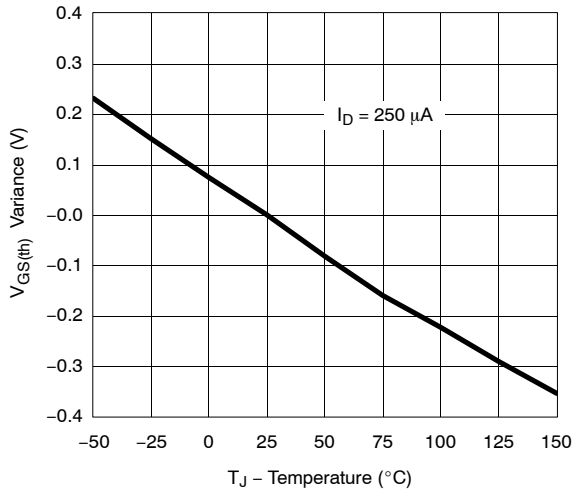

Single Pulse Power, Junction-to-Ambient

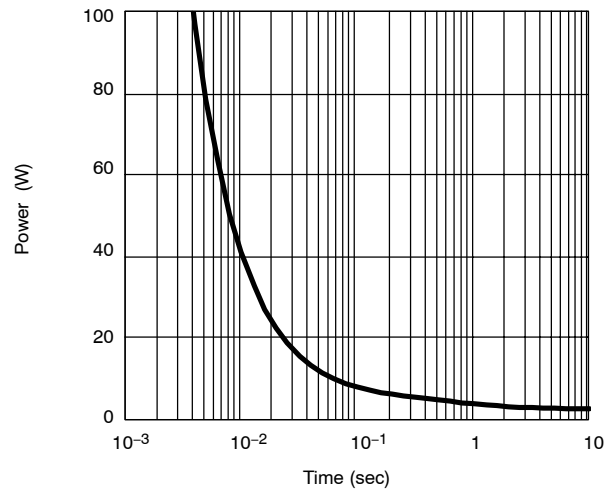

Safe Operating Area, Junction-to-Foot

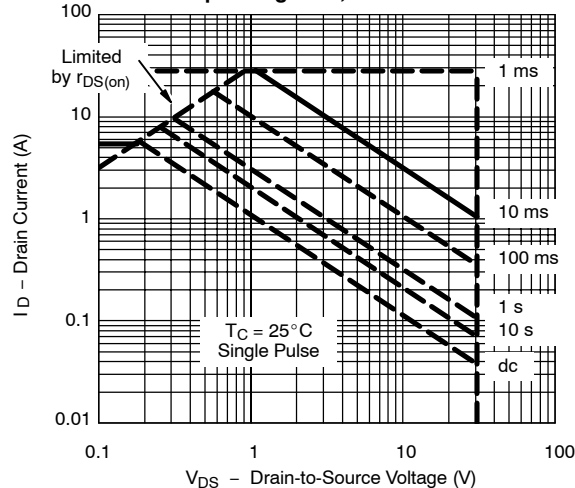

TYPICAL CHARACTERISTICS (25 °C UNLESS NOTED) MOSFET CHANNEL-2

Normalized Thermal Transient Impedance, Junction-to-Ambient

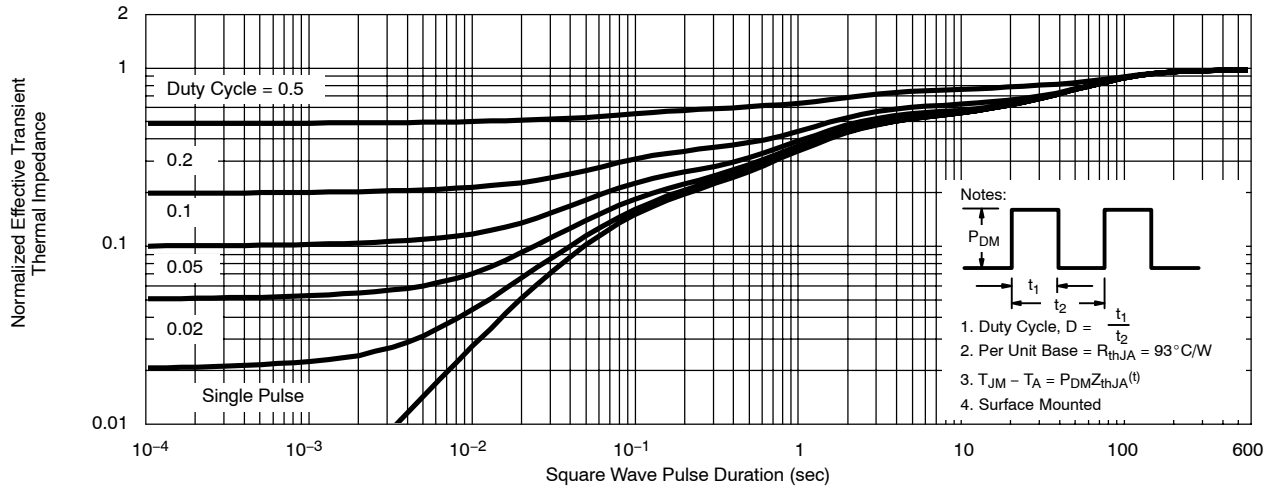

Normalized Thermal Transient Impedance, Junction-to-Foot

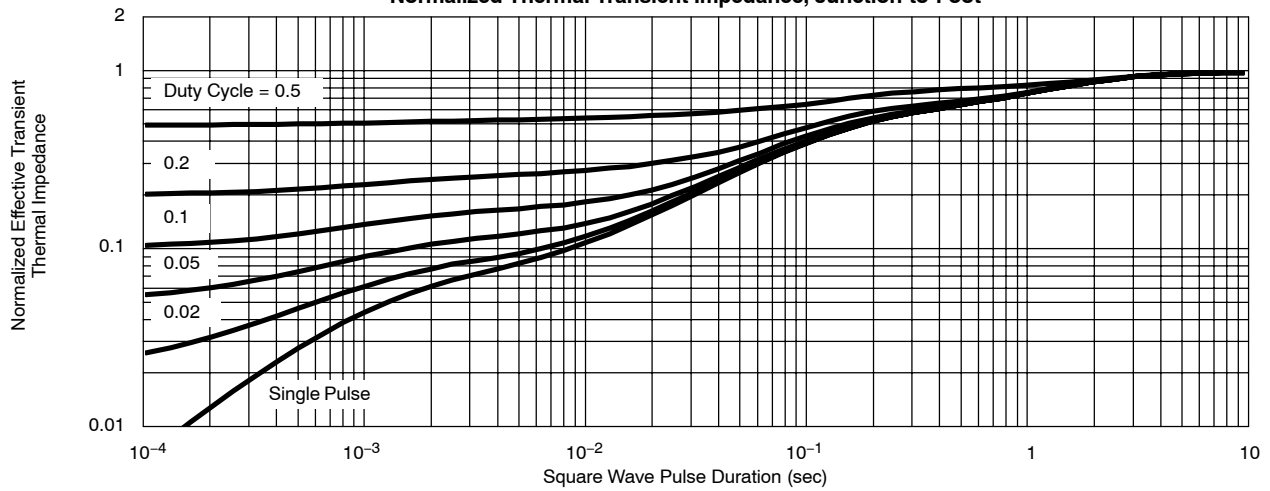



TYPICAL CHARACTERISTICS (25°C UNLESS NOTED) **SCHOTTKY**

