

**SILICON TRANSISTOR**  
**2SC4178**

**HIGH FREQUENCY AMPLIFIER**  
**NPN SILICON EPITAXIAL TRANSISTOR**

**PACKAGE DIMENSIONS**  
in millimeters

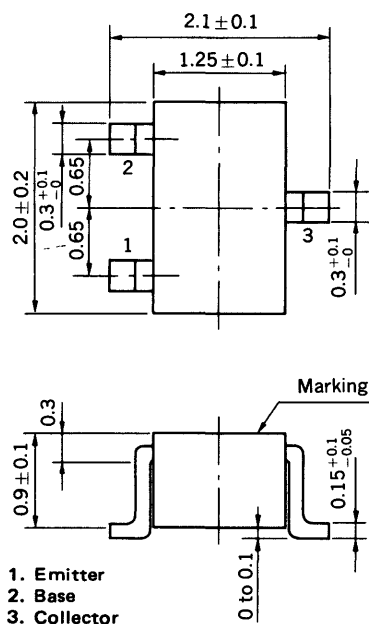

**DESCRIPTION**

The 2SC4178 is designed for use in small type equipments especially recommended for Hybrid Integrated Circuit and other applications.

**FEATURES**

- Micro package.
- High gain bandwidth product.  $f_T = 600 \text{ MHz TYP. } (I_E = -1.0 \text{ mA})$
- Low output capacitance.  $C_{ob} = 1.0 \text{ pF TYP. } (V_{CB} = 6.0 \text{ V})$

**ABSOLUTE MAXIMUM RATINGS ( $T_a = 25^\circ\text{C}$ )**

**Maximum Voltages and Current**

Collector to Base Voltage	$V_{CBO}$	30	V
Collector to Emitter Voltage	$V_{CEO}$	20	V
Emitter to Base Voltage	$V_{EBO}$	4.0	V
Collector Current	$I_C$	20	mA

**Maximum Power Dissipation**

Total Power Dissipation	$P_T$	150	mW
-------------------------	-------	-----	----

**Maximum Temperatures**

Storage Temperature	$T_{stg}$	-55 to +150	$^\circ\text{C}$
Junction Temperature	$T_j$	150	$^\circ\text{C}$

**ELECTRICAL CHARACTERISTICS ( $T_a = 25^\circ\text{C}$ )**

CHARACTERISTIC	SYMBOL	MIN.	TYP.	MAX.	UNIT	TEST CONDITIONS
Collector Cutoff Current	$I_{CBO}$			100	nA	$V_{CB} = 30 \text{ V, } I_E = 0$
DC Current Gain	$h_{FE}$	40	90	180		$V_{CE} = 6.0 \text{ V, } I_C = 1.0 \text{ mA}$
Collector Saturation Voltage	$V_{CE(sat)}$		0.1	0.3	V	$I_C = 10 \text{ mA, } I_B = 1.0 \text{ mA}$
Gain Bandwidth Product	$f_T$	400	600		MHz	$V_{CE} = 6.0 \text{ V, } I_E = -1.0 \text{ mA}$
Output Capacitance	$C_{ob}$		1.0		pF	$V_{CB} = 6.0 \text{ V, } I_E = 0, f = 1.0 \text{ MHz}$
Collector to Base Time Constant	$C_c \cdot r_{b'b}$		12		ps	$V_{CE} = 6.0 \text{ V, } I_E = -1.0 \text{ mA, } f = 31.9 \text{ MHz}$
Noise Figure	NF		3.0		dB	$V_{CE} = 6.0 \text{ V, } I_E = -1.0 \text{ mA, } R_G = 50 \Omega, f = 100 \text{ MHz}$ See Test Circuit

**Classification of  $h_{FE}$**

Marking	F12	F13	F14
$h_{FE}$ Range	40 to 80	60 to 120	90 to 180

TYPICAL CHARACTERISTICS ( $T_a = 25^\circ\text{C}$  unless otherwise noted)

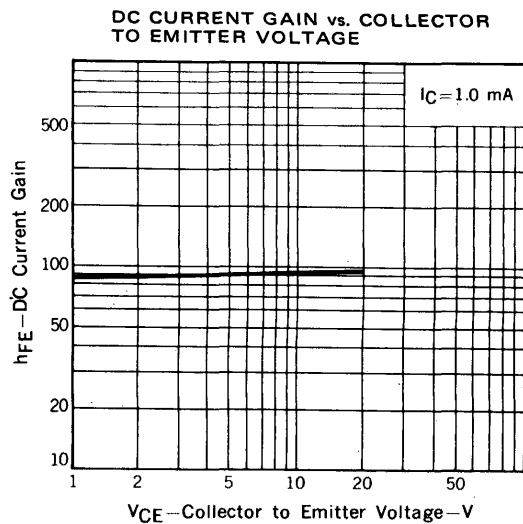
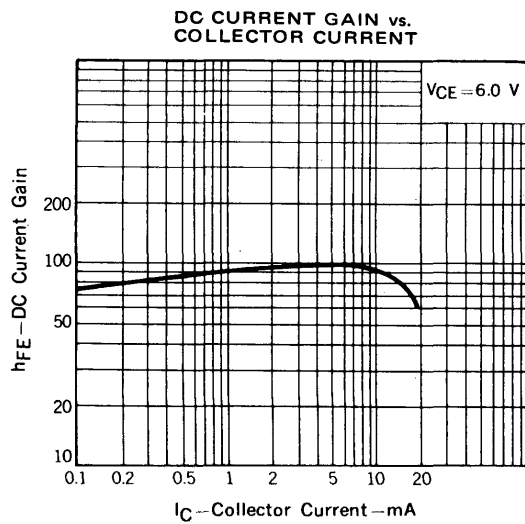
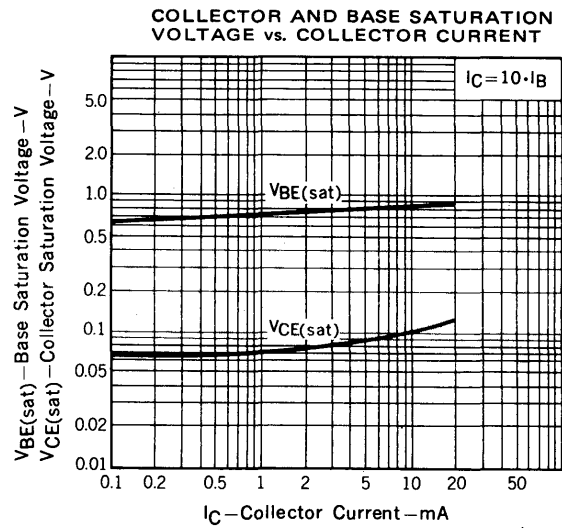
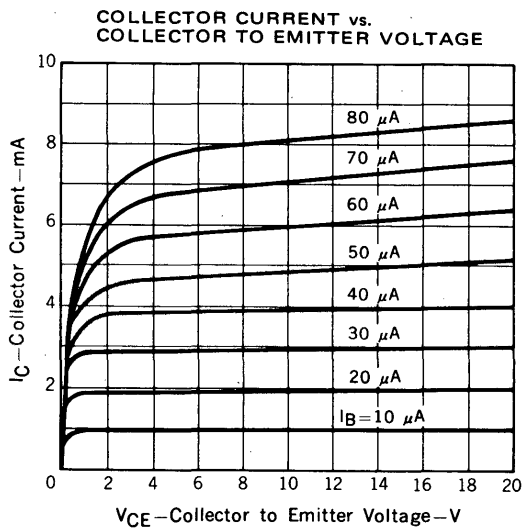
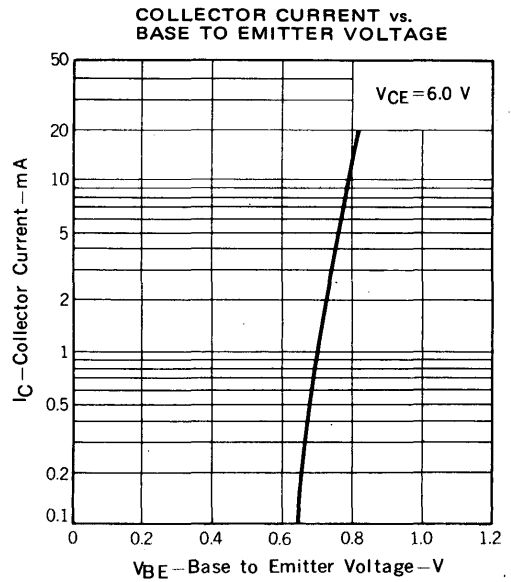
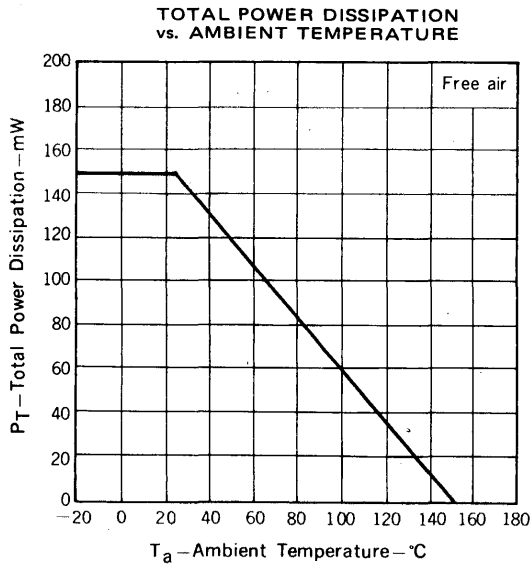

GAIN BANDWIDTH PRODUCT vs. EMITTER CURRENT

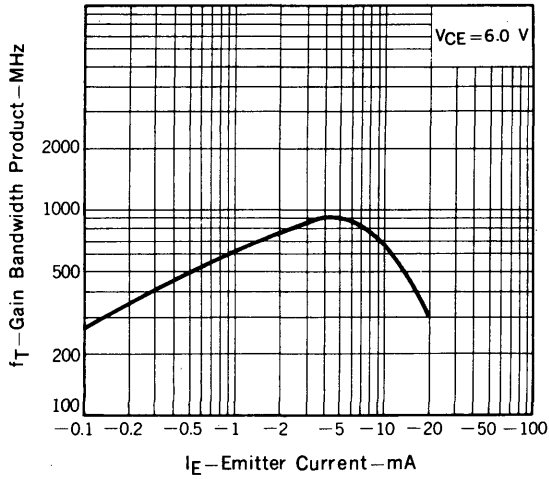

INPUT CAPACITANCE vs. EMITTER TO BASE VOLTAGE, OUTPUT CAPACITANCE vs. COLLECTOR TO BASE VOLTAGE

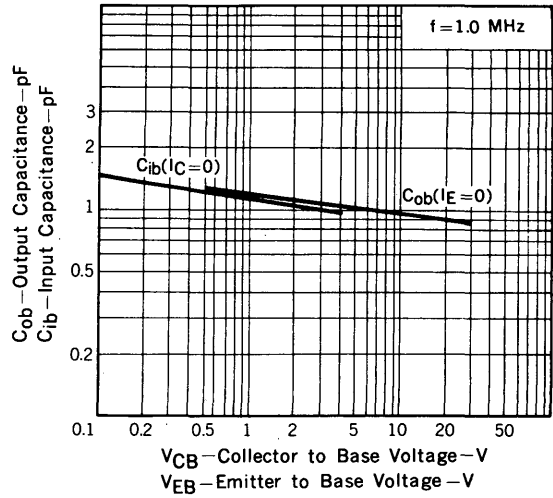

COLLECTOR TO BASE TIME CONSTANT vs. EMITTER CURRENT

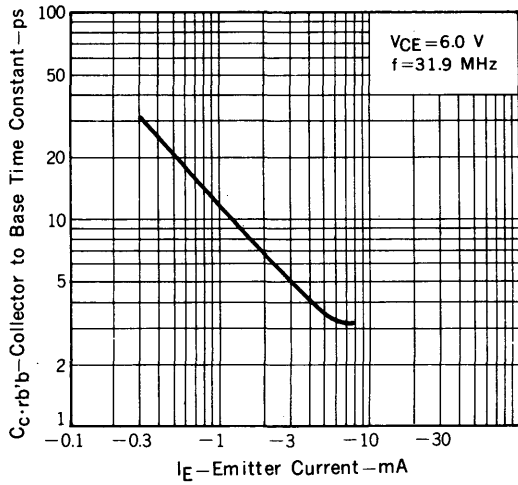

POWER GAIN, NOISE FIGURE vs. EMITTER CURRENT

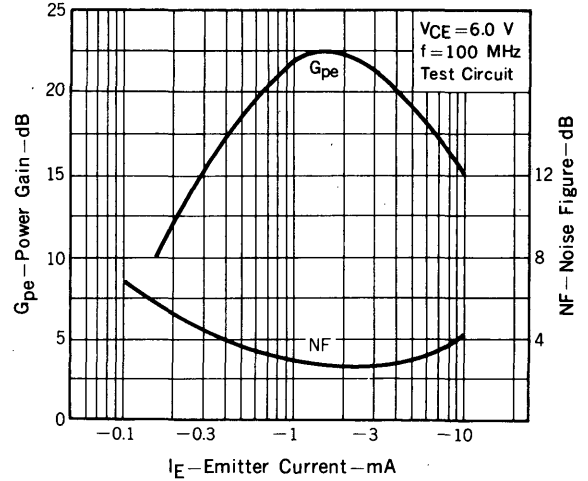

100 MHz  $G_{pe}$ , NF TEST CIRCUIT

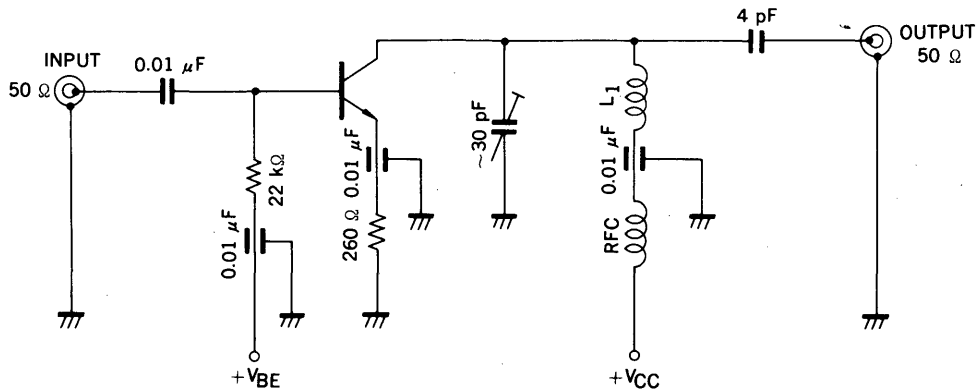



This datasheet has been download from:

[www.datasheetcatalog.com](http://www.datasheetcatalog.com)

Datasheets for electronics components.