

# TC40H008P/F

C<sup>2</sup>MOS DIGITAL INTEGRATED CIRCUIT  
SILICON MONOLITHIC

TC40H008 QUAD 2-INPUT AND GATE

PIN CONNECTION

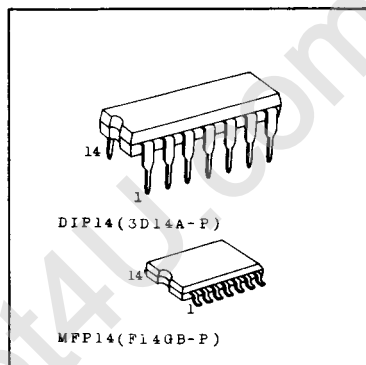
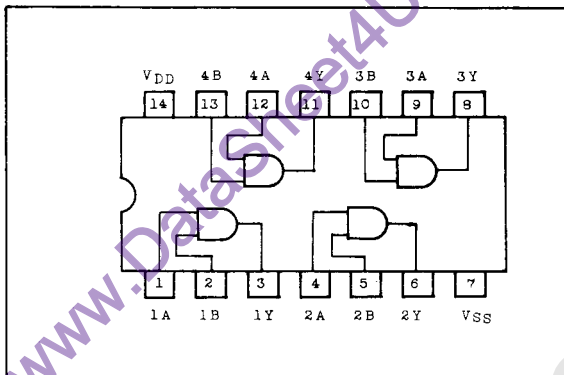

MAXIMUM RATINGS

CHARACTERISTIC	SYMBOL	RATING	UNIT
Supply Voltage	V <sub>DD</sub>	V <sub>SS</sub> -0.5 ~ V <sub>SS</sub> +10	V
Input Voltage	V <sub>IN</sub>	V <sub>SS</sub> -0.5 ~ V <sub>DD</sub> +0.5	V
Output Voltage	V <sub>OUT</sub>	V <sub>SS</sub> -0.5 ~ V <sub>DD</sub> +0.5	V
Input Current	I <sub>IN</sub>	±10	mA
Power Dissipation	P <sub>D</sub>	300 (DIP) / 180 (MFP)	mW
Storage Temperature	T <sub>stg</sub>	-65 ~ 150	°C
Lead Temp./Time	T <sub>sol</sub>	260°C · 10 sec	

TRUTH TABLE

INPUTS		OUTPUTS
A	B	Y
L	L	L
H	L	L
L	H	L
H	H	H

CIRCUIT DIAGRAM

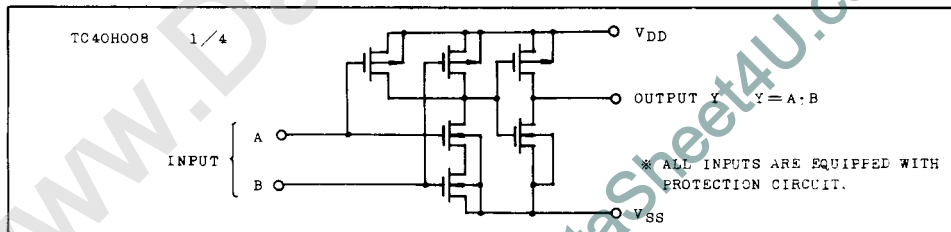
RECOMMENDED OPERATING CONDITIONS (V<sub>SS</sub>=0.0V)

CHARACTERISTIC	SYMBOL	TEST CONDITION	MIN.	TYP.	MAX.	UNIT
Supply Voltage	V <sub>DD</sub>		2.0	-	8.0	V
Input Voltage	V <sub>IN</sub>		0	-	V <sub>DD</sub>	V
Operating Temperature	T <sub>opr</sub>		-40	-	85	°C

## TC40H008P/F

ELECTRICAL CHARACTERISTICS (V<sub>SS</sub>=0.0V)

CHARACTERISTIC	SYMBOL	TEST CONDITION	V <sub>DD</sub> (V)	-40°C		25°C			85°C		UNIT
				MIN.	MAX.	MIN.	TYP.	MAX.	MIN.	MAX.	
High Level Output Voltage	V <sub>OH</sub>	I <sub>OUT</sub>   < 1μA V <sub>IN</sub> =V <sub>DD</sub>	5	4.95	-	4.95	5.0	-	4.95	-	V
Low Level Output Voltage	V <sub>OL</sub>	I <sub>OUT</sub>   < 1μA V <sub>IN</sub> =V <sub>SS</sub> , V <sub>DD</sub>	5	-	0.05	-	0.0	0.05	-	0.05	V
High Level Output Current	I <sub>OH</sub>	V <sub>OH</sub> =4.6V V <sub>IN</sub> =V <sub>DD</sub>	5	-0.52	-	-0.44	-	-	-0.36	-	mA
Low Level Output Current	I <sub>OL</sub>	V <sub>OL</sub> =0.4V V <sub>IN</sub> =V <sub>SS</sub> , V <sub>DD</sub>	5	1.4	-	1.1	-	-	0.8	-	mA
Input Voltage	"H" Level V <sub>IH</sub>	I <sub>OUT</sub>   < 1μA V <sub>OUT</sub> =0.5V V <sub>OUT</sub> =4.5V	5	4.0	-	4.0	-	-	4.0	-	V
	"L" Level V <sub>IL</sub>		5	-	1.0	-	-	1.0	-	1.0	
Input Current	"H" Level I <sub>IH</sub>	V <sub>IH</sub> =8.0V	8	-	0.3	-	10 <sup>-5</sup>	0.3	-	1.0	μA
	"L" Level I <sub>IL</sub>	V <sub>IL</sub> =0.0V	8	-	-0.3	-	-10 <sup>-5</sup>	-0.3	-	-1.0	
Quiescent Supply Current	I <sub>DD</sub>	*V <sub>IN</sub> =V <sub>SS</sub> , V <sub>DD</sub>	5	-	2.0	-	10 <sup>-3</sup>	2.0	-	10.0	μA

\* All valid input combinations.

SWITCHING CHARACTERISTICS (T<sub>a</sub>=25°C, V<sub>SS</sub>=0.0V, C<sub>L</sub>=15pF)

CHARACTERISTIC		SYMBOL	TEST CONDITION	V <sub>DD</sub> (V)	MIN.	TYP.	MAX.	UNIT
Output Rise Time		t <sub>or</sub>	Circuit 1	5	-	20	35	ns
Output Fall Time		t <sub>of</sub>	Circuit 1	5	-	14	30	
Propagation Delay Time	(Low-High)	t <sub>PLH</sub>	Circuit 1	5	-	15	23	ns
	(High-Low)	t <sub>pHL</sub>						
Propagation Delay Time	(Low-High)	t <sub>pLH</sub>	Circuit 2					
	(High-Low)	t <sub>pHL</sub>						
Input Capacitance		C <sub>IN</sub>			-	5	-	pF

## SWITCHING TIME TEST CIRCUIT

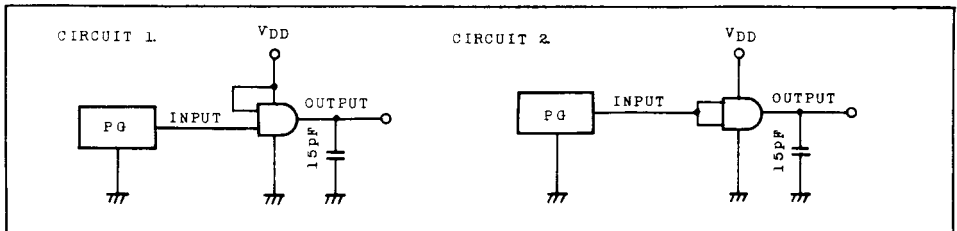

# TC40H008P/F

## SWITCHING TIME TEST WAVEFORM

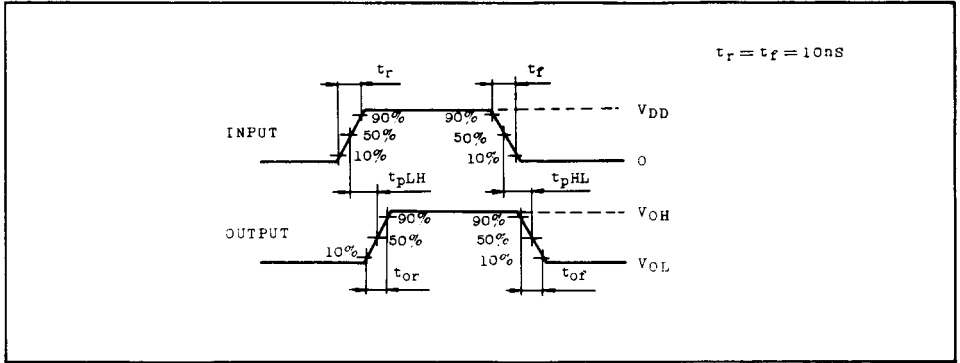

$t_{pd} - V_{DD}$

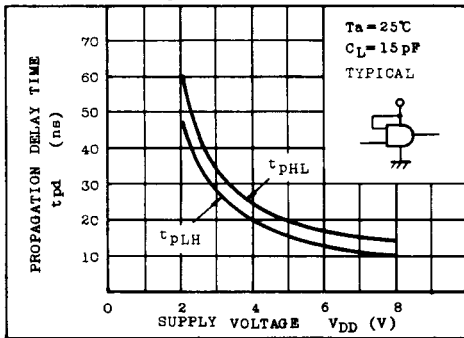

$t_{pd} - C_L$

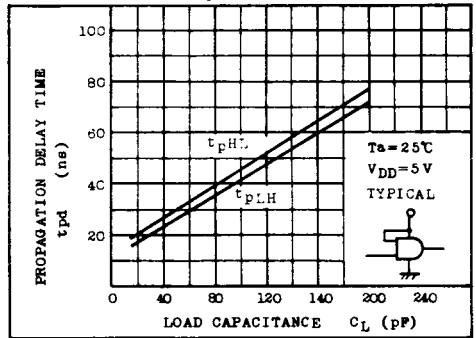

$I_{OL} - V_{OL}$

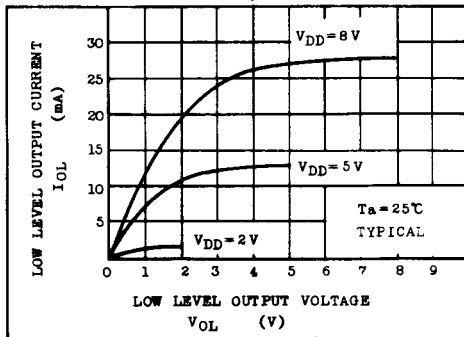

$I_{OH} - (V_{DD} - V_{OH})$

