

# MC10EP139, MC100EP139

## 3.3V / 5V ECL $\div 2/4$ , $\div 4/5/6$ Clock Generation Chip

### Description

The MC10/100EP139 is a low skew  $\div 2/4$ ,  $\div 4/5/6$  clock generation chip designed explicitly for low skew clock generation applications. The internal dividers are synchronous to each other, therefore, the common output edges are all precisely aligned. The device can be driven by either a differential or single-ended ECL or, if positive power supplies are used, LVPECL input signals. In addition, by using the  $V_{BB}$  output, a sinusoidal source can be AC coupled into the device. If a single-ended input is to be used, the  $V_{BB}$  output should be connected to the  $\overline{CLK}$  input and bypassed to ground via a 0.01  $\mu\text{F}$  capacitor.

The common enable ( $\overline{EN}$ ) is synchronous so that the internal dividers will only be enabled/disabled when the internal clock is already in the LOW state. This avoids any chance of generating a runt clock pulse on the internal clock when the device is enabled/disabled as can happen with an asynchronous control. The internal enable flip-flop is clocked on the falling edge of the input clock, therefore, all associated specification limits are referenced to the negative edge of the clock input.

Upon start-up, the internal flip-flops will attain a random state; therefore, for systems which utilize multiple EP139s, the master reset (MR) input must be asserted to ensure synchronization. For systems which only use one EP139, the MR pin need not be exercised as the internal divider design ensures synchronization between the  $\div 2/4$  and the  $\div 4/5/6$  outputs of a single device. All  $V_{CC}$  and  $V_{EE}$  pins must be externally connected to power supply to guarantee proper operation.

The 100 Series contains temperature compensation.

### Features

- Maximum Frequency > 1.0 GHz Typical
- 50 ps Output-to-Output Skew
- PECL Mode Operating Range:  $V_{CC} = 3.0\text{ V}$  to  $5.5\text{ V}$  with  $V_{EE} = 0\text{ V}$
- NECL Mode Operating Range:  $V_{CC} = 0\text{ V}$  with  $V_{EE} = -3.0\text{ V}$  to  $-5.5\text{ V}$
- Open Input Default State
- Safety Clamp on Inputs
- Synchronous Enable/Disable
- Master Reset for Synchronization of Multiple Chips
- $V_{BB}$  Output
- Pb-Free Packages are Available



ON Semiconductor®

<http://onsemi.com>

### MARKING DIAGRAMS\*

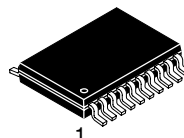

TSSOP-20  
DT SUFFIX  
CASE 948E

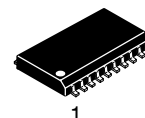
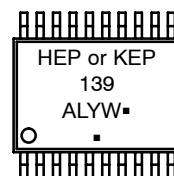

SOIC-20  
DW SUFFIX  
CASE 751D

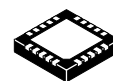
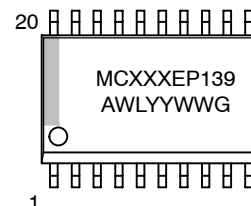

QFN-20  
MN SUFFIX  
CASE 485E



HEP = MC10EP  
KEP = MC100EP  
XXX = 10 or 100  
A = Assembly Location  
L, WL = Wafer Lot  
Y, YY = Year  
W, WW = Work Week  
G or ■ = Pb-Free Package

(Note: Microdot may be in either location)

\*For additional marking information, refer to Application Note AND8002/D.

### ORDERING INFORMATION

See detailed ordering and shipping information in the package dimensions section on page 11 of this data sheet.

# MC10EP139, MC100EP139

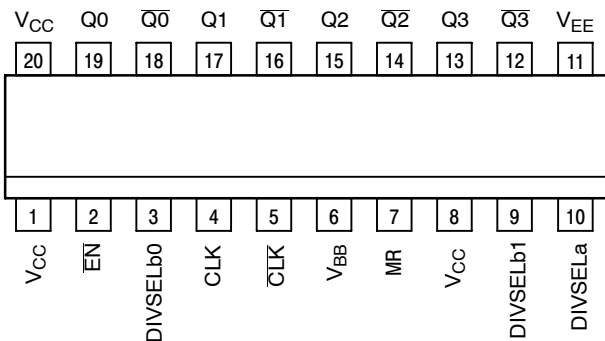

Warning: All V<sub>CC</sub> and V<sub>EE</sub> pins must be externally connected to Power Supply to guarantee proper operation.

Figure 1. 20-Lead Pinout (Top View)

Table 1. PIN DESCRIPTION

PIN	FUNCTION
CLK*, CLK̄*	ECL Differential Clock Inputs
EN̄*	ECL Sync Enable
MR*	ECL Master Reset
V <sub>BB</sub>	ECL Reference Output
Q0, Q1, Q0̄, Q1̄	ECL Differential ÷ 2/4 Outputs
Q2, Q3, Q2̄, Q3̄	ECL Differential ÷ 4/5/6 Outputs
DIVSELa*	ECL Frequency Select Input ÷ 2/4
DIVSELb0*	ECL Frequency Select Input ÷ 4/5/6
DIVSELb1	ECL Frequency Select Input ÷ 4/5/6
V <sub>CC</sub>	ECL Positive Supply
V <sub>EE</sub>	ECL Negative Supply
EP	Exposed Pad

\*Pins will default low when left open.

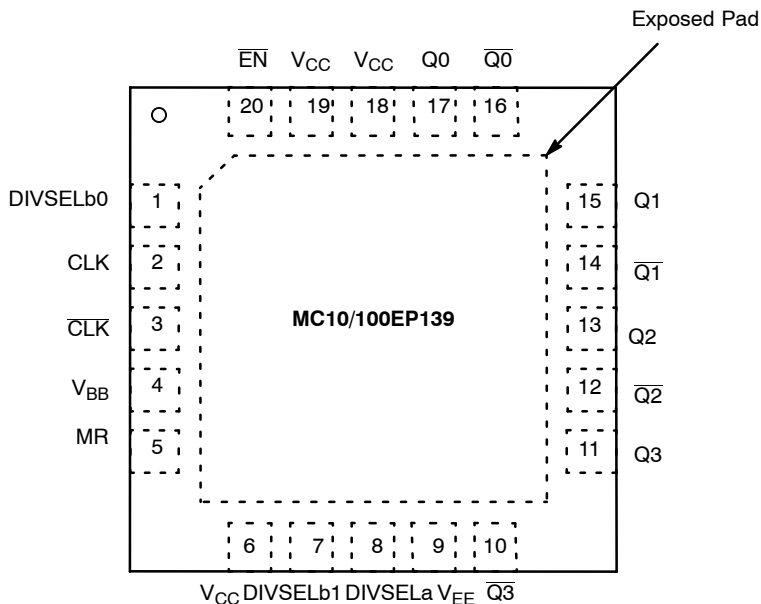

NOTE: The Exposed Pad (EP) on package bottom must be attached to a heat-sinking conduit. The Exposed Pad may only be electrically connected to V<sub>EE</sub>.

Figure 1. QFN-20 Pinout (Top View)

# MC10EP139, MC100EP139

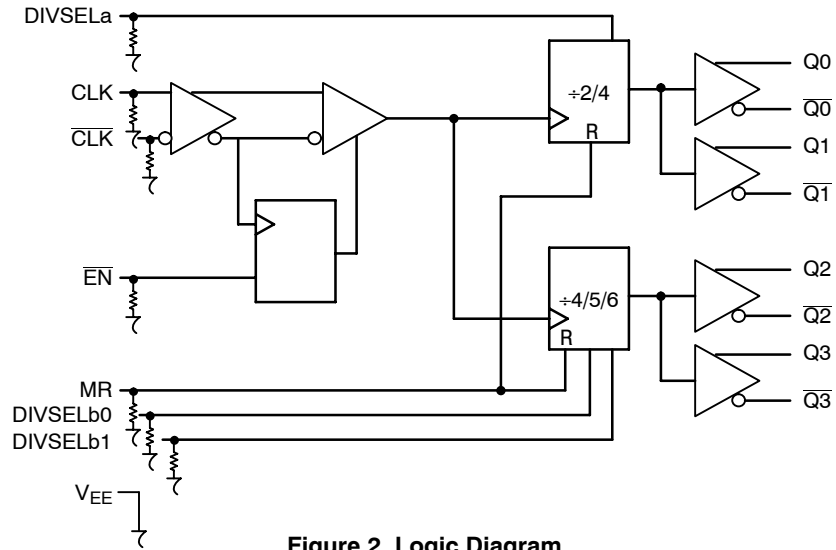

Figure 2. Logic Diagram

Table 2. FUNCTION TABLES

CLK	EN	MR	Function
Z	L	L	Divide
ZZ	H	L	Hold Q0:3
X	X	H	Reset Q0:3

Z = Low-to-High Transition  
 ZZ = High-to-Low Transition

DIVSELa	Q0:1 Outputs	
L	Divide by 2	
H	Divide by 4	
DIVSELb0	DIVSELb1	Q2:3 Outputs
L	L	Divide by 4
H	L	Divide by 6
L	H	Divide by 5
H	H	Divide by 5

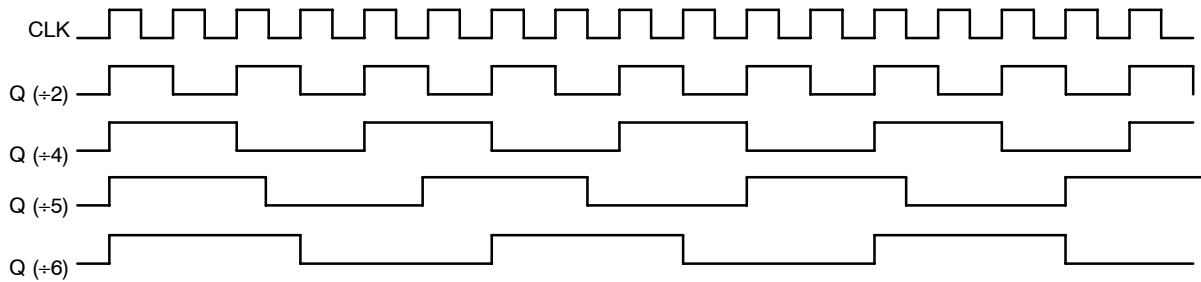

Figure 3. CLK and OUTPUT Timing Diagram

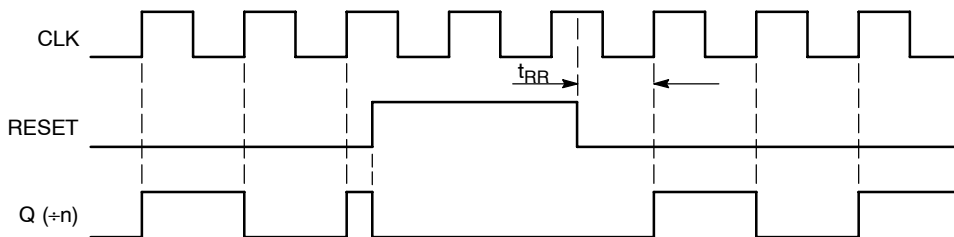

Figure 4. Timing Diagram

# MC10EP139, MC100EP139

**Table 3. ATTRIBUTES**

Characteristics	Value	
Internal Input Pulldown Resistor	75 kΩ	
Internal Input Pullup Resistor	N/A	
ESD Protection	Human Body Model	> 2 kV
	Machine Model	> 100 V
	Charged Device Model	> 2 kV
Moisture Sensitivity, Indefinite Time Out of Drypack (Note 1)	Pb Pkg	Pb-Free Pkg
	SOIC-20	Level 1
	TSSOP-20	Level 1
	QFN-20	N/A
Flammability Rating	Oxygen Index: 28 to 34	UL 94 V-0 @ 0.125 in
Transistor Count	758 Devices	
Meets or exceeds JEDEC Spec EIA/JESD78 IC Latchup Test		

1. For additional information, see Application Note AND8003/D.

**Table 4. MAXIMUM RATINGS**

Symbol	Parameter	Condition 1	Condition 2	Rating	Unit
V <sub>CC</sub>	PECL Mode Power Supply	V <sub>EE</sub> = 0 V		6	V
V <sub>EE</sub>	NECL Mode Power Supply	V <sub>CC</sub> = 0 V		-6	V
V <sub>I</sub>	PECL Mode Input Voltage	V <sub>EE</sub> = 0 V	V <sub>I</sub> ≤ V <sub>CC</sub>	6	V
	NECL Mode Input Voltage	V <sub>CC</sub> = 0 V	V <sub>I</sub> ≥ V <sub>EE</sub>	-6	V
I <sub>out</sub>	Output Current	Continuous		50	mA
		Surge		100	mA
I <sub>BB</sub>	V <sub>BB</sub> Sink/Source			± 0.5	mA
T <sub>A</sub>	Operating Temperature Range			-40 to +85	°C
T <sub>stg</sub>	Storage Temperature Range			-65 to +150	°C
θ <sub>JA</sub>	Thermal Resistance (Junction-to-Ambient)	0 lfpm	TSSOP-20	140	°C/W
		500 lfpm	TSSOP-20	100	°C/W
θ <sub>JC</sub>	Thermal Resistance (Junction-to-Case)	Standard Board	TSSOP-20	23 to 41	°C/W
θ <sub>JA</sub>	Thermal Resistance (Junction-to-Ambient)	0 lfpm	SOIC-20	90	°C/W
		500 lfpm	SOIC-20	60	°C/W
θ <sub>JC</sub>	Thermal Resistance (Junction-to-Case)	Standard Board	SOIC-20	33 to 35	°C/W
θ <sub>JA</sub>	Thermal Resistance (Junction-to-Ambient)	0 lfpm	QFN-20	90	°C/W
		500 lfpm	QFN-20	60	°C/W
θ <sub>JC</sub>	Thermal Resistance (Junction-to-Case)	Standard Board	QFN-20	33 to 35	°C/W
T <sub>sol</sub>	Wave Solder	Pb	<2 to 3 sec @ 248°C	265	°C
		Pb-Free	<2 to 3 sec @ 260°C	265	°C

Stresses exceeding Maximum Ratings may damage the device. Maximum Ratings are stress ratings only. Functional operation above the Recommended Operating Conditions is not implied. Extended exposure to stresses above the Recommended Operating Conditions may affect device reliability.

# MC10EP139, MC100EP139

**Table 5. 10EP DC CHARACTERISTICS, PECL  $V_{CC} = 3.3\text{ V}$ ,  $V_{EE} = 0\text{ V}$  (Note 2)**

Symbol	Characteristic	-40°C			25°C			85°C			Unit
		Min	Typ	Max	Min	Typ	Max	Min	Typ	Max	
$I_{EE}$	Power Supply Current	65	82	105	65	83	105	65	84	105	mA
$V_{OH}$	Output HIGH Voltage (Note 3)	2165	2290	2415	2230	2355	2480	2290	2415	2540	mV
$V_{OL}$	Output LOW Voltage (Note 3)	1365	1490	1615	1430	1555	1680	1490	1615	1740	mV
$V_{IH}$	Input HIGH Voltage (Single-Ended)	2090		2415	2155		2480	2215		2540	mV
$V_{IL}$	Input LOW Voltage (Single-Ended)	1365		1690	1460		1755	1490		1815	mV
$V_{BB}$	Output Voltage Reference	1790	1890	1990	1855	1955	2055	1915	2015	2115	mV
$V_{IHCMR}$	Input HIGH Voltage Common Mode Range (Differential Configuration) (Note 4)	2.0		3.3	2.0		3.3	2.0		3.3	V
$I_{IH}$	Input HIGH Current			150			150			150	$\mu\text{A}$
$I_{IL}$	Input LOW Current	0.5			0.5			0.5			$\mu\text{A}$

NOTE: Device will meet the specifications after thermal equilibrium has been established when mounted in a test socket or printed circuit board with maintained transverse airflow greater than 500 lfpm. Electrical parameters are guaranteed only over the declared operating temperature range. Functional operation of the device exceeding these conditions is not implied. Device specification limit values are applied individually under normal operating conditions and not valid simultaneously.

- Input and output parameters vary 1:1 with  $V_{CC}$ .  $V_{EE}$  can vary +0.3 V to -2.2 V.
- All loading with 50  $\Omega$  to  $V_{CC} - 2.0\text{ V}$ .
- $V_{IHCMR}$  min varies 1:1 with  $V_{EE}$ ,  $V_{IHCMR}$  max varies 1:1 with  $V_{CC}$ . The  $V_{IHCMR}$  range is referenced to the most positive side of the differential input signal.

**Table 6. 10EP DC CHARACTERISTICS, PECL  $V_{CC} = 5.0\text{ V}$ ,  $V_{EE} = 0\text{ V}$  (Note 5)**

Symbol	Characteristic	-40°C			25°C			85°C			Unit
		Min	Typ	Max	Min	Typ	Max	Min	Typ	Max	
$I_{EE}$	Power Supply Current	65	82	105	65	83	105	65	84	105	mA
$V_{OH}$	Output HIGH Voltage (Note 6)	3865	3990	4115	3930	4055	4180	3990	4115	4240	mV
$V_{OL}$	Output LOW Voltage (Note 6)	3065	3190	3315	3130	3255	3380	3190	3315	3440	mV
$V_{IH}$	Input HIGH Voltage (Single-Ended)	3790		4115	3855		4180	3915		4240	mV
$V_{IL}$	Input LOW Voltage (Single-Ended)	3065		3390	3130		3455	3190		3515	mV
$V_{BB}$	Output Voltage Reference	3490	3590	3690	3555	3655	3755	3615	3715	3815	mV
$V_{IHCMR}$	Input HIGH Voltage Common Mode Range (Differential Configuration) (Note 7)	2.0		5.0	2.0		5.0	2.0		5.0	V
$I_{IH}$	Input HIGH Current			150			150			150	$\mu\text{A}$
$I_{IL}$	Input LOW Current	0.5			0.5			0.5			$\mu\text{A}$

NOTE: Device will meet the specifications after thermal equilibrium has been established when mounted in a test socket or printed circuit board with maintained transverse airflow greater than 500 lfpm. Electrical parameters are guaranteed only over the declared operating temperature range. Functional operation of the device exceeding these conditions is not implied. Device specification limit values are applied individually under normal operating conditions and not valid simultaneously.

- Input and output parameters vary 1:1 with  $V_{CC}$ .  $V_{EE}$  can vary +2.0 V to -0.5 V.
- All loading with 50  $\Omega$  to  $V_{CC} - 2.0\text{ V}$ .
- $V_{IHCMR}$  min varies 1:1 with  $V_{EE}$ ,  $V_{IHCMR}$  max varies 1:1 with  $V_{CC}$ . The  $V_{IHCMR}$  range is referenced to the most positive side of the differential input signal.

# MC10EP139, MC100EP139

**Table 7. 10EP DC CHARACTERISTICS, NECL**  $V_{CC} = 0\text{ V}$ ,  $V_{EE} = -5.5\text{ V}$  to  $-3.0\text{ V}$  (Note 8)

Symbol	Characteristic	-40°C			25°C			85°C			Unit
		Min	Typ	Max	Min	Typ	Max	Min	Typ	Max	
$I_{EE}$	Power Supply Current	65	82	105	65	83	105	65	84	105	mA
$V_{OH}$	Output HIGH Voltage (Note 9)	-1135	-1010	-885	-1070	-945	-820	-1010	-885	-760	mV
$V_{OL}$	Output LOW Voltage (Note 9)	-1935	-1810	-1685	-1870	-1745	-1620	-1810	-1685	-1560	mV
$V_{IH}$	Input HIGH Voltage (Single-Ended)	-1210		-885	-1145		-820	-1085		-760	mV
$V_{IL}$	Input LOW Voltage (Single-Ended)	-1935		-1610	-1870		-1545	-1810		-1485	mV
$V_{BB}$	Output Voltage Reference	-1510	-1410	-1310	-1445	-1345	-1245	-1385	-1285	-1185	mV
$V_{IHCMR}$	Input HIGH Voltage Common Mode Range (Differential Configuration) (Note 10)	$V_{EE}+2.0$		0.0	$V_{EE}+2.0$		0.0	$V_{EE}+2.0$		0.0	V
$I_{IH}$	Input HIGH Current			150			150			150	$\mu\text{A}$
$I_{IL}$	Input LOW Current	0.5			0.5			0.5			$\mu\text{A}$

NOTE: Device will meet the specifications after thermal equilibrium has been established when mounted in a test socket or printed circuit board with maintained transverse airflow greater than 500 lfpm. Electrical parameters are guaranteed only over the declared operating temperature range. Functional operation of the device exceeding these conditions is not implied. Device specification limit values are applied individually under normal operating conditions and not valid simultaneously.

8. Input and output parameters vary 1:1 with  $V_{CC}$ .

9. All loading with  $50\ \Omega$  to  $V_{CC} - 2.0\text{ V}$ .

10.  $V_{IHCMR}$  min varies 1:1 with  $V_{EE}$ ,  $V_{IHCMR}$  max varies 1:1 with  $V_{CC}$ . The  $V_{IHCMR}$  range is referenced to the most positive side of the differential input signal.

**Table 8. 100EP DC CHARACTERISTICS, PECL**  $V_{CC} = 3.3\text{ V}$ ,  $V_{EE} = 0\text{ V}$  (Note 11)

Symbol	Characteristic	-40°C			25°C			85°C			Unit
		Min	Typ	Max	Min	Typ	Max	Min	Typ	Max	
$I_{EE}$	Power Supply Current	70	83	100	70	87	105	75	90	110	mA
$V_{OH}$	Output HIGH Voltage (Note 12)	2155	2280	2405	2155	2280	2405	2155	2280	2405	mV
$V_{OL}$	Output LOW Voltage (Note 12)	1355	1480	1605	1355	1480	1605	1355	1480	1605	mV
$V_{IH}$	Input HIGH Voltage (Single-Ended)	2075		2420	2075		2420	2075		2420	mV
$V_{IL}$	Input LOW Voltage (Single-Ended)	1355		1675	1355		1675	1355		1675	mV
$V_{BB}$	Output Voltage Reference	1775	1875	1975	1775	1875	1975	1775	1875	1975	mV
$V_{IHCMR}$	Input HIGH Voltage Common Mode Range (Differential Configuration) (Note 13)	2.0		3.3	2.0		3.3	2.0		3.3	V
$I_{IH}$	Input HIGH Current			150			150			150	$\mu\text{A}$
$I_{IL}$	Input LOW Current	0.5			0.5			0.5			$\mu\text{A}$

NOTE: Device will meet the specifications after thermal equilibrium has been established when mounted in a test socket or printed circuit board with maintained transverse airflow greater than 500 lfpm. Electrical parameters are guaranteed only over the declared operating temperature range. Functional operation of the device exceeding these conditions is not implied. Device specification limit values are applied individually under normal operating conditions and not valid simultaneously.

11. Input and output parameters vary 1:1 with  $V_{CC}$ .  $V_{EE}$  can vary  $+0.3\text{ V}$  to  $-2.2\text{ V}$ .

12. All loading with  $50\ \Omega$  to  $V_{CC} - 2.0\text{ V}$ .

13.  $V_{IHCMR}$  min varies 1:1 with  $V_{EE}$ ,  $V_{IHCMR}$  max varies 1:1 with  $V_{CC}$ . The  $V_{IHCMR}$  range is referenced to the most positive side of the differential input signal.

# MC10EP139, MC100EP139

**Table 9. 100EP DC CHARACTERISTICS, PECL**  $V_{CC} = 5.0\text{ V}$ ,  $V_{EE} = 0\text{ V}$  (Note 14)

Symbol	Characteristic	-40°C			25°C			85°C			Unit
		Min	Typ	Max	Min	Typ	Max	Min	Typ	Max	
$I_{EE}$	Power Supply Current	70	85	100	70	90	105	75	95	110	mA
$V_{OH}$	Output HIGH Voltage (Note 15)	3855	3980	4105	3855	3980	4105	3855	3980	4105	mV
$V_{OL}$	Output LOW Voltage (Note 15)	3055	3180	3305	3055	3180	3305	3055	3180	3305	mV
$V_{IH}$	Input HIGH Voltage (Single-Ended)	3775		4120	3775		4120	3775		4120	mV
$V_{IL}$	Input LOW Voltage (Single-Ended)	3055		3375	3055		3375	3055		3375	mV
$V_{BB}$	Output Voltage Reference	3475	3575	3675	3475	3575	3675	3475	3575	3675	mV
$V_{IHCMR}$	Input HIGH Voltage Common Mode Range (Differential Configuration) (Note 16)	2.0		5.0	2.0		5.0	2.0		5.0	V
$I_{IH}$	Input HIGH Current			150			150			150	$\mu\text{A}$
$I_{IL}$	Input LOW Current	0.5			0.5			0.5			$\mu\text{A}$

NOTE: Device will meet the specifications after thermal equilibrium has been established when mounted in a test socket or printed circuit board with maintained transverse airflow greater than 500 lfpm. Electrical parameters are guaranteed only over the declared operating temperature range. Functional operation of the device exceeding these conditions is not implied. Device specification limit values are applied individually under normal operating conditions and not valid simultaneously.

14. Input and output parameters vary 1:1 with  $V_{CC}$ .  $V_{EE}$  can vary +2.0 V to -0.5 V.

15. All loading with 50  $\Omega$  to  $V_{CC} - 2.0\text{ V}$ .

16.  $V_{IHCMR}$  min varies 1:1 with  $V_{EE}$ ,  $V_{IHCMR}$  max varies 1:1 with  $V_{CC}$ . The  $V_{IHCMR}$  range is referenced to the most positive side of the differential input signal.

**Table 10. 100EP DC CHARACTERISTICS, NECL**  $V_{CC} = 0\text{ V}$ ,  $V_{EE} = -5.5\text{ V}$  to  $-3.0\text{ V}$  (Note 17)

Symbol	Characteristic	-40°C			25°C			85°C			Unit
		Min	Typ	Max	Min	Typ	Max	Min	Typ	Max	
$I_{EE}$	Power Supply Current	70	85	100	70	90	105	75	95	110	mA
$V_{OH}$	Output HIGH Voltage (Note 18)	-1145	-1020	-895	-1145	-1020	-895	-1145	-1020	-895	mV
$V_{OL}$	Output LOW Voltage (Note 18)	-1945	-1820	-1695	-1945	-1820	-1695	-1945	-1820	-1695	mV
$V_{IH}$	Input HIGH Voltage (Single-Ended)	-1225		-880	-1225		-880	-1225		-880	mV
$V_{IL}$	Input LOW Voltage (Single-Ended)	-1945		-1625	-1945		-1625	-1945		-1625	mV
$V_{BB}$	Output Voltage Reference	-1525	-1425	-1325	-1525	-1425	-1325	-1525	-1425	-1325	mV
$V_{IHCMR}$	Input HIGH Voltage Common Mode Range (Differential Configuration) (Note 19)	$V_{EE}+2.0$		0.0	$V_{EE}+2.0$		0.0	$V_{EE}+2.0$		0.0	V
$I_{IH}$	Input HIGH Current			150			150			150	$\mu\text{A}$
$I_{IL}$	Input LOW Current	0.5			0.5			0.5			$\mu\text{A}$

NOTE: Device will meet the specifications after thermal equilibrium has been established when mounted in a test socket or printed circuit board with maintained transverse airflow greater than 500 lfpm. Electrical parameters are guaranteed only over the declared operating temperature range. Functional operation of the device exceeding these conditions is not implied. Device specification limit values are applied individually under normal operating conditions and not valid simultaneously.

17. Input and output parameters vary 1:1 with  $V_{CC}$ .

18. All loading with 50  $\Omega$  to  $V_{CC} - 2.0\text{ V}$ .

19.  $V_{IHCMR}$  min varies 1:1 with  $V_{EE}$ ,  $V_{IHCMR}$  max varies 1:1 with  $V_{CC}$ . The  $V_{IHCMR}$  range is referenced to the most positive side of the differential input signal.

# MC10EP139, MC100EP139

**Table 11. AC CHARACTERISTICS**  $V_{CC} = 0\text{ V}$ ;  $V_{EE} = -3.0\text{ V}$  to  $-5.5\text{ V}$  or  $V_{CC} = 3.0\text{ V}$  to  $5.5\text{ V}$ ;  $V_{EE} = 0\text{ V}$  (Note 20)

Symbol	Characteristic	-40°C			25°C			85°C			Unit
		Min	Typ	Max	Min	Typ	Max	Min	Typ	Max	
$f_{max}$	Maximum Frequency (See Figure 5 $F_{max}/JITTER$ )		> 1			> 1			> 1		GHz
$t_{PLH}$ , $t_{PHL}$	Propagation Delay CLK, Q (Diff) MR, Q	550 700	700 800	800 900	600 700	750 850	900 1000	675 800	825 950	975 1100	ps
$t_{RR}$	Reset Recovery	200	100		200	100		200	100		ps
$t_s$	Setup Time $\overline{EN}$ , $\overline{CLK}$ DIVSEL, CLK	200 400	120 180		200 400	120 180		200 400	120 180		ps
$t_h$	Hold Time CLK, $\overline{EN}$ CLK, DIVSEL	100 200	50 140		100 200	50 140		100 200	50 140		ps
$t_{PW}$	Minimum Pulse Width MR	550	450		550	450		550	450		ps
$t_{SKEW}$	Within Device Skew Q, $\overline{Q}$ Device-to-Device Skew (Note 21)		50 200	100 300		50 200	100 300		50 200	100 300	ps
$t_{JITTER}$	Random Clock Jitter (RMS) (See Figure 5 $F_{max}/JITTER$ )		0.2	< 1.0		0.2	< 1.0		0.2	< 1.5	ps
$V_{PP}$	Input Voltage Swing (Differential Configuration)	150	800	1200	150	800	1200	150	800	1200	mV
$t_r$ $t_f$	Output Rise/Fall Times (20% – 80%) Q, $\overline{Q}$	110	180	250	125	190	275	150	215	300	ps

NOTE: Device will meet the specifications after thermal equilibrium has been established when mounted in a test socket or printed circuit board with maintained transverse airflow greater than 500 lfpm. Electrical parameters are guaranteed only over the declared operating temperature range. Functional operation of the device exceeding these conditions is not implied. Device specification limit values are applied individually under normal operating conditions and not valid simultaneously.

20. Measured using a 750 mV source, 50% duty cycle clock source. All loading with  $50\ \Omega$  to  $V_{CC} - 2.0\text{ V}$ .

21. Skew is measured between outputs under identical transitions. Duty cycle skew is defined only for differential operation when the delays are measured from the cross point of the inputs to the cross point of the outputs.



MC10EP139, MC100EP139

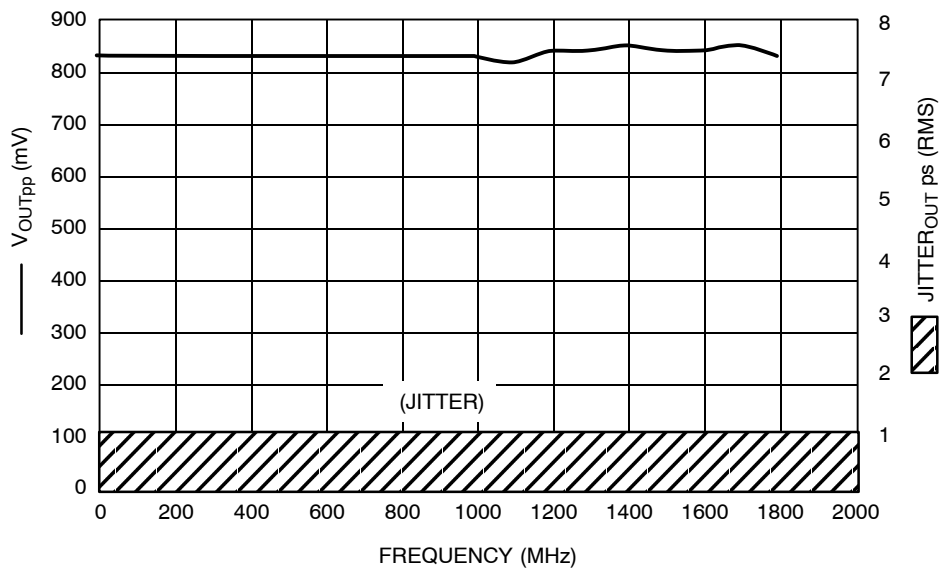

Figure 5.  $\div 2, F_{max}/Jitter$

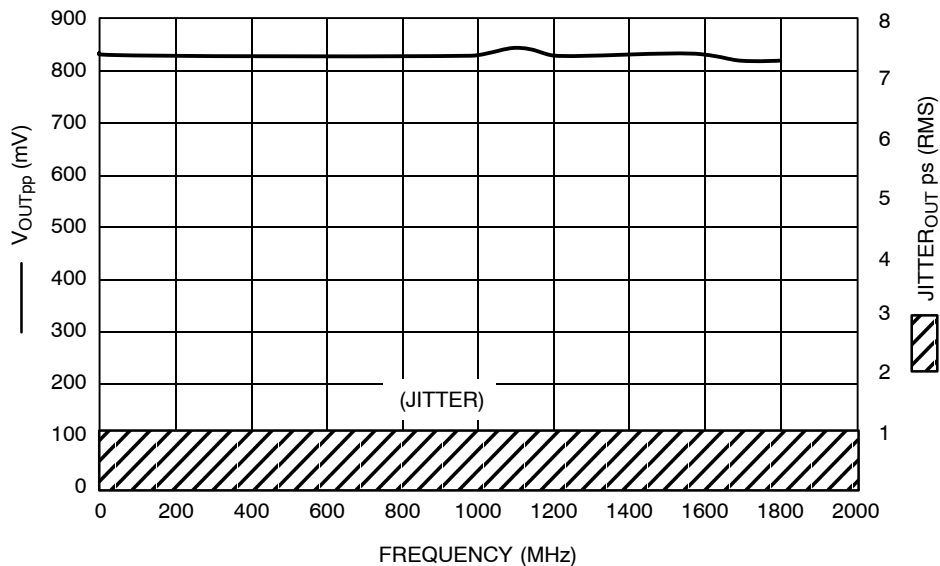

Figure 6.  $\div 5, F_{max}/Jitter$

# MC10EP139, MC100EP139

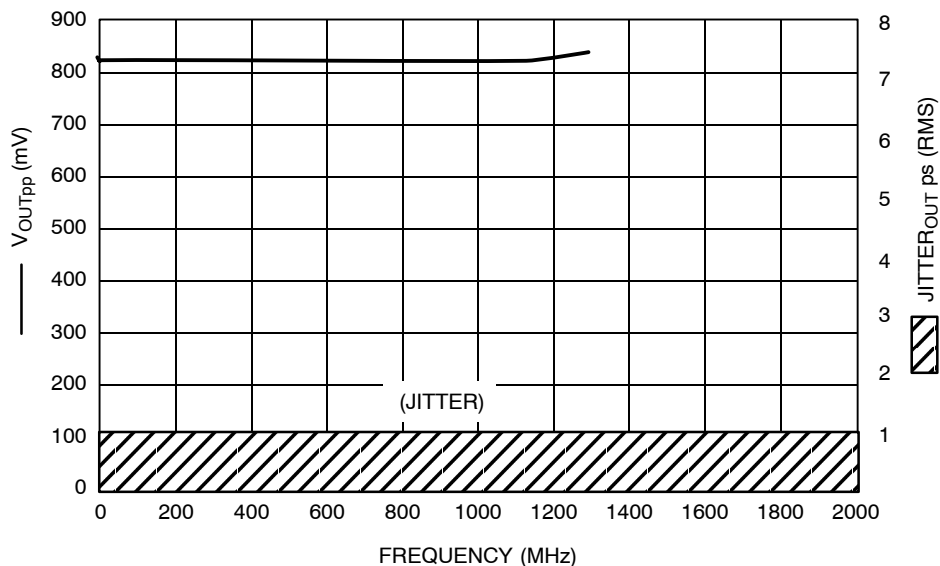

Figure 7.  $\div 4, F_{max}/Jitter$

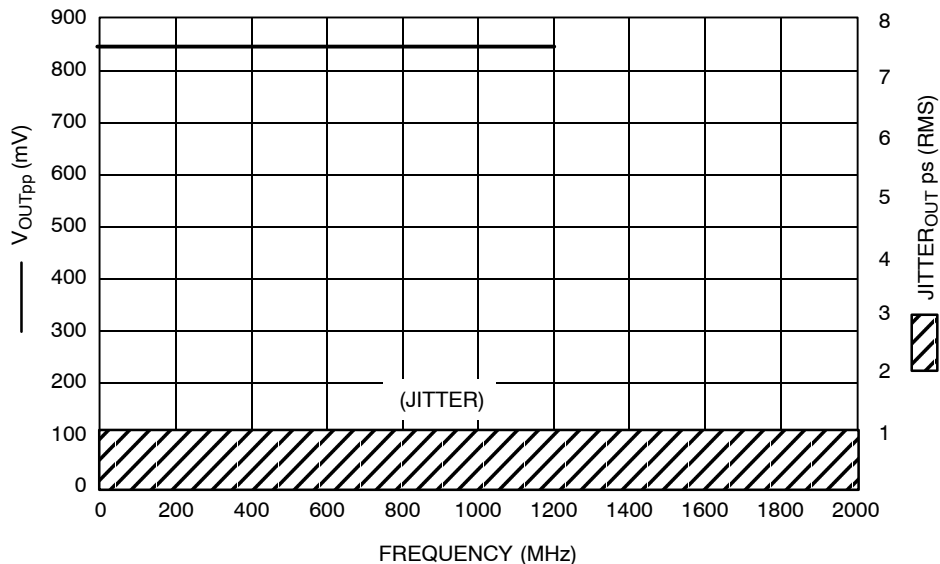

Figure 8.  $\div 6, F_{max}/Jitter$

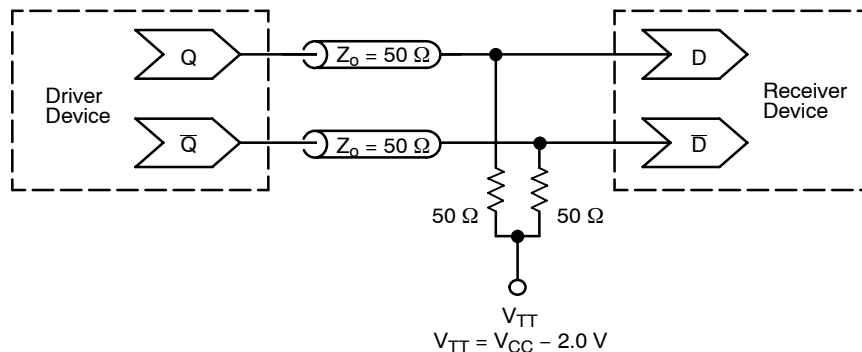

Figure 9. Typical Termination for Output Driver and Device Evaluation (See Application Note AND8020/D – Termination of ECL Logic Devices.)

## MC10EP139, MC100EP139

### ORDERING INFORMATION

Device	Package	Shipping†
MC10EP139DT	TSSOP-20*	75 Units / Rail
MC10EP139DTG	TSSOP-20*	75 Units / Rail
MC10EP139DTR2	TSSOP-20*	2500 / Tape & Reel
MC10EP139DTR2G	TSSOP-20*	2500 / Tape & Reel
MC10EP139DW	SOIC-20	38 Units / Rail
MC10EP139DWG	SOIC-20 (Pb-Free)	38 Units / Rail
MC10EP139DWR2	SOIC-20	1000 / Tape & Reel
MC10EP139DWR2G	SOIC-20 (Pb-Free)	1000 / Tape & Reel
MC10EP139MNG	QFN-20 (Pb-Free)	92 Units / Rail
MC10EP139MNTXG	QFN-20 (Pb-Free)	3000 / Tape & Reel
MC100EP139DT	TSSOP-20*	75 Units / Rail
MC100EP139DTG	TSSOP-20*	75 Units / Rail
MC100EP139DTR2	TSSOP-20*	2500 / Tape & Reel
MC100EP139DTR2G	TSSOP-20*	2500 / Tape & Reel
MC100EP139DW	SOIC-20	38 Units / Rail
MC100EP139DWG	SOIC-20 (Pb-Free)	38 Units / Rail
MC100EP139DWR2	SOIC-20	1000 / Tape & Reel
MC100EP139DWR2G	SOIC-20 (Pb-Free)	1000 / Tape & Reel
MC100EP139MNG	QFN-20 (Pb-Free)	92 Units / Rail
MC100EP139MNTXG	QFN-20 (Pb-Free)	3000 / Tape & Reel

†For information on tape and reel specifications, including part orientation and tape sizes, please refer to our Tape and Reel Packaging Specifications Brochure, BRD8011/D.

\*This package is inherently Pb-Free.

#### Resource Reference of Application Notes

- AN1405/D** – ECL Clock Distribution Techniques
- AN1406/D** – Designing with PECL (ECL at +5.0 V)
- AN1503/D** – ECLinPS™ I/O SPICE Modeling Kit
- AN1504/D** – Metastability and the ECLinPS Family
- AN1568/D** – Interfacing Between LVDS and ECL
- AN1672/D** – The ECL Translator Guide
- AND8001/D** – Odd Number Counters Design
- AND8002/D** – Marking and Date Codes
- AND8020/D** – Termination of ECL Logic Devices
- AND8066/D** – Interfacing with ECLinPS
- AND8090/D** – AC Characteristics of ECL Devices

# MC10EP139, MC100EP139

## PACKAGE DIMENSIONS

TSSOP-20  
CASE 948E-02  
ISSUE C

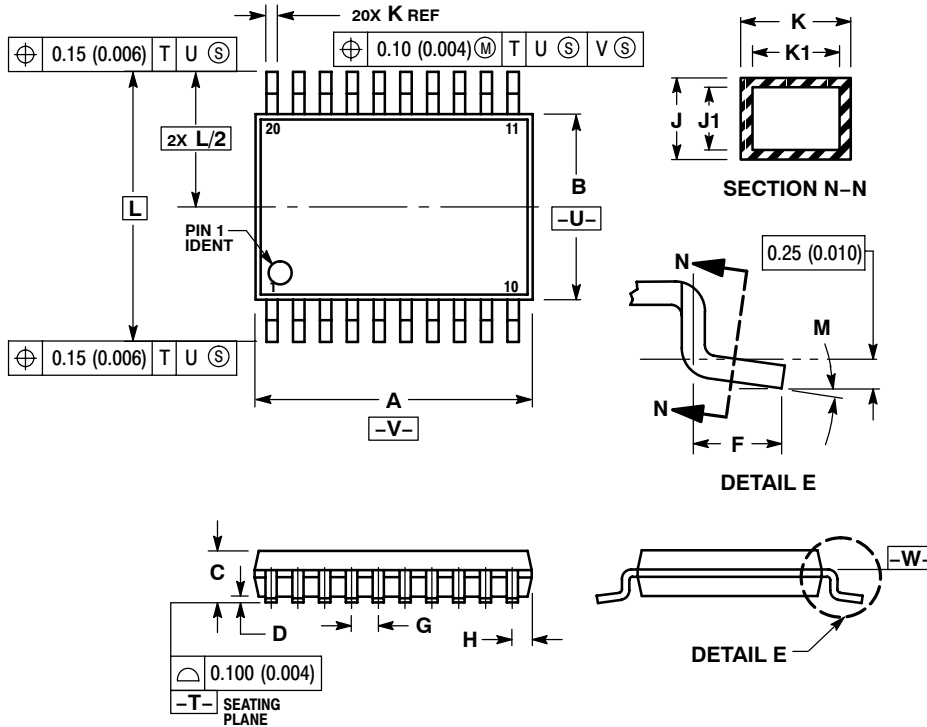

### NOTES:

1. DIMENSIONING AND TOLERANCING PER ANSI Y14.5M, 1982.
2. CONTROLLING DIMENSION: MILLIMETER.
3. DIMENSION A DOES NOT INCLUDE MOLD FLASH, PROTRUSIONS OR GATE BURRS. MOLD FLASH OR GATE BURRS SHALL NOT EXCEED 0.15 (0.006) PER SIDE.
4. DIMENSION B DOES NOT INCLUDE INTERLEAD FLASH OR PROTRUSION. INTERLEAD FLASH OR PROTRUSION SHALL NOT EXCEED 0.25 (0.010) PER SIDE.
5. DIMENSION K DOES NOT INCLUDE DAMBAR PROTRUSION. ALLOWABLE DAMBAR PROTRUSION SHALL BE 0.08 (0.003) TOTAL IN EXCESS OF THE K DIMENSION AT MAXIMUM MATERIAL CONDITION.
6. TERMINAL NUMBERS ARE SHOWN FOR REFERENCE ONLY.
7. DIMENSION A AND B ARE TO BE DETERMINED AT DATUM PLANE -W-.

DIM	MILLIMETERS		INCHES	
	MIN	MAX	MIN	MAX
A	6.40	6.60	0.252	0.260
B	4.30	4.50	0.169	0.177
C	---	1.20	---	0.047
D	0.05	0.15	0.002	0.006
F	0.50	0.75	0.020	0.030
G	0.65 BSC		0.026 BSC	
H	0.27	0.37	0.011	0.015
J	0.09	0.20	0.004	0.008
J1	0.09	0.16	0.004	0.006
K	0.19	0.30	0.007	0.012
K1	0.19	0.25	0.007	0.010
L	6.40 BSC		0.252 BSC	
M	0°	8°	0°	8°

### SOLDERING FOOTPRINT\*

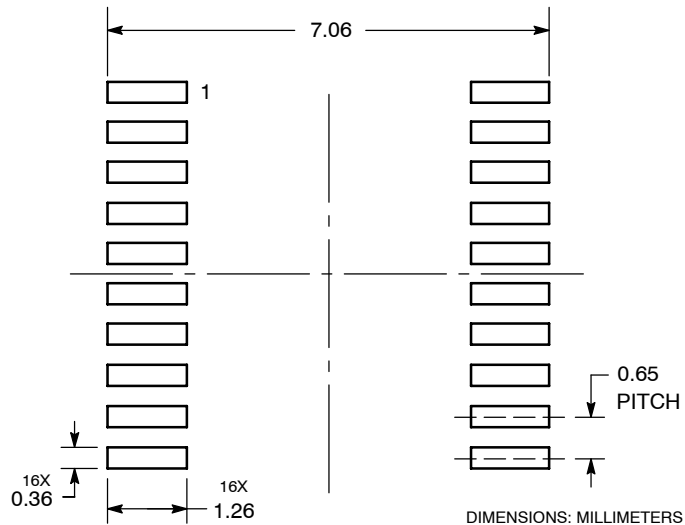

\*For additional information on our Pb-Free strategy and soldering details, please download the ON Semiconductor Soldering and Mounting Techniques Reference Manual, SOLDERRM/D.

# MC10EP139, MC100EP139

## PACKAGE DIMENSIONS

SOIC-20  
DW SUFFIX  
PLASTIC SOIC PACKAGE  
CASE 751D-05  
ISSUE G

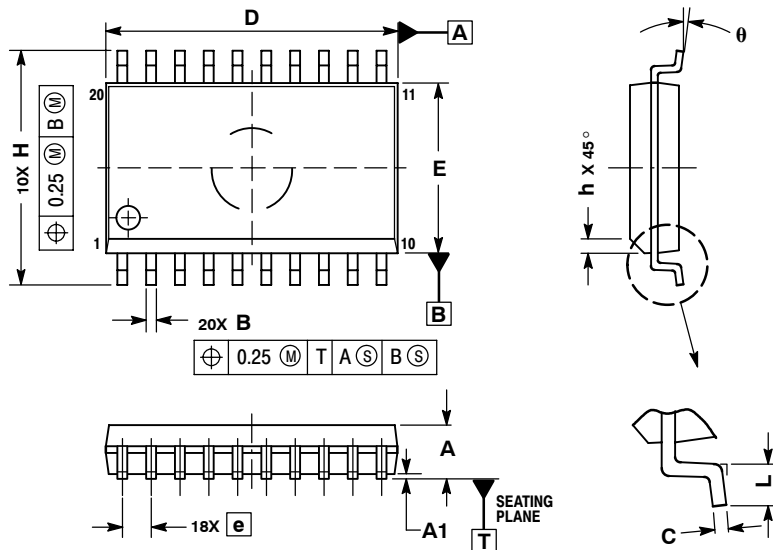

NOTES:

1. DIMENSIONS ARE IN MILLIMETERS.
2. INTERPRET DIMENSIONS AND TOLERANCES PER ASME Y14.5M, 1994.
3. DIMENSIONS D AND E DO NOT INCLUDE MOLD PROTRUSION.
4. MAXIMUM MOLD PROTRUSION 0.15 PER SIDE.
5. DIMENSION B DOES NOT INCLUDE DAMBAR PROTRUSION. ALLOWABLE PROTRUSION SHALL BE 0.13 TOTAL IN EXCESS OF B DIMENSION AT MAXIMUM MATERIAL CONDITION.

MILLIMETERS	
DIM	MIN MAX
A	2.35 2.65
A1	0.10 0.25
B	0.35 0.49
C	0.23 0.32
D	12.65 12.95
E	7.40 7.60
e	1.27 BSC
H	10.05 10.55
h	0.25 0.75
L	0.50 0.90
theta	0° 7°

# MC10EP139, MC100EP139

## PACKAGE DIMENSIONS

QFN-20  
CASE 485E-01  
ISSUE O

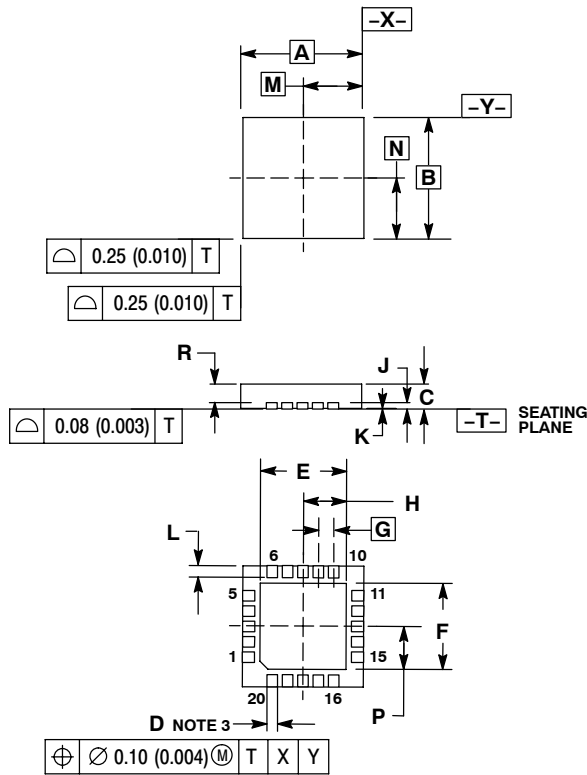

### NOTES:

1. DIMENSIONING AND TOLERANCING PER ANSI Y14.5M, 1982.
2. CONTROLLING DIMENSION: MILLIMETERS.
3. DIMENSION D APPLIES TO PLATED TERMINAL AND IS MEASURED BETWEEN 0.25 AND 0.30 MM FROM TERMINAL.
4. COPLANARITY APPLIES TO THE EXPOSED PAD AS WELL AS THE TERMINALS.

DIM	MILLIMETERS		INCHES	
	MIN	MAX	MIN	MAX
A	4.00 BSC		0.157 BSC	
B	4.00 BSC		0.157 BSC	
C	0.80	1.00	0.031	0.039
D	0.23	0.35	0.009	0.014
E	2.75	2.85	0.108	0.112
F	2.75	2.85	0.108	0.112
G	0.50 BSC		0.020 BSC	
H	1.38	1.43	0.054	0.056
J	0.20 REF		0.008 REF	
K	0.00	0.05	0.000	0.002
L	0.35	0.45	0.014	0.018
M	2.00 BSC		0.079 BSC	
N	2.00 BSC		0.079 BSC	
P	1.38	1.43	0.054	0.056
R	0.60	0.80	0.024	0.031

ECLinPS is a trademark of Semiconductor Components Industries, LLC (SCILLC).

**ON Semiconductor** and **ON** are registered trademarks of Semiconductor Components Industries, LLC (SCILLC). SCILLC reserves the right to make changes without further notice to any products herein. SCILLC makes no warranty, representation or guarantee regarding the suitability of its products for any particular purpose, nor does SCILLC assume any liability arising out of the application or use of any product or circuit, and specifically disclaims any and all liability, including without limitation special, consequential or incidental damages. "Typical" parameters which may be provided in SCILLC data sheets and/or specifications can and do vary in different applications and actual performance may vary over time. All operating parameters, including "Typicals" must be validated for each customer application by customer's technical experts. SCILLC does not convey any license under its patent rights nor the rights of others. SCILLC products are not designed, intended, or authorized for use as components in systems intended for surgical implant into the body, or other applications intended to support or sustain life, or for any other application in which the failure of the SCILLC product could create a situation where personal injury or death may occur. Should Buyer purchase or use SCILLC products for any such unintended or unauthorized application, Buyer shall indemnify and hold SCILLC and its officers, employees, subsidiaries, affiliates, and distributors harmless against all claims, costs, damages, and expenses, and reasonable attorney fees arising out of, directly or indirectly, any claim of personal injury or death associated with such unintended or unauthorized use, even if such claim alleges that SCILLC was negligent regarding the design or manufacture of the part. SCILLC is an Equal Opportunity/Affirmative Action Employer. This literature is subject to all applicable copyright laws and is not for resale in any manner.

### PUBLICATION ORDERING INFORMATION

**LITERATURE FULFILLMENT:**  
Literature Distribution Center for ON Semiconductor  
P.O. Box 5163, Denver, Colorado 80217 USA  
**Phone:** 303-675-2175 or 800-344-3860 Toll Free USA/Canada  
**Fax:** 303-675-2176 or 800-344-3867 Toll Free USA/Canada  
**Email:** orderlit@onsemi.com

**N. American Technical Support:** 800-282-9855 Toll Free  
USA/Canada  
**Europe, Middle East and Africa Technical Support:**  
Phone: 421 33 790 2910  
**Japan Customer Focus Center**  
Phone: 81-3-5773-3850

**ON Semiconductor Website:** [www.onsemi.com](http://www.onsemi.com)  
**Order Literature:** <http://www.onsemi.com/orderlit>

For additional information, please contact your local Sales Representative