

2SK3516-01L,S,SJ

FUJI POWER MOSFET Super FAP-G Series

N-CHANNEL SILICON POWER MOSFET

■ Features

- High speed switching
- Low on-resistance
- No secondary breakdown
- Low driving power
- Avalanche-proof

■ Applications

- Switching regulators
- UPS (Uninterruptible Power Supply)
- DC-DC converters

■ Maximum ratings and characteristic Absolute maximum ratings

● (Tc=25°C unless otherwise specified)

Item	Symbol	Ratings	Unit
Drain-source voltage	V _{DS}	450	V
Continuous drain current	I _D	±8	A
Pulsed drain current	I _{D(puls)}	±32	A
Gate-source voltage	V _{GS}	±30	V
Repetitive or non-repetitive	IAR *2	8	A
Maximum Avalanche Energy	EAS *1	193	mJ
Maximum Drain-Source dV/dt	dV _{DS} /dt *4	20	kV/μs
Peak Diode Recovery dV/dt	dV/dt *3	5	kV/μs
Max. power dissipation	P _D	T _a =25°C	1.67
		T _c =25°C	65
Operating and storage temperature range	T _{ch}	+150	°C
	T _{stg}	-55 to +150	°C

*1 L=5.53mH, V_{CC}=45V *2 T_{ch}≤150°C *3 I_F≤-I_D, -di/dt=50A/μs, V_{CC}≤BV_{DS}, T_{ch}≤150°C
*4 V_{DS}≤450V

● Electrical characteristics (T_c =25°C unless otherwise specified)

Item	Symbol	Test Conditions	Min.	Typ.	Max.	Units
Drain-source breakdown voltage	V _{(BR)DSS}	I _D =250μA V _{GS} =0V	450			V
Gate threshold voltage	V _{GS(th)}	I _D =250μA V _{DS} =V _{GS}	3.0		5.0	V
Zero gate voltage drain current	I _{DSS}	V _{DS} =450V V _{GS} =0V V _{DS} =360V V _{GS} =0V	T _{ch} =25°C		25	μA
			T _{ch} =125°C		250	
Gate-source leakage current	I _{GSS}	V _{GS} =±30V V _{DS} =0V		10	100	nA
Drain-source on-state resistance	R _{DS(on)}	I _D =4A V _{GS} =10V		0.50	0.65	Ω
Forward transconductance	g _{fs}	I _D =4A V _{DS} =25V	4	8		S
Input capacitance	C _{iss}	V _{DS} =25V V _{GS} =0V f=1MHz		800	1200	pF
Output capacitance	C _{oss}			120	150	
Reverse transfer capacitance	C _{rss}			4.5	7	
Turn-on time t _{on}	td(on)	V _{CC} =300V I _D =4A V _{GS} =10V		15	23	ns
	tr			12	18	
Turn-off time t _{off}	td(off)	R _{GS} =10Ω		25	38	ns
	tr			7	11	
Total Gate Charge	Q _G	V _{CC} =225V		22	33	nC
Gate-Source Charge	Q _{GS}	I _D =8A		9.5	14.5	
Gate-Drain Charge	Q _{GD}	V _{GS} =10V		6.5	10	
Avalanche capability	I _{AV}	L=5.53mH T _{ch} =25°C	8			A
Diode forward on-voltage	V _{SD}	I _F =8A V _{GS} =0V T _{ch} =25°C		1.00	1.50	V
Reverse recovery time	t _{rr}	I _F =8A V _{GS} =0V		0.7		μs
Reverse recovery charge	Q _{rr}	-di/dt=100A/μs T _{ch} =25°C		3.5		μC

● Thermal characteristics

Item	Symbol	Test Conditions	Min.	Typ.	Max.	Units
Thermal resistance	R _{th(ch-c)}	channel to case			1.92	°C/W
	R _{th(ch-a)}	channel to ambient			75.0	°C/W

■ Outline Drawings

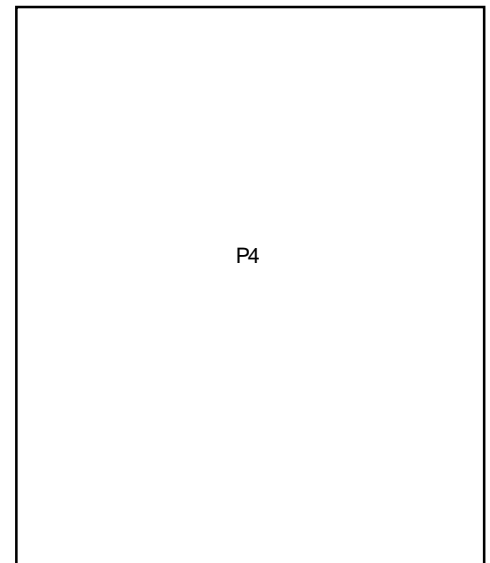

■ Equivalent circuit schematic

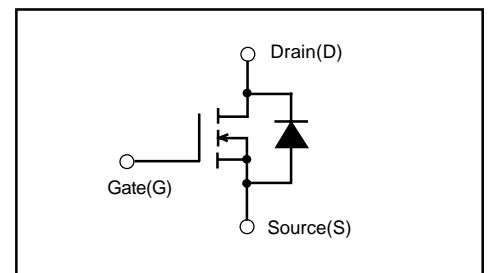

Characteristics

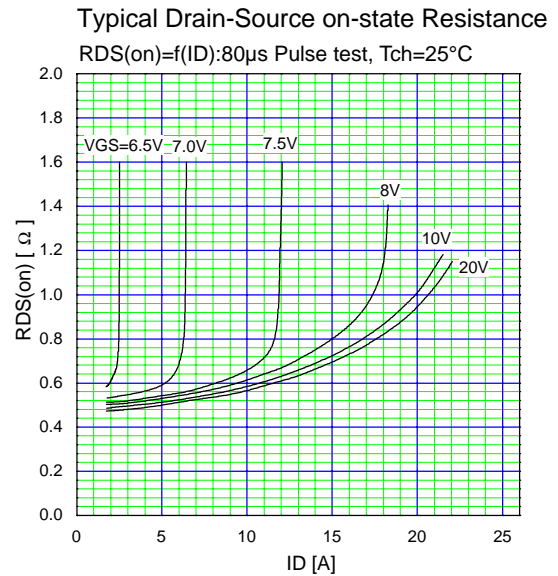
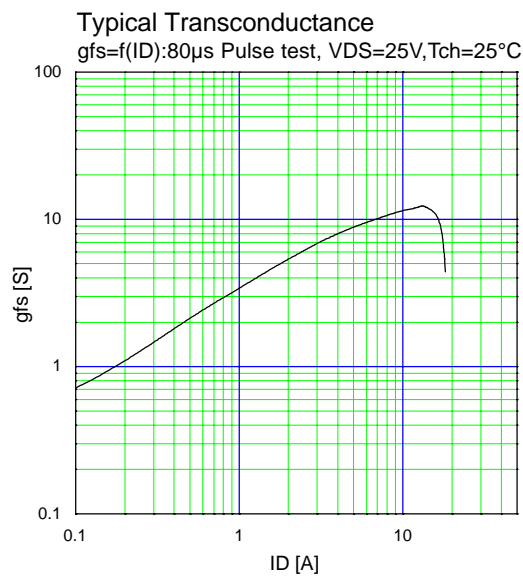
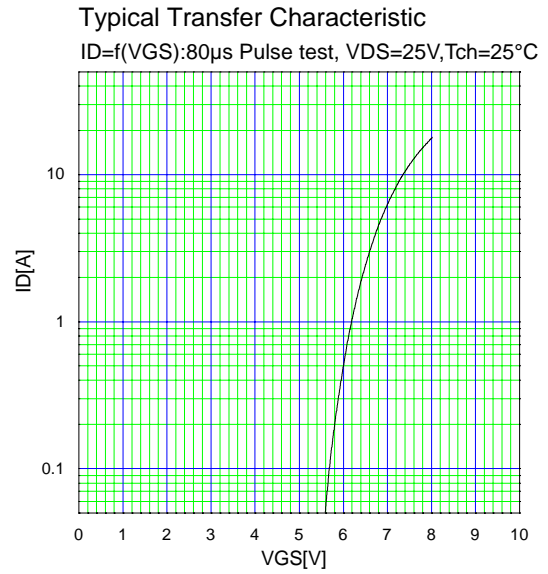
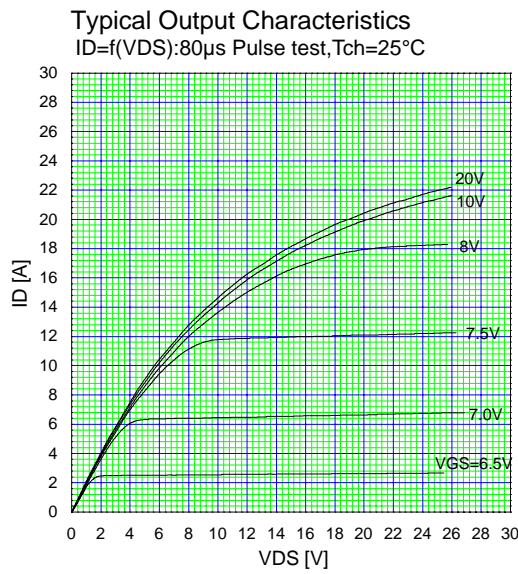
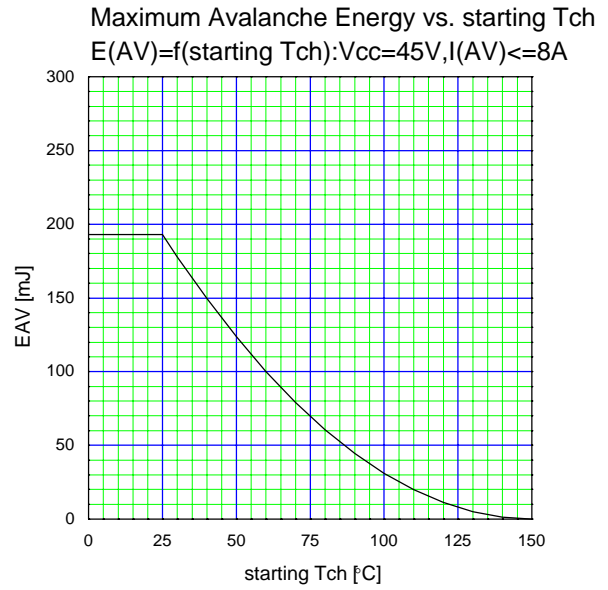
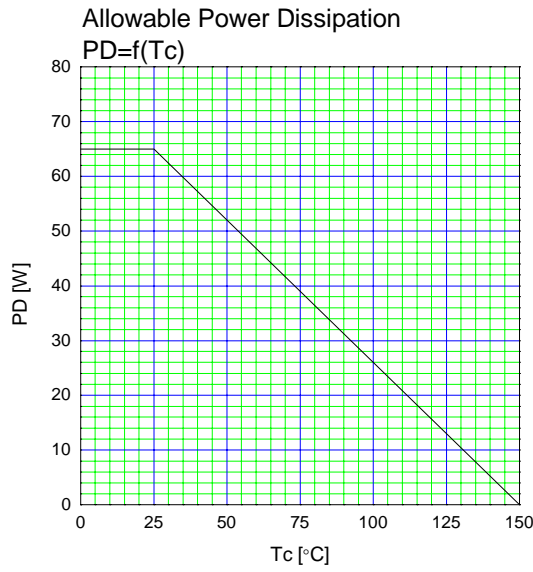

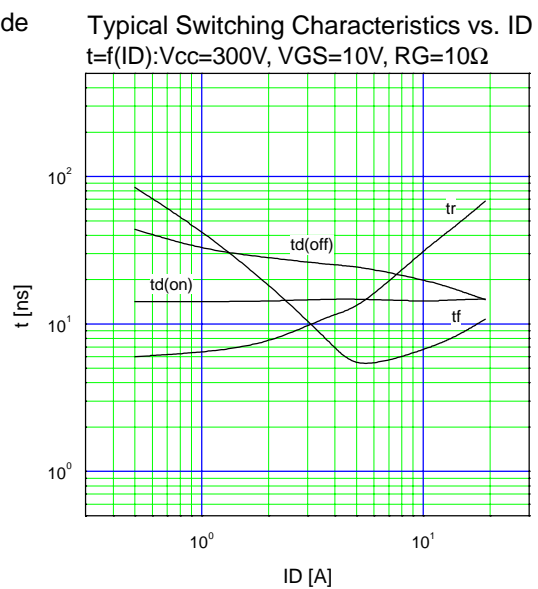
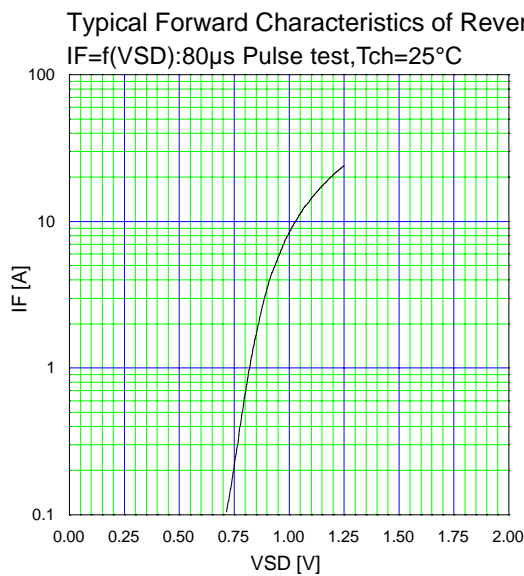
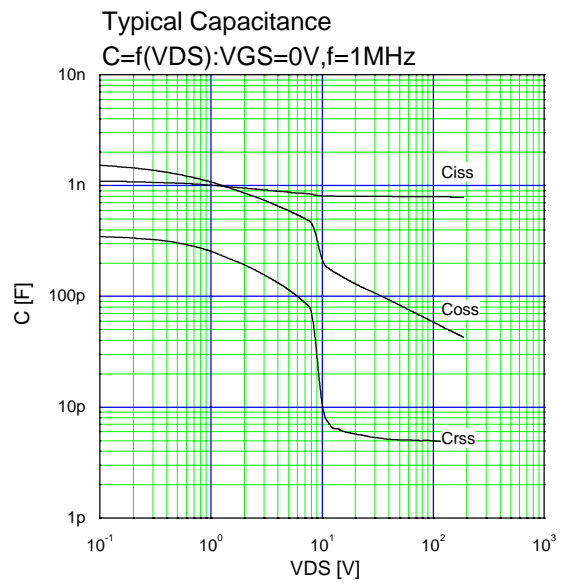
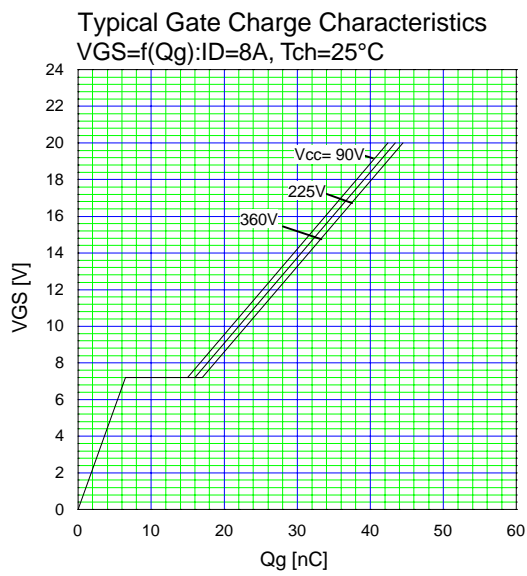
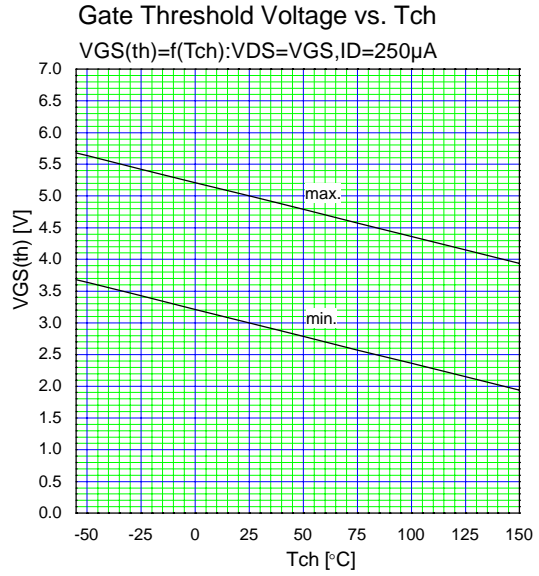
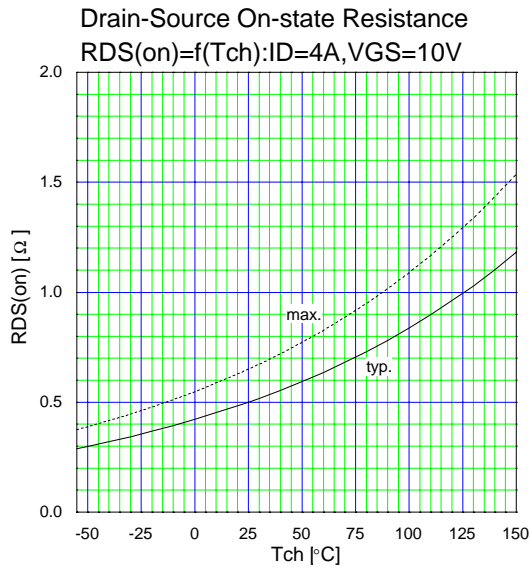

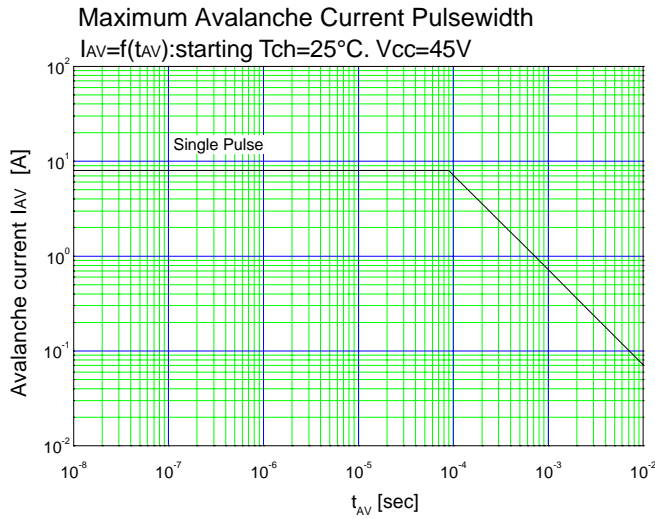
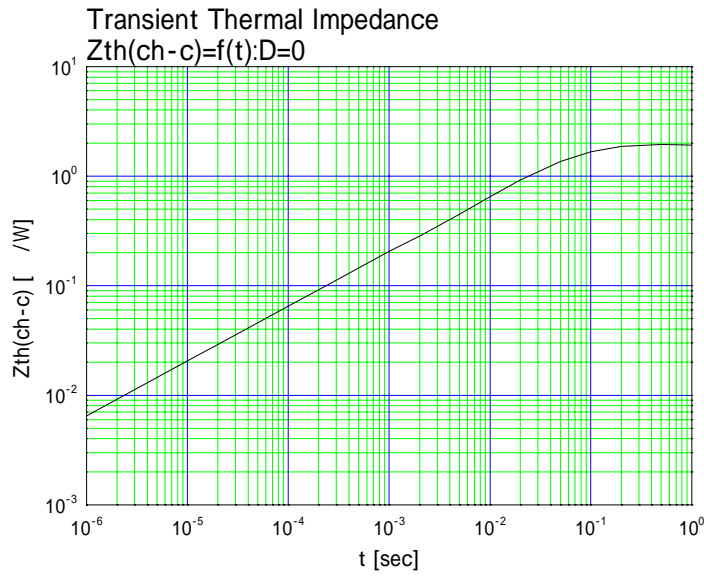

■ Outline Drawings (mm)

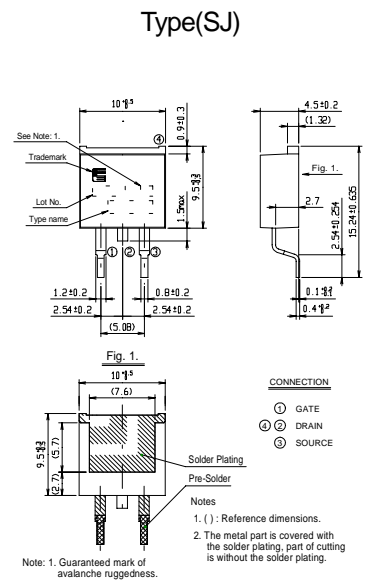
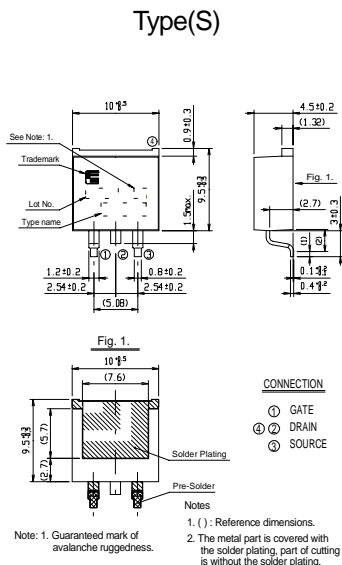
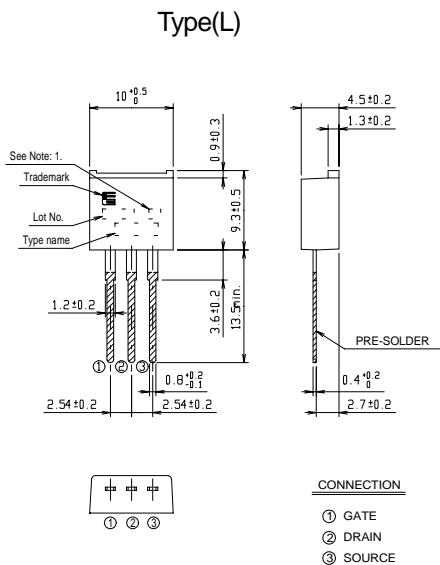

Note: 1. Guaranteed mark of avalanche ruggedness.