

Integrated Buffers with V_{COM}



The EL5524, EL5624, EL5724, and EL5824 integrate a number of gamma reference buffers with a single V_{COM} amplifier. The EL5524 contains 4 gamma buffers, the EL5624 contains 6, the EL5724 contains 8, and the EL5824 contains 10. Each gamma buffer has a bandwidth of 12MHz and features a slew rate of 15V/ μ s. The output current is rated at 30mA continuous, 140mA peak.

The V_{COM} amplifiers are rated for 60mA continuous output current and 200mA peak. They also feature higher slew rate and bandwidth for use in error cancellation circuits.

The EL5524 is available in the 14-pin HTSSOP package, the EL5624 in the 20-pin HTSSOP package, the EL5724 in the 24-pin HTSSOP package, and the EL5824 in the 28-pin HTSSOP package. All are specified for operation over the -40°C to +85°C temperature range.

Ordering Information

PART NUMBER	PACKAGE	TAPE & REEL	PKG. DWG. #
EL5524IRE	14-Pin HTSSOP	-	MDP0048
EL5524IRE-T7	14-Pin HTSSOP	7"	MDP0048
EL5524IRE-T13	14-Pin HTSSOP	13"	MDP0048
EL5624IRE	20-Pin HTSSOP	-	MDP0048
EL5624IRE-T7	20-Pin HTSSOP	7"	MDP0048
EL5624IRE-T13	20-Pin HTSSOP	13"	MDP0048
EL5724IRE	24-Pin HTSSOP	-	MDP0048
EL5724IRE-T7	24-Pin HTSSOP	7"	MDP0048
EL5724IRE-T13	24-Pin HTSSOP	13"	MDP0048
EL5824IRE	28-Pin HTSSOP	-	MDP0048
EL5824IRE-T7	28-Pin HTSSOP	7"	MDP0048
EL5824IRE-T13	28-Pin HTSSOP	13"	MDP0048

Features

- 4 x gamma buffers (EL5524)
- 6 x gamma buffers (EL5624)
- 8 x gamma buffers (EL5724)
- 10 x gamma buffers (EL5824)
- Single V_{COM} amplifier
- 140mA max V_{COM} output current
- Low power
 - 5.4mA (EL5524)
 - 6.8mA (EL5624)
 - 8.3mA (EL5724)
 - 9.5mA (EL5824)

Applications

- TFT-LCD displays
- Flat panel monitors
- Notebook displays
- LCD-TVs

Pinouts

EL5524
(14-PIN HTSSOP)
TOP VIEW

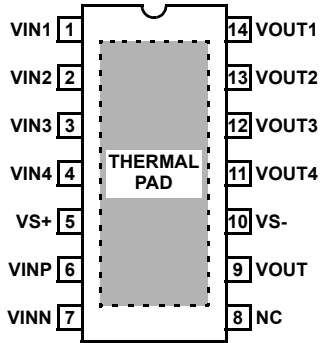

EL5624
(20-PIN HTSSOP)
TOP VIEW

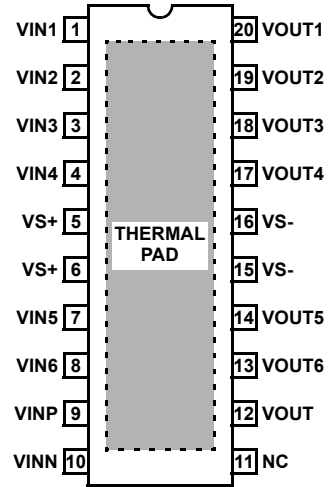

EL5724
(24-PIN HTSSOP)
TOP VIEW

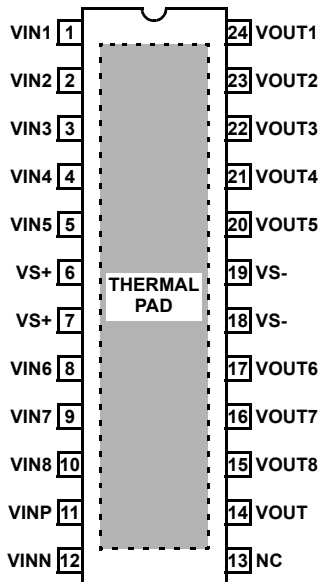

EL5824
(28-PIN HTSSOP)
TOP VIEW

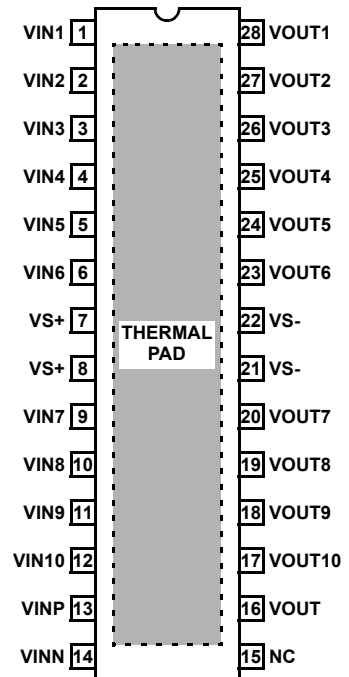

EL5524, EL5624, EL5724, EL5824

Absolute Maximum Ratings (T_A = 25°C)

Supply Voltage between V _{S+} and V _{S-} +18V	Power Dissipation See Curves
Input Voltage V _{S-} -0.5V, V _{S+} +0.5V	Maximum Die Temperature +125°C
Maximum Continuous Output Current (Buffer) 30mA	Storage Temperature -65°C to +150°C
Maximum Continuous Output Current (V _{COM}) 60mA	Operating Conditions -40°C to +85°C

CAUTION: Stresses above those listed in "Absolute Maximum Ratings" may cause permanent damage to the device. This is a stress only rating and operation of the device at these or any other conditions above those indicated in the operational sections of this specification is not implied.

NOTE: All parameters having Min/Max specifications are guaranteed. Typ values are for information purposes only. Unless otherwise noted, all tests are at the specified temperature and are pulsed tests, therefore: T_J = T_C = T_A

Electrical Specifications V_{S+} = +15V, V_{S-} = 0, R_L = 10kΩ, C_L = 10pF to 0V, Gain of V_{COM} = 1, R_LV_{COM} = 1kΩ and T_A = 25°C Unless Otherwise Specified

PARAMETER	DESCRIPTION	CONDITIONS	MIN	TYP	MAX	UNIT
INPUT CHARACTERISTICS (REFERENCE BUFFERS)						
V _{OS}	Input Offset Voltage	V _{CM} = 0V		2	14	mV
TCV _{OS}	Average Offset Voltage Drift	(Note 1)		5		μV/°C
I _B	Input Bias Current	V _{CM} = 0V		2	50	nA
R _{IN}	Input Impedance			1		GΩ
C _{IN}	Input Capacitance			1.35		pF
A _V	Voltage Gain	1V ≤ V _{OUT} ≤ 14V	0.992		1.008	V/V
INPUT CHARACTERISTICS (V_{COM} AMPLIFIER)						
V _{OS}	Input Offset Voltage	V _{CM} = 7.5V		1	15	mV
TCV _{OS}	Average Offset Voltage Drift	(Note 1)		5		μV/°C
I _B	Input Bias Current	V _{CM} = 7.5V		2	50	nA
R _{IN}	Input Impedance			1		GΩ
C _{IN}	Input Capacitance			1.35		pF
V _{REG}	Load Regulation	V _{COM} = 1.5V, -60mA < I _L < 60mA	-20		+20	mV
A _{VOL}	Open Loop Gain	R _L = 1kΩ	55	75		dB
CMRR	Common Rejection Ratio		45	70		dB
OUTPUT CHARACTERISTICS (REFERENCE BUFFERS)						
V _{OL}	Output Swing Low	I _L = 7.5mA		50	150	mV
V _{OH}	Output Swing High	I _L = 7.5mA	14.85	14.95		V
I _{SC}	Short Circuit Current	R _L = 10Ω	±120	±140		mA
OUTPUT CHARACTERISTICS (V_{COM} AMPLIFIER)						
V _{OL}	Output Swing Low	I _L = -7.5mA		50	150	mV
V _{OH}	Output Swing High	I _L = +7.5mA	14.85	14.95		V
I _{SC}	Short Circuit Current	R _L = 10Ω	±180	±200		mA
POWER SUPPLY PERFORMANCE						
PSRR	Power Supply Rejection Ratio	Reference buffer V _S from 4.5V to 15.5V	55	80		dB
		V _{COM} buffer, V _S from 4.5V to 15.5V	55	80		dB
I _S	Total Supply Current	EL5524 (no load)		5.4	7	mA
		EL5624 (no load)		6.8	8.5	mA
		EL5724 (no load)		8.3	11	mA
		EL5824 (no load)		9.5	12.5	mA

EL5524, EL5624, EL5724, EL5824

Electrical Specifications $V_{S+} = +15V$, $V_{S-} = 0$, $R_L = 10k\Omega$, $C_L = 10pF$ to $0V$, Gain of $V_{COM} = 1$, $RLV_{CM} = 1k\Omega$ and $T_A = 25^\circ C$ Unless Otherwise Specified **(Continued)**

PARAMETER	DESCRIPTION	CONDITIONS	MIN	TYP	MAX	UNIT
DYNAMIC PERFORMANCE (BUFFER AMPLIFIERS)						
SR	Slew Rate (Note 2)	$-4V \leq V_{OUT} \leq 4V$, 20% to 80%	7	15		V/ μ s
t_S	Settling to +0.1% ($A_V = +1$)	($A_V = +1$), $V_O = 2V$ step		250		ns
BW	-3dB Bandwidth	$R_L = 10k\Omega$, $C_L = 10pF$		12		MHz
GBWP	Gain-Bandwidth Product	$R_L = 10k\Omega$, $C_L = 10pF$		8		MHz
PM	Phase Margin	$R_L = 10k\Omega$, $C_L = 10pF$		50		$^\circ$
CS	Channel Separation	$f = 5MHz$		75		dB
DYNAMIC PERFORMANCE (V_{COM} AMPLIFIERS)						
SR	Slew Rate (Note 2)	$-4V \leq V_{OUT} \leq 4V$, 20% to 80%	65	90		V/ μ s
t_S	Settling to +0.1% ($A_V = +1$)	($A_V = +1$), $V_O = 6V$ step		150		ns
BW	-3dB Bandwidth	$R_L = 1k\Omega$, $C_L = 2pF$		35		MHz
GBWP	Gain-Bandwidth Product	$R_L = 1k\Omega$, $C_L = 2pF$		20		MHz
PM	Phase Margin	$R_L = 1k\Omega$, $C_L = 2pF$		50		$^\circ$

NOTES:

1. Measured over operating temperature range
2. Slew rate is measured on rising and falling edges

Pin Descriptions

EL5524	EL5624	EL5724	EL5824	PIN NAME	PIN FUNCTION
1	1	1	1	VIN1	Input
2	2	2	2	VIN2	Input
3	3	3	3	VIN3	Input
4	4	4	4	VIN4	Input
5	5, 6	6, 7	7, 8	VS+	Positive supply
6	9	11	13	VINP	Positive input - V_{COM}
7	10	12	14	VINN	Negative input - V_{COM}
8	11	13	15	NC	Not connected
9	12	14	16	VOUT	Output for V_{COM}
10	15, 16	18, 19	21, 22	VS-	Negative supply
11	17	21	25	VOUT4	Output
12	18	22	26	VOUT3	Output
13	19	23	27	VOUT2	Output
14	20	24	28	VOUT1	Output
	7	5	5	VIN5	Input
	8	8	6	VIN6	Input
	14	20	24	VOUT5	Output
	13	17	23	VOUT6	Output
		9	9	VIN7	Input
		10	10	VIN8	Input
		16	20	VOUT7	Output
		15	19	VOUT8	Output
			11	VIN9	Input
			12	VIN10	Input
			18	VOUT9	Output
			17	VONT10	Output

Test Circuits

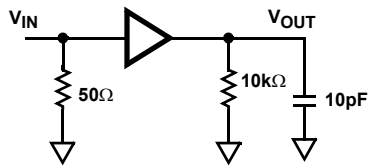

FOR BUFFERS

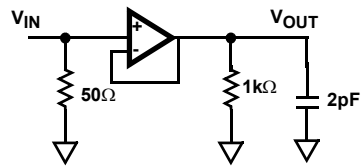

FOR V_{COM}

Typical Performance Curves

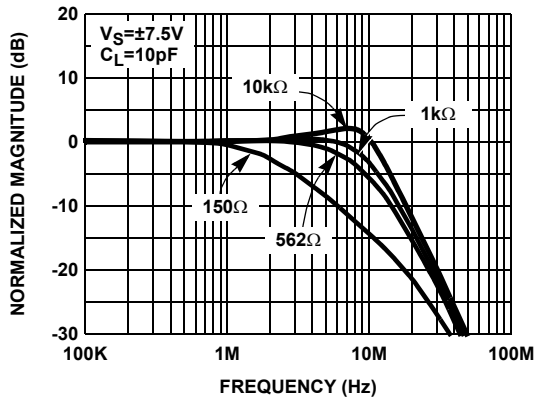

FIGURE 1. FREQUENCY RESPONSE FOR VARIOUS R_L (BUFFER)

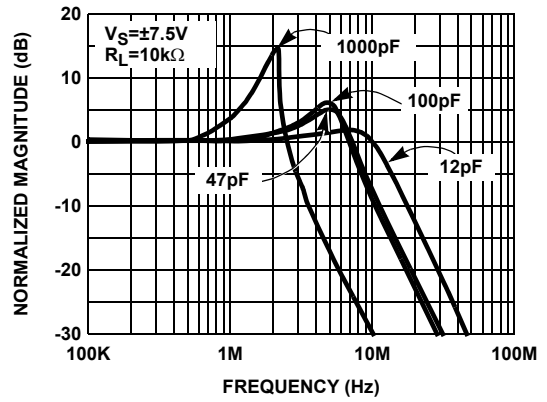

FIGURE 2. FREQUENCY RESPONSE FOR VARIOUS C_L (BUFFER)

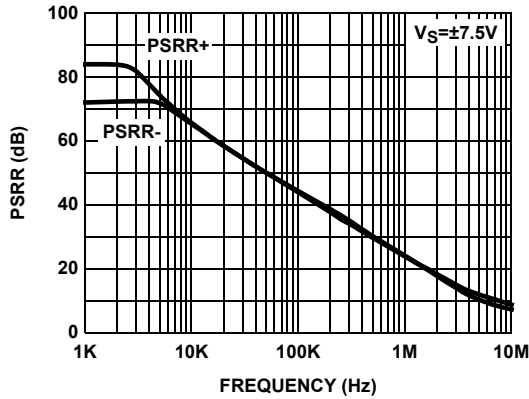

FIGURE 3. PSRR vs FREQUENCY (BUFFER)

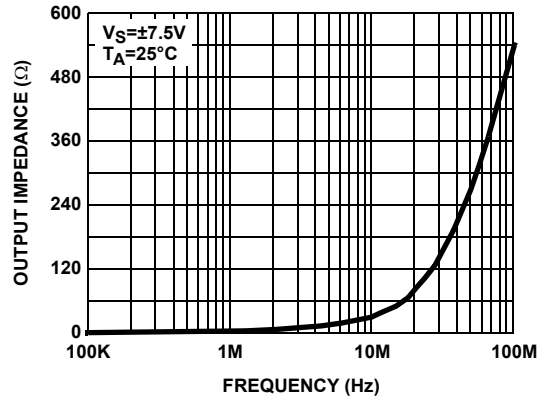

FIGURE 4. OUTPUT IMPEDANCE vs FREQUENCY (BUFFER)

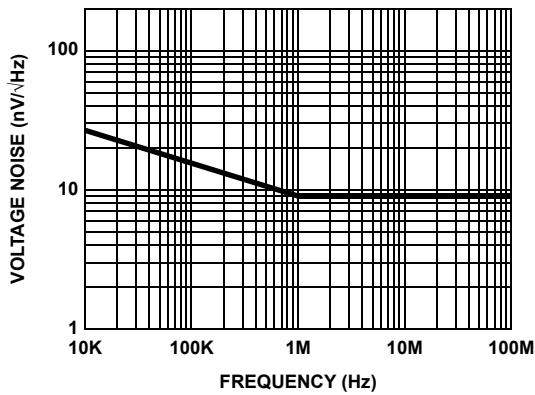

FIGURE 5. INPUT NOISE SPECIAL DENSITY vs FREQUENCY (BUFFER)

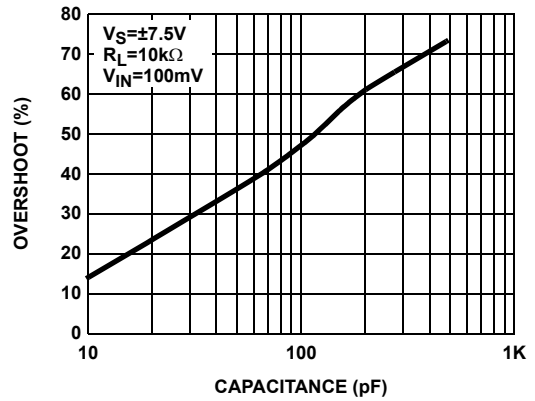

FIGURE 6. OVERSHOOT vs LOAD CAPACITANCE (BUFFER)

Typical Performance Curves (Continued)

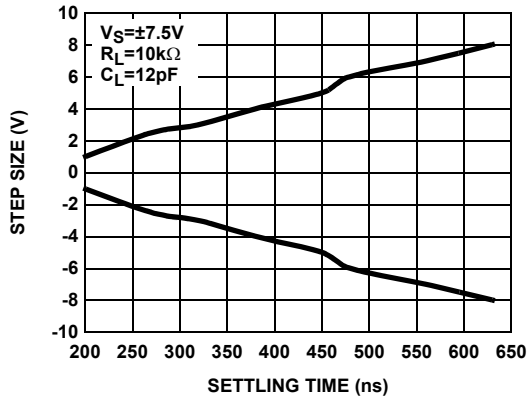

FIGURE 7. SETTLING TIME vs STEP SIZE (BUFFER)

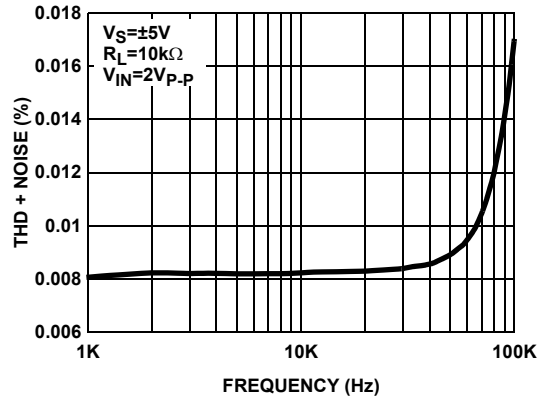

FIGURE 8. TOTAL HARMONIC DISTORTION + NOISE vs FREQUENCY (BUFFER)

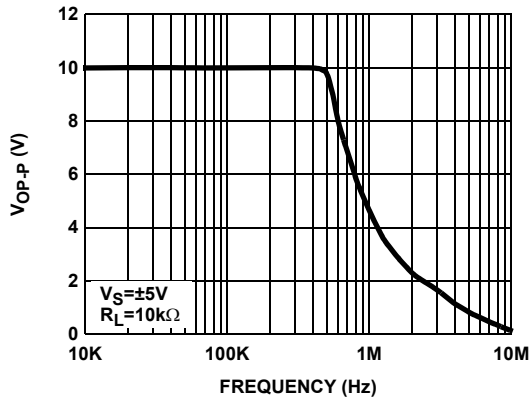

FIGURE 9. OUTPUT SWING vs FREQUENCY (BUFFER)

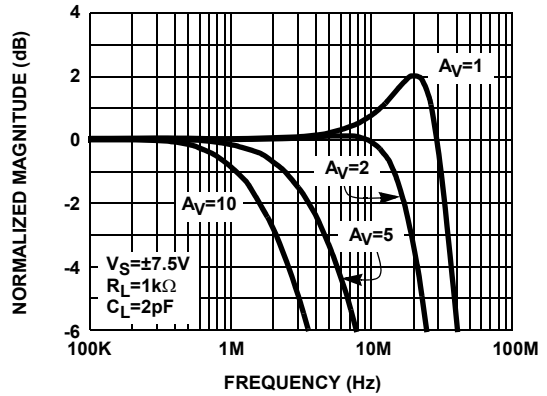

FIGURE 10. FREQUENCY RESPONSE (V_{COM})

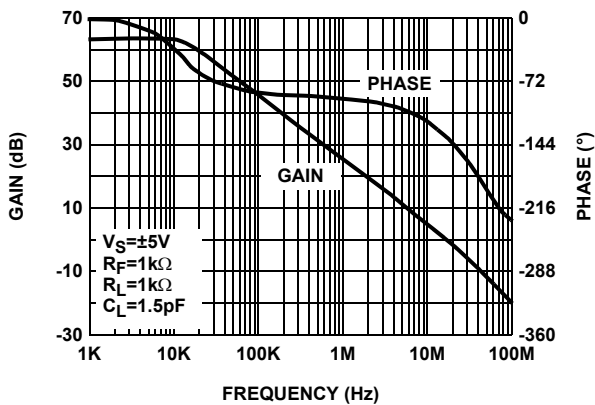

FIGURE 11. OPEN LOOP GAIN AND PHASE vs FREQUENCY

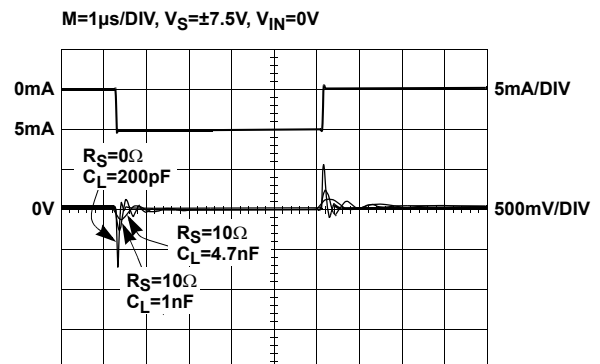

FIGURE 12. TRANSIENT LOAD REGULATION - SOURCING (BUFFER)

Typical Performance Curves (Continued)

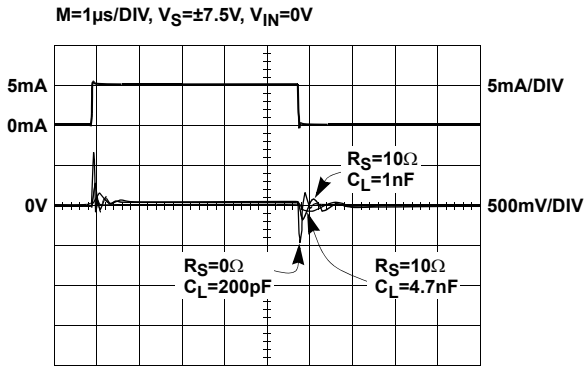

FIGURE 13. TRANSIENT LOAD REGULATION - SINKING (BUFFER)

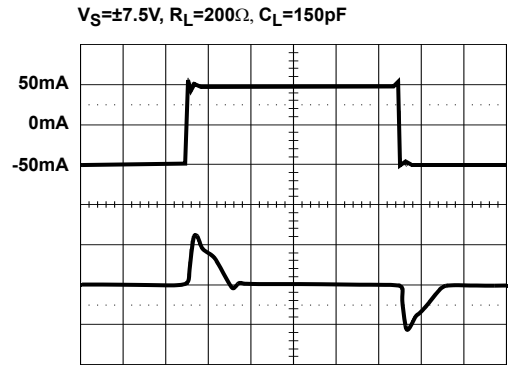

FIGURE 14. TRANSIENT LOAD REGULATION (V_{COM})

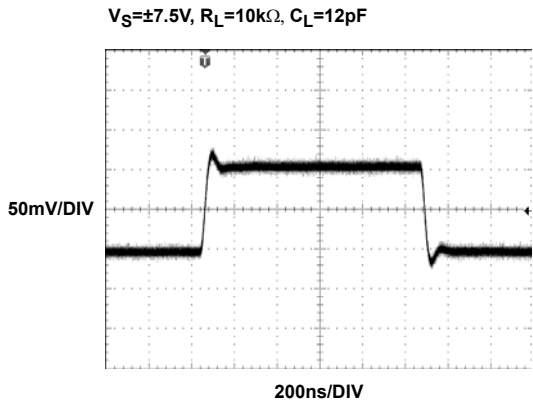

FIGURE 15. SMALL SIGNAL TRANSIENT RESPONSE (BUFFER)

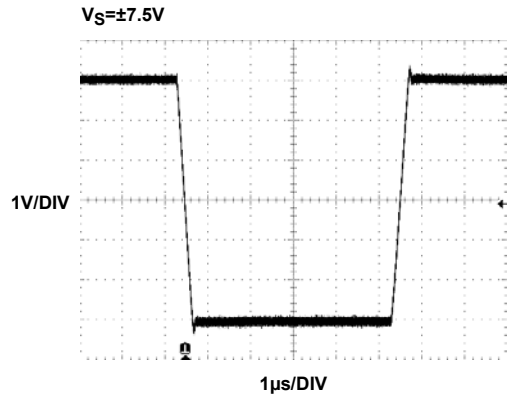

FIGURE 16. LARGE SIGNAL TRANSIENT RESPONSE (BUFFER)

1

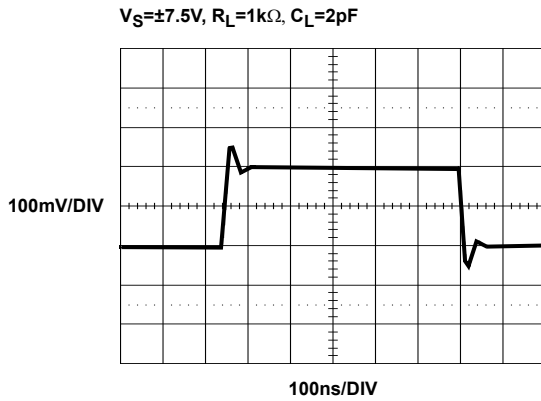

FIGURE 17. SMALL SIGNAL TRANSIENT RESPONSE (V_{COM})

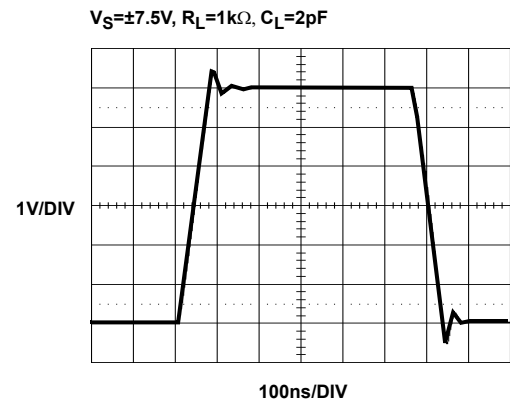

FIGURE 18. LARGE SIGNAL TRANSIENT REPNSE (V_{COM})

Typical Performance Curves (Continued)

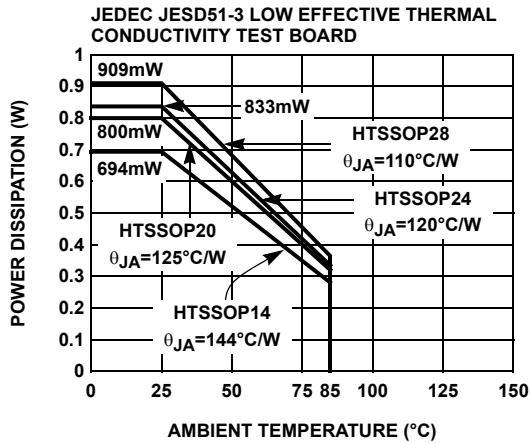

FIGURE 19. PACKAGE POWER DISSIPATION vs AMBIENT TEMPERATURE

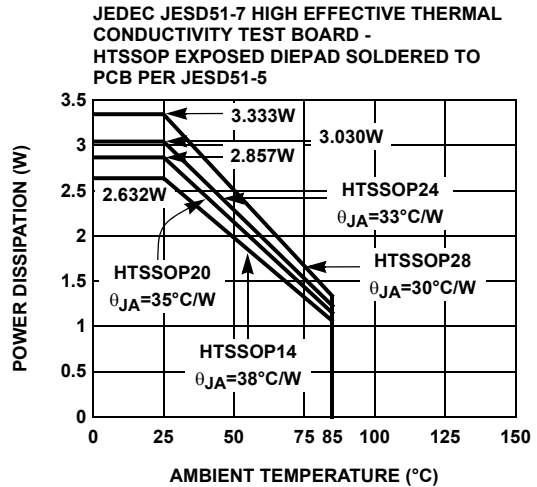

FIGURE 20. PACKAGE POWER DISSIPATION vs AMBIENT TEMPERATURE

Description of Operation and Application Information

Product Description

The EL5524, EL5624, EL5724, and EL5824 are fabricated using a high voltage CMOS process. They exhibit rail to rail input and output capability and have very low power consumption. When driving a load of 10K and 12pF, the buffers have a -3dB bandwidth of 12MHz and exhibit 18V/μs slew rate. The V_{COM} amplifier has a -3dB bandwidth of 35MHz and exhibit 80V/μs slew rate.

Input, Output, and Supply Voltage Range

The EL5524, EL5624, EL5724, and EL5824 are specified with a single nominal supply voltage from 5V to 15V or a split supply with its total range from 5V to 15V. Correct operation is guaranteed for a supply range from 4.5V to 16.5V.

The input common-mode voltage range of the EL5524, EL5624, EL5724, and EL5824 extends 500mV beyond the supply rails. The output swings of the buffers and V_{COM} amplifier typically extend to within 100mV of the positive and negative supply rails with load currents of 5mA. Decreasing load currents will extend the output voltage even closer to each supply rails.

Output Phase Reversal

The EL5524, EL5624, EL5724, and EL5824 are immune to phase reversal as long as the input voltage is limited from V_{S-} -0.5V to V_{S+} +0.5V. Although the device's output will not change phase, the input's overvoltage should be avoided. If an input voltage exceeds supply voltage by more than 0.6V, electrostatic protection diode placed in the input stage of the device begin to conduct and overvoltage damage could occur.

Choice of Feedback Resistor and Gain Bandwidth Product for V_{COM} Amplifier

For applications that require a gain of +1, no feedback resistor is required. Just short the output pin to the inverting input pin. For gains greater than +1, the feedback resistor forms a pole with the parasitic capacitance at the inverting input. As this pole becomes smaller, the amplifier's phase margin is reduced. This causes ringing in the time domain and peaking in the frequency domain. Therefore, R_F has some maximum value that should not be exceeded for optimum performance. If a large value of R_F must be used, a small capacitor in the few Pico farad range in parallel with R_F can help to reduce the ringing and peaking at the expense of reducing the bandwidth.

As far as the output stage of the amplifier is concerned, the output stage is also a gain stage with the load. R_F and R_G appear in parallel with R_L for gains other than +1. As this combination gets smaller, the bandwidth falls off. Consequently, R_F also has a minimum value that should not be exceeded for optimum performance. For gain of +1, R_F = 0 is optimum. For the gains other than +1, optimum response is obtained with R_F between 1kΩ to 5kΩ.

The V_{COM} amplifier has a gain bandwidth product of 20MHz. For gains ≥5, its bandwidth can be predicted by the following equation:

$$\text{Gain} \times \text{BW} = 20\text{MHz}$$

Output Drive Capability

The EL5524, EL5624, EL5724, and EL5824 do not have internal short-circuit protection circuitry. The buffers will limit the short circuit current to ±120mA and the V_{COM} amplifier

will limit the short circuit current to $\pm 200\text{mA}$ if the outputs are directly shorted to the positive or the negative supply. If the output is shorted indefinitely, the power dissipation could easily increase such that the part will be destroyed.

Maximum reliability is maintained if the output continuous current never exceeds $\pm 30\text{mA}$ for the buffers and $\pm 60\text{mA}$ for the V_{COM} amplifier. These limits are set by the design of the internal metal interconnections.

The Unused Buffers

It is recommended that any unused buffers should have their inputs tied to ground plane.

Power Dissipation

With the high-output drive capability of the EL5524, EL5624, EL5724, and EL5824, it is possible to exceed the 125°C "absolute-maximum junction temperature" under certain load current conditions. Therefore, it is important to calculate the maximum junction temperature for the application to determine if load conditions need to be modified for the buffer to remain in the safe operating area.

The maximum power dissipation allowed in a package is determined according to:

$$P_{\text{DMAX}} = \frac{T_{\text{JMAX}} - T_{\text{AMAX}}}{\theta_{\text{JA}}}$$

where:

- T_{JMAX} = Maximum junction temperature
- T_{AMAX} = Maximum ambient temperature
- θ_{JA} = Thermal resistance of the package
- P_{DMAX} = Maximum power dissipation in the package

The maximum power dissipation actually produced by an IC is the total quiescent supply current times the total power supply voltage, plus the power in the IC due to the loads, or:

$$P_{\text{DMAX}} = V_{\text{S}} \times I_{\text{S}} + \sum i \times [(V_{\text{S}^+} - V_{\text{OUT}^i}) \times I_{\text{LOAD}^i}] + (V_{\text{S}^+} - V_{\text{OUT}}) \times I_{\text{LA}}$$

when sourcing, and:

$$P_{\text{DMAX}} = V_{\text{S}} \times I_{\text{S}} + \sum i \times [(V_{\text{OUT}^i} - V_{\text{S}^-}) \times I_{\text{LOAD}^i}] + (V_{\text{OUT}} - V_{\text{S}^-}) \times I_{\text{LA}}$$

when sinking.

where:

- $i = 1$ to total number of buffers
- V_{S} = Total supply voltage of buffer and V_{COM}
- I_{SMAX} = Total quiescent current
- V_{OUT^i} = Maximum output voltage of the application
- V_{OUT} = Maximum output voltage of V_{COM}
- I_{LOAD^i} = Load current of buffer
- I_{LA} = Load current of V_{COM}

If we set the two P_{DMAX} equations equal to each other, we can solve for the R_{LOAD} 's to avoid device overheat. The package power dissipation curves provide a convenient way to see if the device will overheat. The maximum safe power dissipation can be found graphically, based on the package type and the ambient temperature. By using the previous equation, it is a simple matter to see if P_{DMAX} exceeds the device's power derating curves.

Power Supply Bypassing and Printed Circuit Board Layout

As with any high frequency device, good printed circuit board layout is necessary for optimum performance. Ground plane construction is highly recommended, lead lengths should be as short as possible, and the power supply pins must be well bypassed to reduce the risk of oscillation. For normal single supply operation, where the V_{S^-} pin is connected to ground, one $0.1\mu\text{F}$ ceramic capacitor should be placed from the V_{S^+} pin to ground. A $4.7\mu\text{F}$ tantalum capacitor should then be connected from the V_{S^+} pin to ground. One $4.7\mu\text{F}$ capacitor may be used for multiple devices. This same capacitor combination should be placed at each supply pin to ground if split supplies are to be used.

Important Note: The metal plane used for heat sinking of the device is electrically connected to the negative supply potential (V_{S^-}). If V_{S^-} is tied to ground, the thermal pad can be connected to ground. Otherwise, the thermal pad must be isolated from any other power planes.

Package Outline Drawing

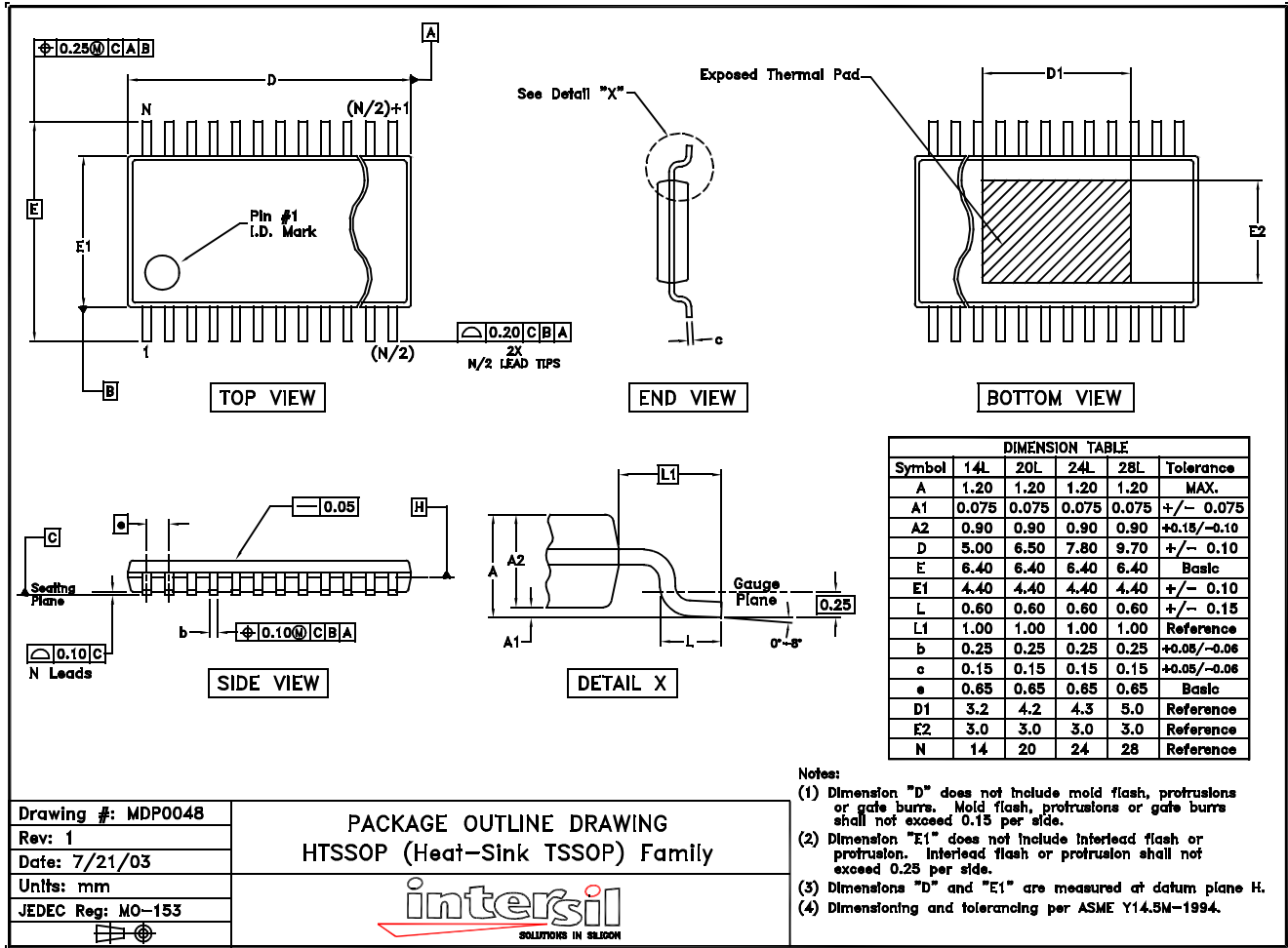

NOTE: The package drawings shown here may not be the latest versions. For the latest revisions, please refer to the Intersil website at www.intersil.com/design/packages/elantec

All Intersil U.S. products are manufactured, assembled and tested utilizing ISO9000 quality systems. Intersil Corporation's quality certifications can be viewed at www.intersil.com/design/quality

Intersil products are sold by description only. Intersil Corporation reserves the right to make changes in circuit design, software and/or specifications at any time without notice. Accordingly, the reader is cautioned to verify that data sheets are current before placing orders. Information furnished by Intersil is believed to be accurate and reliable. However, no responsibility is assumed by Intersil or its subsidiaries for its use; nor for any infringements of patents or other rights of third parties which may result from its use. No license is granted by implication or otherwise under any patent or patent rights of Intersil or its subsidiaries.

For information regarding Intersil Corporation and its products, see www.intersil.com