

# HMS88T1932

## *New 80C52 Based High Security Smart Card IC*

### ***General Features***

- TurboCore : High Security 8-bit 80C52 compatible CPU
  - ✓ Multiple source vectorized interrupt system with two priority levels
  - ✓ Multiple source reset system
  
- High reliable EEPROM for data storage
  - ✓ 32KB high reliability EEPROM
  - ✓ 1 to 64 bytes per a page
  - ✓ 64 bytes security area (OTP : One Time Programmable)
  - ✓ Byte-wise EEPROM programming and read access
  - ✓ EEPROM endurance: 300,000 cycles at 25°C
  - ✓ EEPROM data retention: min. 10 years
  - ✓ EEPROM management library (EML) with intelligent write algorithm
  
- 1MHz to 6MHz operating clock frequency range for program execution from ROM
  
- Integrated On-Chip Memory
  - ✓ 192KB User ROM : non-visible & scramble ROM code
  - ✓ 256B IRAM
  - ✓ 6KB XRAM
  
- Integrated Peripherals
  - ✓ Interrupt module for I/O interface and peripherals
  - ✓ UART supporting ISO standard protocols T = 0 and T = 1
  - ✓ True random number generator in hardware
  - ✓ CRC module : 16 bit checksum according to ISO3309
  
- 2.7V to 5.5V extended operating voltage range
- Power saving IDLE mode
- Low power SLEEP mode
- Pad configuration according to ISO/IEC 7816: VDD, VSS, CLK, RST and I/O1
- Serial interface according to ISO/IEC 7816-3
- Meets GSM 11.11 and 11.12 Specifications

## Security Features

- Data encryption according to T-DES standard
- ROM code not visible due to implantation
- Low/High supply voltage detector
- Low/High clock frequency detector
- Metal shield detector
- Internal power-on-reset
- Unique chip identification number for each chip
- Memory data / address encryption & scrambling
- Memory segmentation
- Random waitstate generator

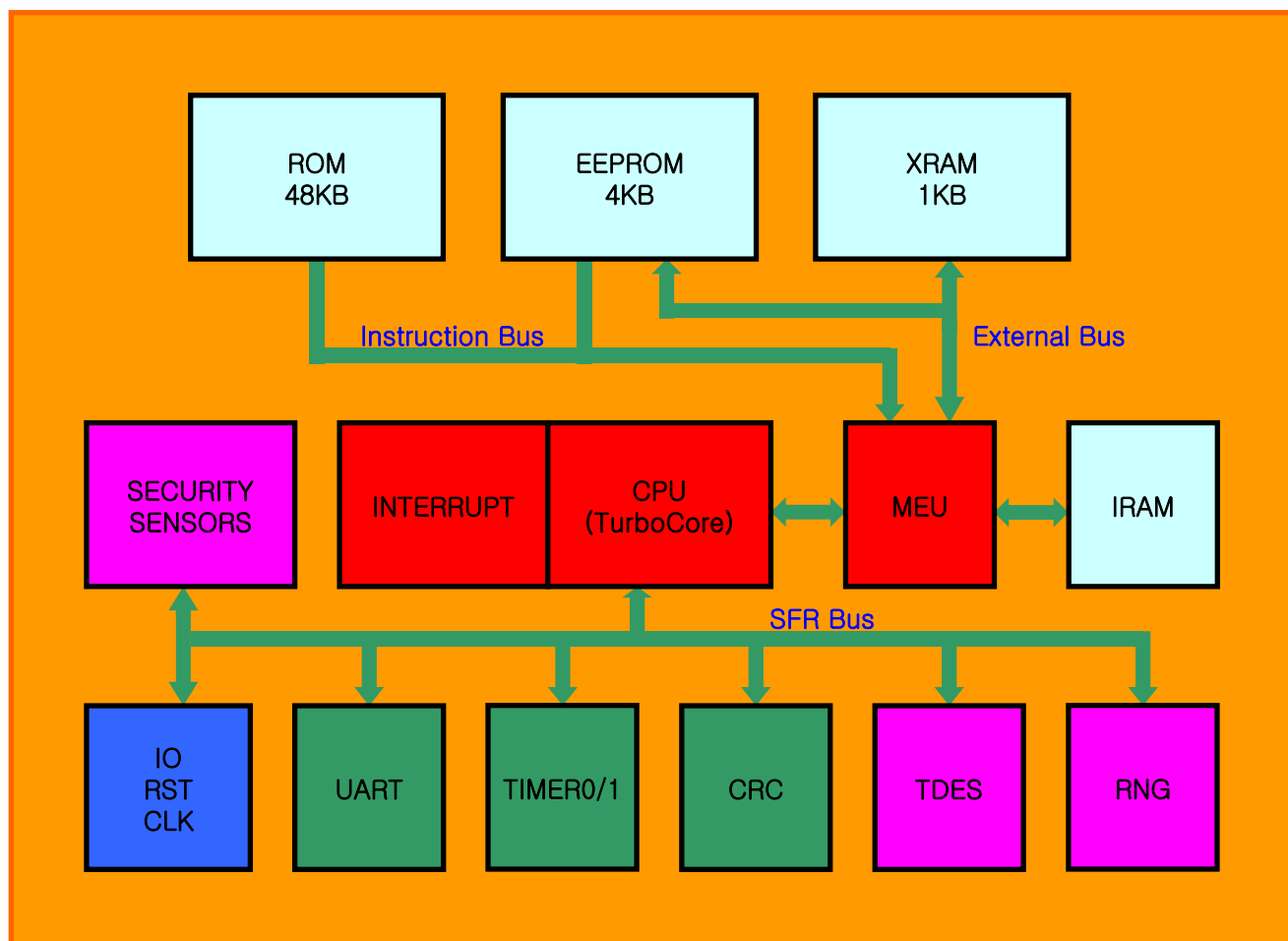

Block Diagram