

SK-A2910 Series



Size, mm

20 x 13

I/O

8 pin (14 pin) SMD Gull Wing

Supply Voltage

3.3V / 5V

Differential Positive ECL (DPECL)

SK-A2910 Series *Rev H*

Frequency Range: 100.0 MHz to 320.0 MHz

Description

The SK-A2910 Series of quartz crystal oscillators provide DPECL Fast Edge compatible signals. This device is to operate using positive voltage and uses multiple ground pins for improved signal integrity. This device is intended to operate on positive voltage for PECL applications.

Features

- High Reliability - NEL HALT/HASS qualified for crystal oscillator start-up conditions
- Low jitter - Wavecrest jitter characterization available
- Wide frequency range—100.0 MHz to 320.0 MHz
- User specified tolerance available
- Case at electrical ground
- Will withstand vapor phase temperatures of 253°C for 4 minutes maximum
- All metal, resistance weld, hermetically sealed package
- High shock resistance, to 1500g
- Overtone technology
- High Q crystal actively tuned oscillator circuit
- Power supply decoupling internal
- Dual ground plane for added stability
- No internal PLL avoids cascading PLL problems
- High frequencies due to proprietary design
- RoHS Compliant, Lead Free Construction

Creating a Part Number

SK - A291X - FREQ

Package Code

HK Leaded 8 pin (14 pin)
SK 8 pin (14 pin) SMD Gull Wing

Input Voltage

Code Specification
A 3.3 V
5 5 V

Tolerance/Performance

0 ±100 ppm 0-70°C
1 ±50 ppm 0-70°C
7 ±25 ppm 0-70°C
9 Customer Specific
A ±20 ppm 0-70°C
B ±50 ppm -40 to +85°C
C ±100 ppm -40 to +85°C

Drawing Specifications

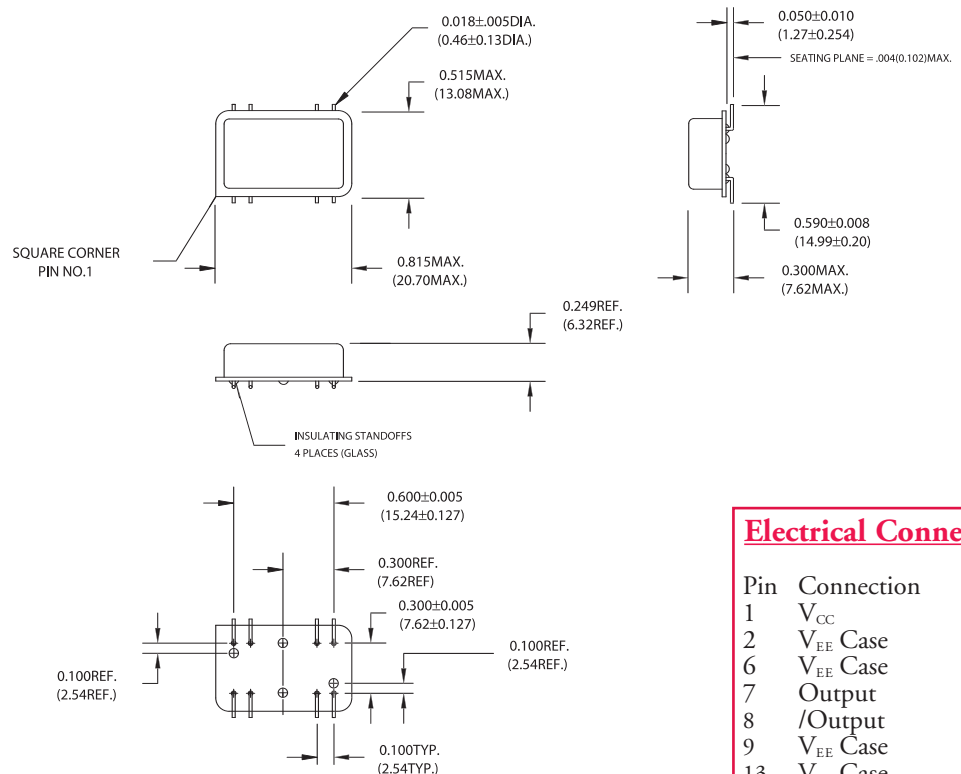

Electrical Connection

Pin	Connection
1	V _{CC}
2	V _{EE} Case
6	V _{EE} Case
7	Output
8	/Output
9	V _{EE} Case
13	V _{EE} Case
14	Enable/Disable

Dimensions shown in inches and millimeters.



For the most up to date specifications on each NEL product, log on to our website—
www.nelfc.com

Differential Positive ECL (DPECL)

SK-A2910 Series *Rev H*

Frequency Range: 100.0 MHz to 320.0 MHz

Operating Conditions and Output Characteristics

Electrical Characteristics

Parameter	Symbol	Conditions	Min	Typical	Max
Frequency	—	—	100.0 MHz	—	320.0 MHz
Duty Cycle	—	@50% points	45/55%	—	55/45%
Logic 0 ⁽²⁾	V _{OL}	—	V _{CC} -1.810 V	—	V _{CC} -1.620 V
Logic 1 ⁽²⁾	V _{OH}	—	V _{CC} -1.025 V	—	V _{CC} -0.88 V
Rise & Fall Time	t _r , t _f	20-80% V _O , with 50 ohm load to V _{CC} -2V	—	350 psec	600 psec
Jitter, RMS ⁽³⁾	—	—	—	—	3 psec
Enable Voltage ⁽⁴⁾	—	with V _{EE} = 0V	0 V	—	1.0 V
Disable Voltage	—	with V _{EE} = 0V	3.0 V	—	V _{CC}
Frequency Stability ⁽¹⁾	dF/F	Overall conditions including: voltage, calibration, temp., 10 yr aging, shock, vibration	-100 ppm	—	+100 ppm

General Characteristics

Parameter	Symbol	Conditions	Min	Typical	Max
Supply Voltage	V _{CC}	—	3.135 V	3.3 V	3.465 V
Supply Current	I _{CC}	50 ohm termination to 2.00 V below V _{CC}	0.0 mA	—	120 mA
Output Current	I _O	Low level Output Current	0.0 mA	—	±50.0 mA
Operating Temperature	T _A	—	0°C	—	70°C
Storage Temperature	T _S	—	-55°C	—	125°C
Input: Logic High (ECL) - Disables V _{EE} or Open - Enables	—	—	—	—	—
Lead Temperature	T _L	Soldering, 10 sec.	—	—	300°C
Load	—	50 ohm to V _{CC} -2V or Thevenin Equivalent, Bias Required	—	—	—
Start-up Time	t _s	—	—	2 ms	10 ms

Environmental and Mechanical Characteristics

Mechanical Shock	Per MIL-STD-202, Method 213, Condition E
Thermal Shock	Per MIL-STD-833, Method 1011, Condition A
Vibration	0.060" double amplitude 10 Hz to 55 Hz, 35g's 55 Hz to 2000 Hz
Soldering Condition	300°C for 10 seconds
Hermetic Seal	Leak rate less than 1 x 10 ⁻⁸ atm.cc/sec of helium

Footnotes:

- 1) Standard frequency stability (±20, ±25, ±50 ppm & others available).
- 2) V_{OL}, V_{OH}, referenced to ground.
- 3) Jitter performance is frequency dependent. Please contact factory for full Wavecrest characterization. RMS jitter bandwidth of 12kHz to 20MHz.
- 4) Open to Enable pin also enables the output.

Test Circuit

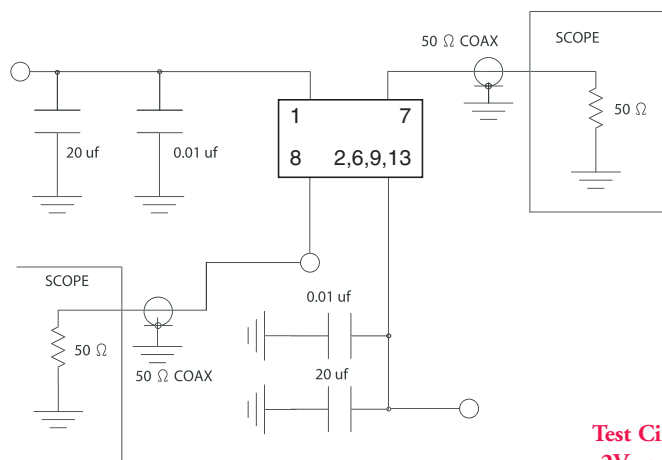

Test Circuit uses a split supply of +2V and -1.3V for ease of testing.