

HBT DUAL DRIVER AMPLIFIER DC - 3.0 GHz

FEBRUARY 2001

v00.1200

Features

P1dB Output Power: + 16 dBm

Output IP3: +31 dBm

Single Supply: 8.75V

Ultra Small Package: MSOP8G



General Description

The HMC324MS8G is a high efficiency GaAs InGaP Heterojunction Bipolar Transistor (HBT) MMIC amplifier that contains two un-connected amplifiers in parallel inside an 8 lead MSOPG package. When used in conjunction with an external balun, the outputs of the amplifier can be combined to reduce the 2nd harmonic distortion that is generated by the amplifier. With V_{cc} at +7.5V, the HMC324MS8G offers 13 dB of gain and with power combining and harmonic cancellation, +22 dBm of output power can be achieved. Using a Darlington feedback pair results in reduced sensitivity to normal process variations and provides a good 50-ohm input/output port match. This amplifier is ideal for RF systems where high linearity is required. The design can operate in 50-ohm and 75-ohm systems which makes it ideal for CATV head-end and modem, and MCNS applications.

Guaranteed Performance, -40 to +60 deg C

Parameter	Vs= 8.75V, RBIAS= 22 Ohm			Units
	Min.	Typ.	Max.	
Frequency Range	DC - 3.0			GHz
Gain @ 25 °C	10	13	16	dB
Gain Variation over Temperature		0.015	0.025	dB/ °C
Input Return Loss	8	13		dB
Output Return Loss	6	9		dB
Reverse Isolation	16	20		dB
Output Power for 1dB Compression (P1dB) @ 1 GHz	13	16		dBm
Saturated Output Power (Psat) @ 1 GHz	16	19		dBm
Output Third Order Intercept (IP3) @ 1 GHz	28	31		dBm
Noise Figure		6		dB
Supply Current (Icc)		57		mA

Note: All specifications refer to a single amplifier.



HBT DUAL DRIVER AMPLIFIER DC - 3.0 GHz

v00.1200

FEBRUARY 2001

Gain & Return Loss

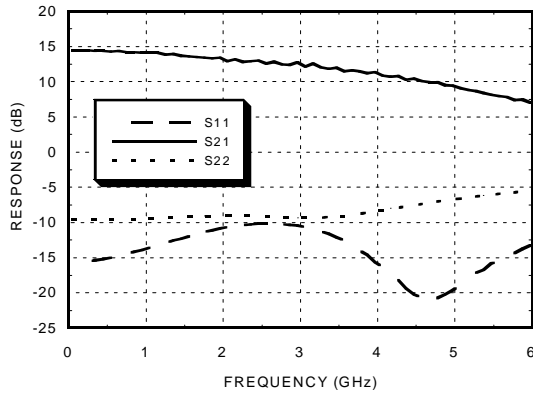

Gain vs. Temperature

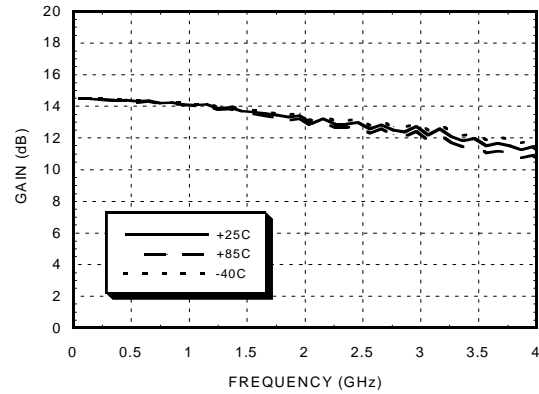

Input Return Loss vs. Temperature

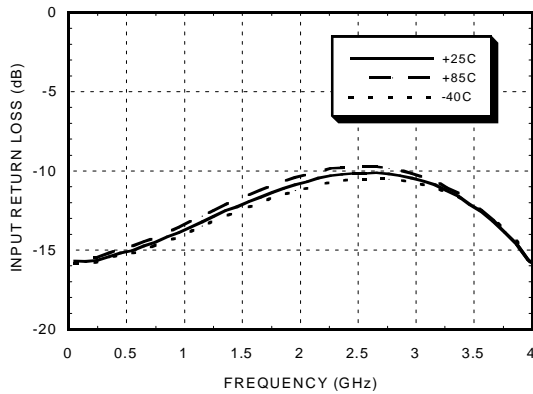

Output Return Loss vs. Temperature

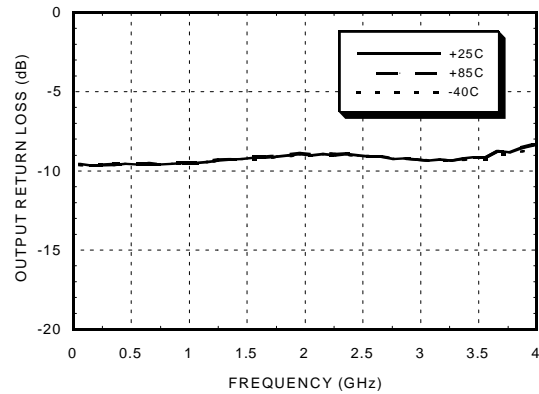

Reverse Isolation vs. Temperature

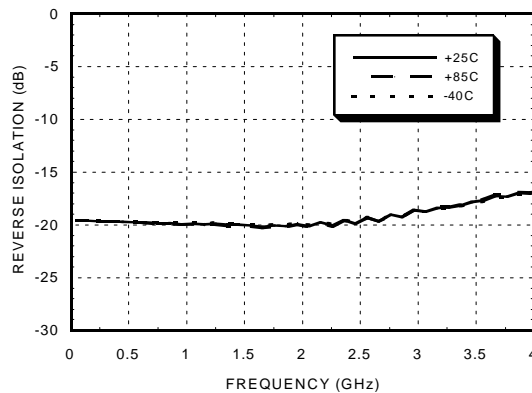

1
AMPLIFIERS
SMT



HBT DUAL DRIVER AMPLIFIER DC - 3.0 GHz

FEBRUARY 2001

v00.1200

1
AMPLIFIERS
SMT

P1dB vs. Temperature

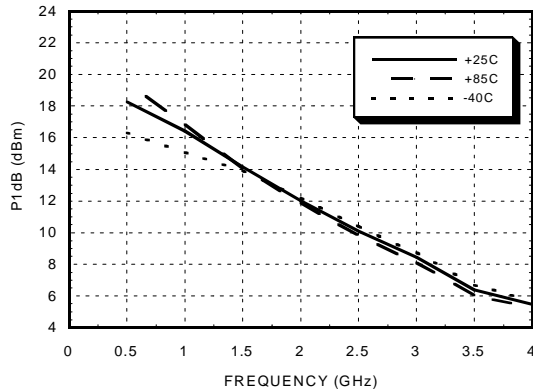

Psat vs. Temperature

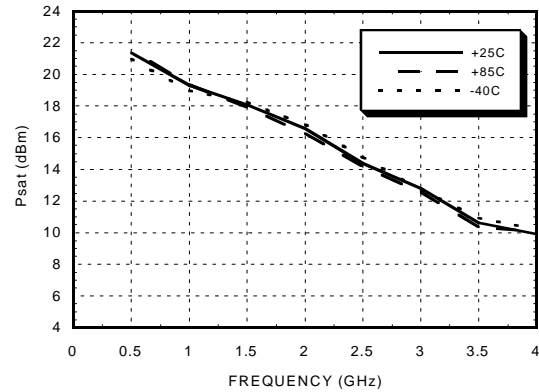

Power Compression @ 1 GHz

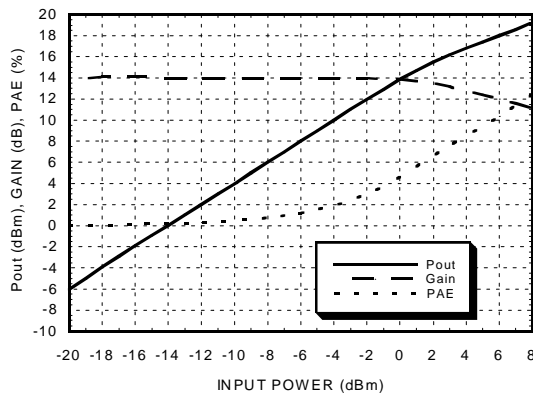

Power Compression @ 2 GHz

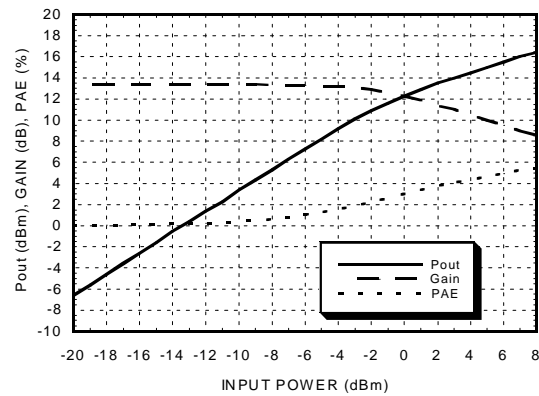

Output IP3 vs. Temperature

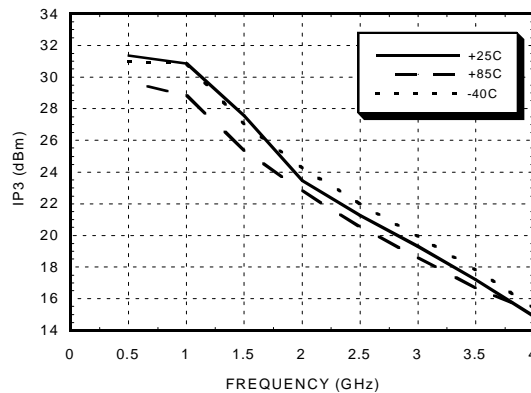

HBT DUAL DRIVER AMPLIFIER DC - 3.0 GHz

v00.1200

FEBRUARY 2001

Schematic

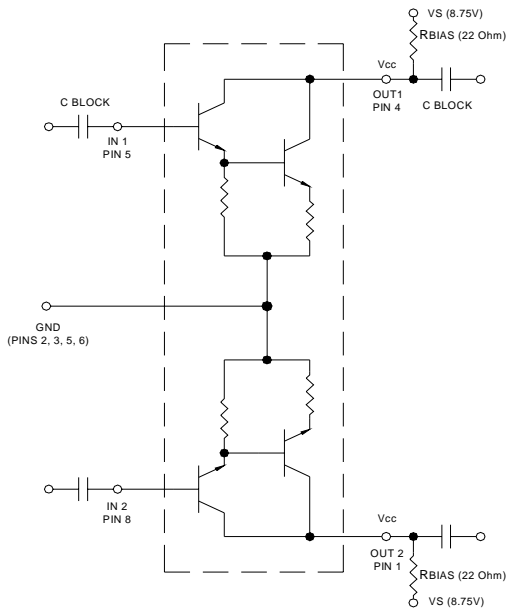

Absolute Maximum Ratings

DC Voltage on Pin 1	8 Volts
Input Power (RF _{in})(V _{cc} = +5V)	+20 dBm
Channel Temperature (T _c)	175 °C
Continuous P _{diss} (T _a = 60 °C) (derate 4.41 mW/ °C above 60 °C)	507 mW
Storage Temperature	-65 to +150 °C
Operating Temperature	-55 to +60 °C

Note:

1. Select R_{BIAS} to achieve desired V_{cc} voltage on Pin 1.
2. External blocking capacitors are required on Pins 1, 4, 5, and 8.

Outline

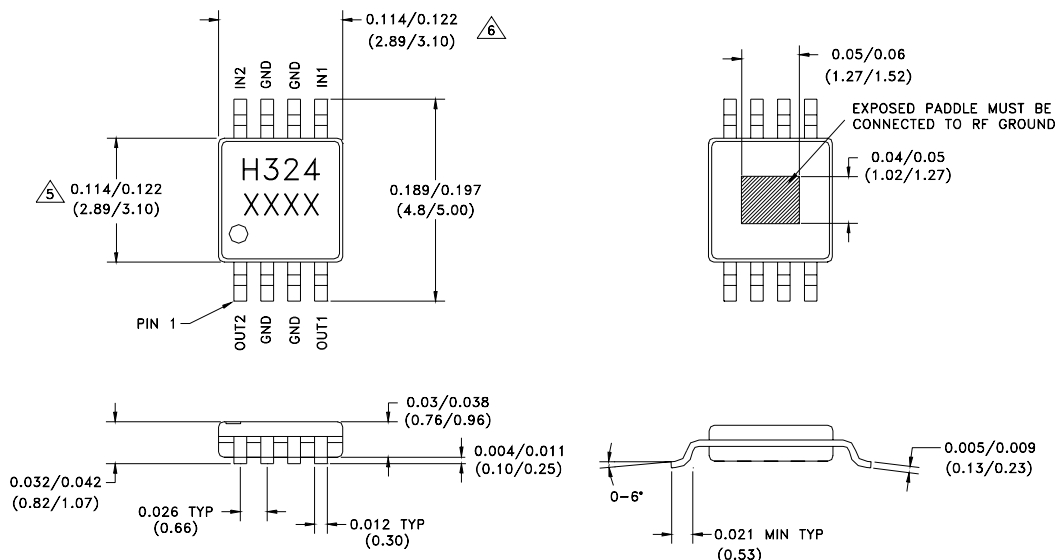

1. MATERIAL:
A) PACKAGE BODY - LOW STRESS INJECTION-MOLDED PLASTIC, SILICA & SILICONE IMPREGNATED.
B) LEADFRAME MATERIAL: COPPER ALLOY
2. PLATING: LEAD - TIN SOLDER PLATE
3. DIMENSIONS ARE IN INCHES (MILLIMETERS).

4. UNLESS OTHERWISE SPECIFIED ALL TOL. ARE ±0.005 (±0.13).
CHARACTERS TO BE HELVETICA MEDIUM, APPROX .020 HIGH WHITE INK, LOCATED APPROXIMATELY AS SHOWN.
DIMENSION DOES NOT INCLUDE MOLDFLASH OF 0.15 MM PER SIDE
DIMENSION DOES NOT INCLUDE MOLDFLASH OF 0.25 MM PER SIDE

1
AMPLIFIERS
SMT

HBT DUAL DRIVER AMPLIFIER DC - 3.0 GHz

FEBRUARY 2001

v00.1200

Evaluation PCB for HMC324MS8G

1
AMPLIFIERS
SMT

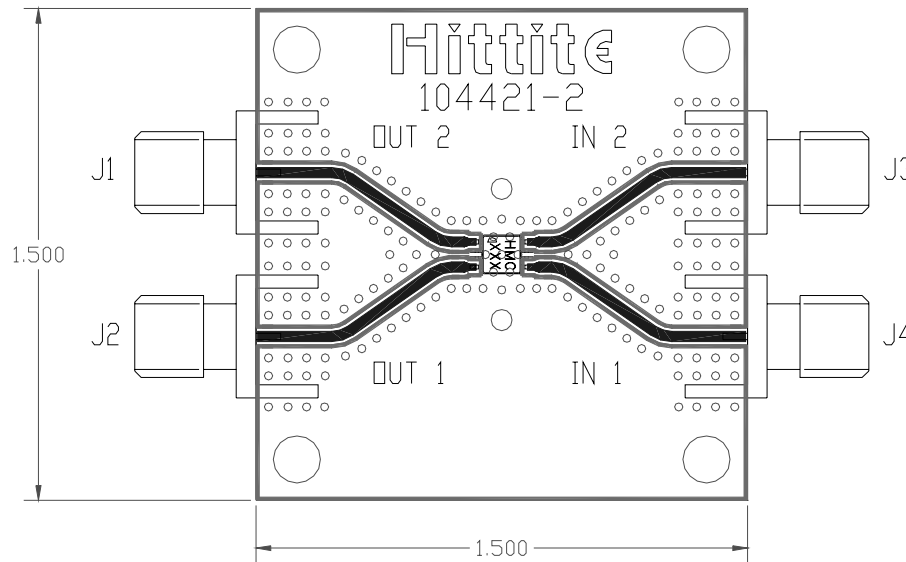
The circuit board used in the final application should use RF circuit design techniques. Signal lines should have 50 ohm impedance while the package ground leads and exposed paddle should be connected directly to the ground plane similar to that shown above. A sufficient number of VIA holes should be used to connect the top and bottom ground planes. The evaluation circuit board as shown is available from Hittite upon request.

Evaluation Circuit Board Layout Design Details

Item	Description
J1 - J4	PC Mount SMA Connector
U1	HMC324MS8G
PCB*	104221 Evaluation PCB 1.5" x 1.5"
*Circuit Board Material: Rogers 4350	

HBT DUAL DRIVER AMPLIFIER DC - 3.0 GHz

v00.1200

FEBRUARY 2001

NOTES:

1

AMPLIFIERS

SMT

