

**Full - Bridge  
NPT IGBT Power Module**

**$V_{CES} = 1200V$   
 $I_C = 15A @ T_c = 80^\circ C$**

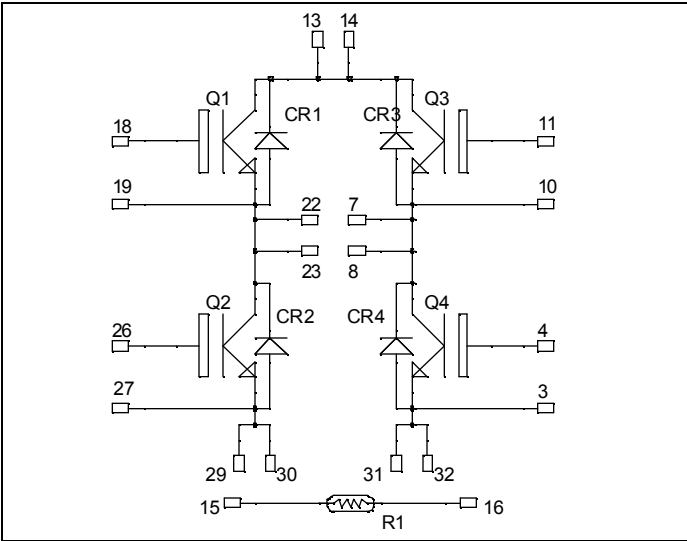

**Application**

- Welding converters
- Switched Mode Power Supplies
- Uninterruptible Power Supplies
- Motor control

**Features**

- Non Punch Through (NPT) Fast IGBT®
  - Low voltage drop
  - Low tail current
  - Switching frequency up to 50 kHz
  - Soft recovery parallel diodes
  - Low diode VF
  - Low leakage current
  - Avalanche energy rated
  - RBSOA and SCSOA rated
  - Symmetrical design
- Kelvin emitter for easy drive
- Very low stray inductance
- High level of integration
- Internal thermistor for temperature monitoring

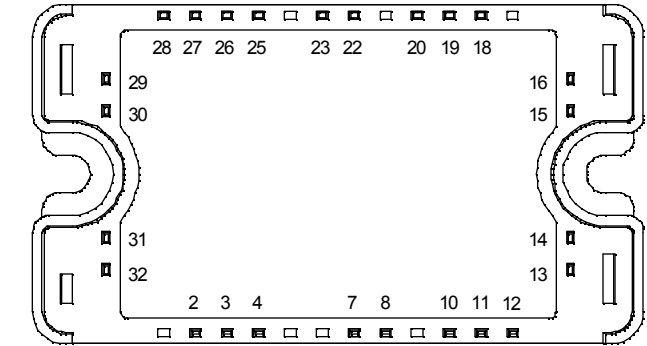

All multiple inputs and outputs must be shorted together  
Example: 13/14 ; 29/30 ; 22/23 ...

**Benefits**

- Outstanding performance at high frequency operation
- Direct mounting to heatsink (isolated package)
- Low junction to case thermal resistance
- Solderable terminals both for power and signal for easy PCB mounting
- Low profile
- Easy paralleling due to positive TC of VCEsat
- Each leg can be easily paralleled to achieve a phase leg of twice the current capability

**Absolute maximum ratings**

Symbol	Parameter	Max ratings	Unit
$V_{CES}$	Collector - Emitter Breakdown Voltage	1200	V
$I_C$	Continuous Collector Current	$T_c = 25^\circ C$	25
		$T_c = 80^\circ C$	15
$I_{CM}$	Pulsed Collector Current	$T_c = 25^\circ C$	60
$V_{GE}$	Gate - Emitter Voltage	$\pm 20$	V
$P_D$	Maximum Power Dissipation	$T_c = 25^\circ C$	140
RBSOA	Reverse Bias Safe Operating Area	$T_j = 125^\circ C$	30A@1150V

**CAUTION:** These Devices are sensitive to Electrostatic Discharge. Proper Handling Procedures Should Be Followed.

All ratings @  $T_j = 25^\circ\text{C}$  unless otherwise specified

## Electrical Characteristics

Symbol	Characteristic	Test Conditions	Min	Typ	Max	Unit
$BV_{CES}$	Collector - Emitter Breakdown Voltage	$V_{GE} = 0\text{V}, I_C = 500\mu\text{A}$	1200			V
$I_{CES}$	Zero Gate Voltage Collector Current	$V_{GE} = 0\text{V}$		1	500	$\mu\text{A}$
		$V_{CE} = 1200\text{V}$		1		$\text{mA}$
$V_{CE(on)}$	Collector Emitter on Voltage	$V_{GE} = 15\text{V}$	2.5	3.2	3.7	V
		$I_C = 15\text{A}$		4.0		
$V_{GE(th)}$	Gate Threshold Voltage	$V_{GE} = V_{CE}, I_C = 1\text{mA}$	4		6	V
$I_{GES}$	Gate - Emitter Leakage Current	$V_{GE} = 20\text{V}, V_{CE} = 0\text{V}$			400	$\text{nA}$

## Dynamic Characteristics

Symbol	Characteristic	Test Conditions	Min	Typ	Max	Unit
$C_{ies}$	Input Capacitance	$V_{GE} = 0\text{V}$		1000		$\text{pF}$
$C_{oes}$	Output Capacitance	$V_{CE} = 25\text{V}$		150		
$C_{res}$	Reverse Transfer Capacitance	$f = 1\text{MHz}$		70		
$Q_g$	Total gate Charge	$V_{GE} = 15\text{V}$		99		$\text{nC}$
$Q_{ge}$	Gate - Emitter Charge	$V_{Bus} = 300\text{V}$		10		
$Q_{gc}$	Gate - Collector Charge	$I_C = 15\text{A}$		70		
$T_{d(on)}$	Turn-on Delay Time	Inductive Switching ( $25^\circ\text{C}$ ) $V_{GE} = 15\text{V}$ $V_{Bus} = 400\text{V}$ $I_C = 15\text{A}$ $R_G = 33\Omega$		60		$\text{ns}$
$T_r$	Rise Time			50		
$T_{d(off)}$	Turn-off Delay Time			315		
$T_f$	Fall Time			30		
$T_{d(on)}$	Turn-on Delay Time	Inductive Switching ( $125^\circ\text{C}$ ) $V_{GE} = 15\text{V}$ $V_{Bus} = 400\text{V}$ $I_C = 15\text{A}$ $R_G = 33\Omega$		60		$\text{ns}$
$T_r$	Rise Time			50		
$T_{d(off)}$	Turn-off Delay Time			356		
$T_f$	Fall Time			40		
$E_{on}$	Turn-on Switching Energy ①				2	
$E_{off}$	Turn-off Switching Energy ②			1	$\text{mJ}$	

①  $E_{on}$  includes diode reverse recovery

② In accordance with JEDEC standard JESD24-1

## Reverse diode ratings and characteristics

Symbol	Characteristic	Test Conditions	Min	Typ	Max	Unit
$V_{RRM}$	Maximum Peak Repetitive Reverse Voltage		1200			V
$I_{RM}$	Maximum Reverse Leakage Current	$V_R = 1200\text{V}$			250	$\mu\text{A}$
					500	
$I_{F(AV)}$	Maximum Average Forward Current	50% duty cycle		15		A
$V_F$	Diode Forward Voltage	$I_F = 15\text{A}$		2.9	3.4	V
		$V_{GE} = 0\text{V}$		2.6		
$t_{rr}$	Reverse Recovery Time	$I_F = 15\text{A}$		0.5		$\mu\text{s}$
$Q_{rr}$	Reverse Recovery Charge	$V_R = 600\text{V}$		0.4		$\mu\text{C}$
		$di/dt = 400\text{A}/\mu\text{s}$		1.2		

**Temperature sensor NTC**

*Symbol Characteristic*

		<i>Min</i>	<i>Typ</i>	<i>Max</i>	<i>Unit</i>
R <sub>25</sub>	Resistance @ 25°C		68		kΩ
B <sub>25/85</sub>	T <sub>25</sub> = 298.16 K		4080		K

$$R_T = \frac{R_{25}}{\exp\left[B_{25/85}\left(\frac{1}{T_{25}} - \frac{1}{T}\right)\right]}$$

T: Thermistor temperature  
R<sub>T</sub>: Thermistor value at T

**Thermal and package characteristics**

*Symbol Characteristic*

		<i>Min</i>	<i>Typ</i>	<i>Max</i>	<i>Unit</i>	
R <sub>thJC</sub>	Junction to Case	IGBT		0.9	°C/W	
		Diode		2.0		
V <sub>ISOL</sub>	RMS Isolation Voltage, any terminal to case t=1 min, I <sub>isol</sub> <1mA, 50/60Hz	2500			V	
T <sub>J</sub>	Operating junction temperature range	-40		150	°C	
T <sub>STG</sub>	Storage Temperature Range	-40		125		
T <sub>C</sub>	Operating Case Temperature	-40		100		
Torque	Mounting torque		To heatsink	M4	4.7	N.m
Wt	Package Weight				110	g

**Package outline**

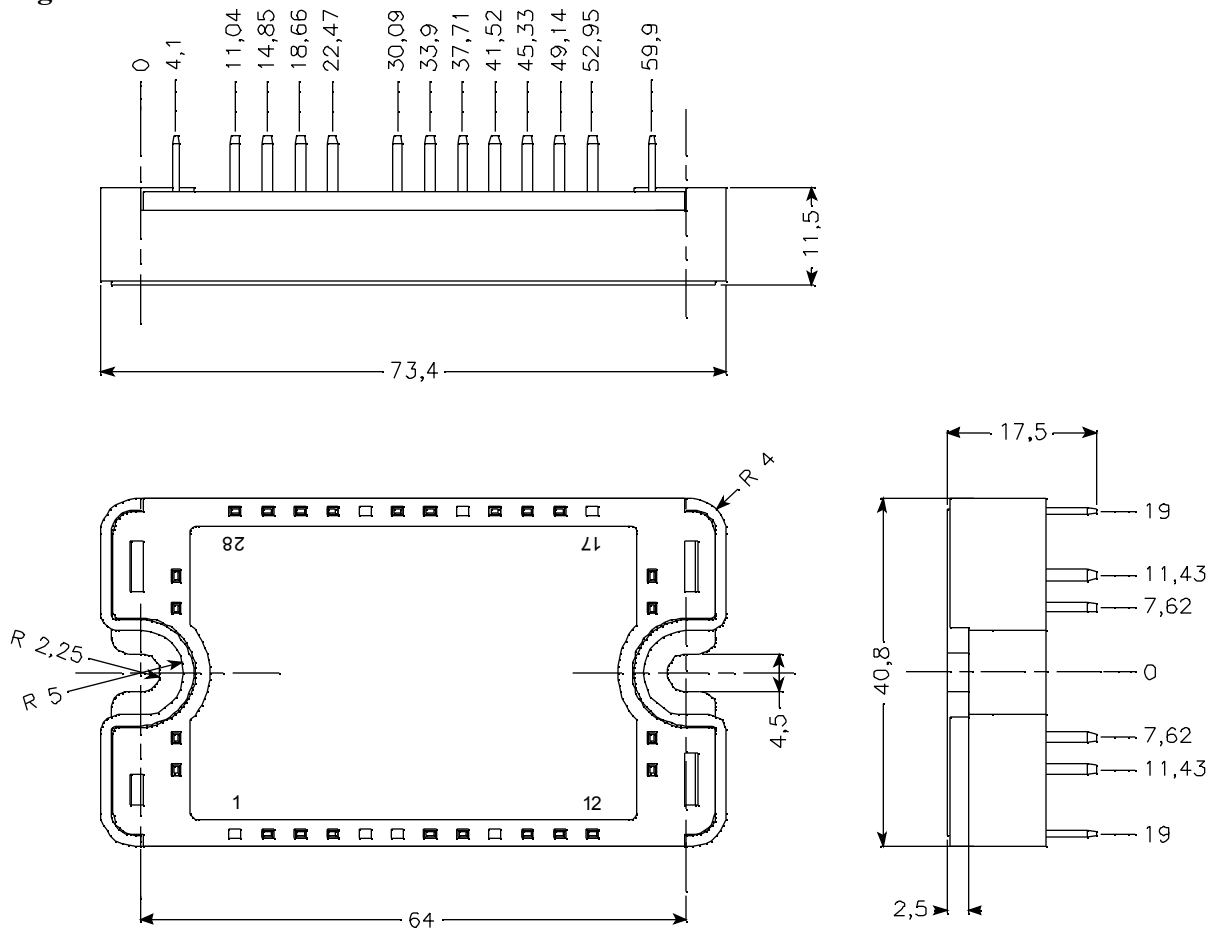

**Typical Performance Curve**

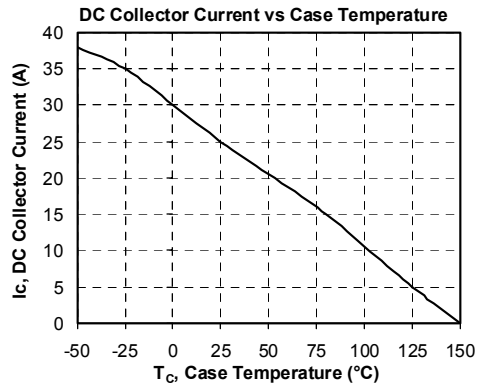
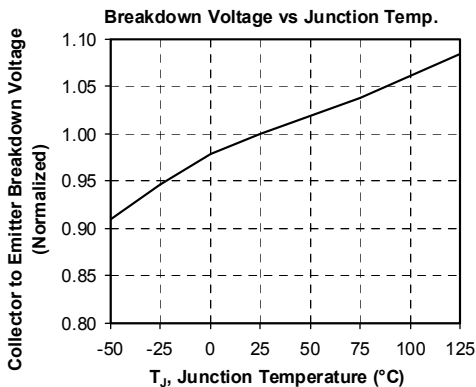
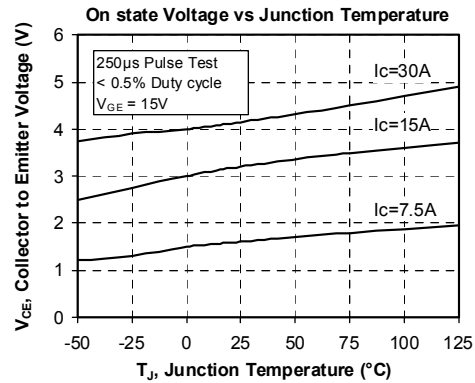
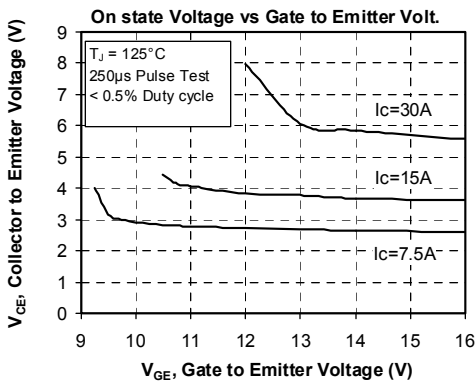
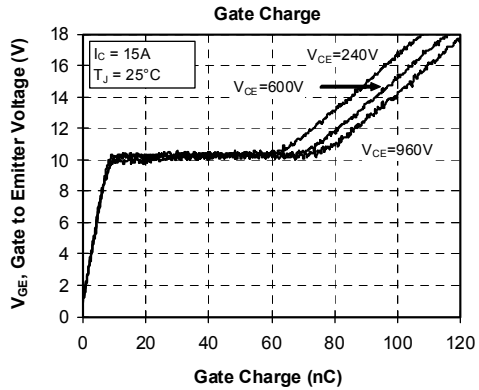
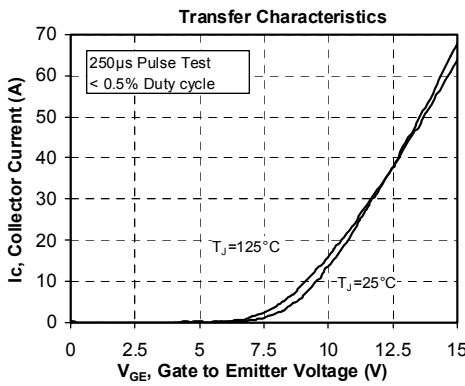
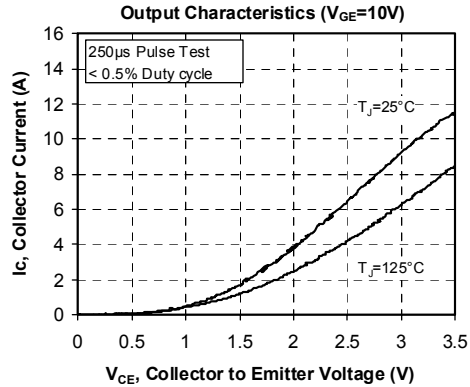
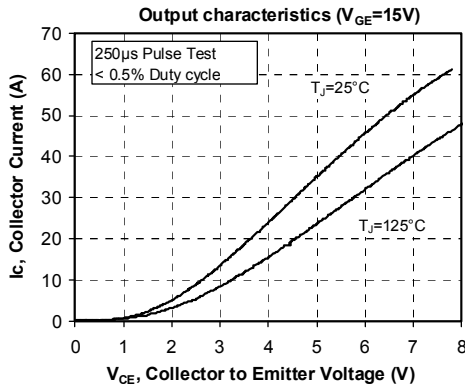

Turn-On Delay Time vs Collector Current

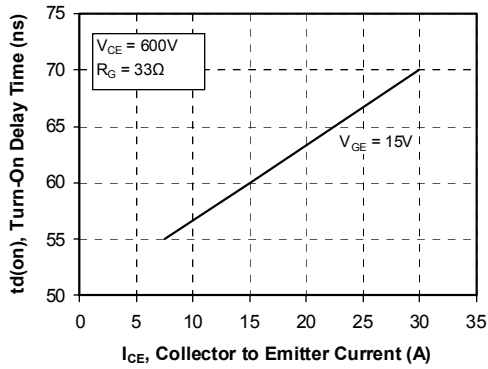

Turn-Off Delay Time vs Collector Current

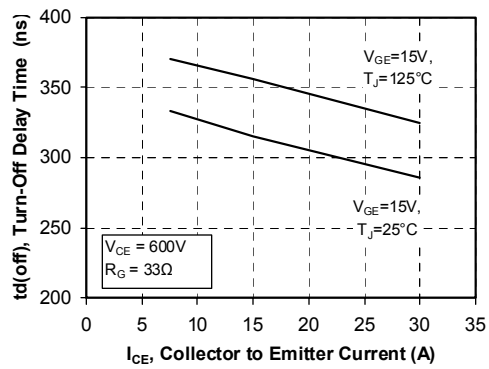

Current Rise Time vs Collector Current

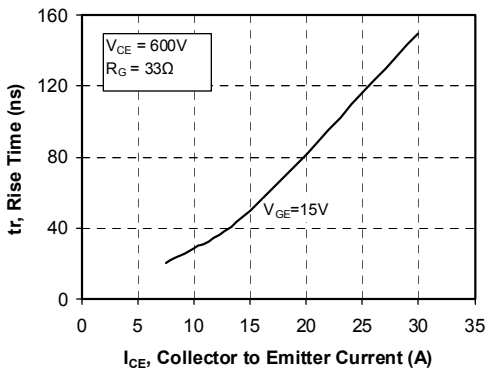

Current Fall Time vs Collector Current

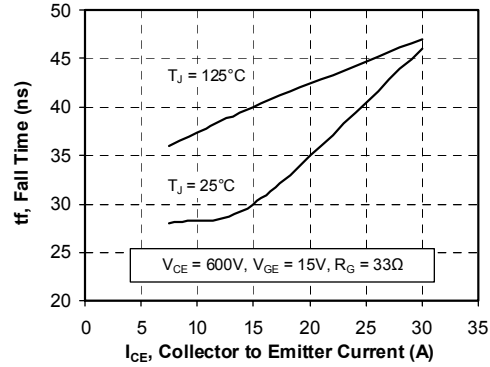

Turn-On Energy Loss vs Collector Current

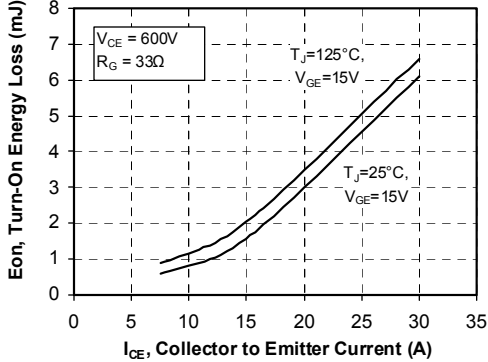

Turn-Off Energy Loss vs Collector Current

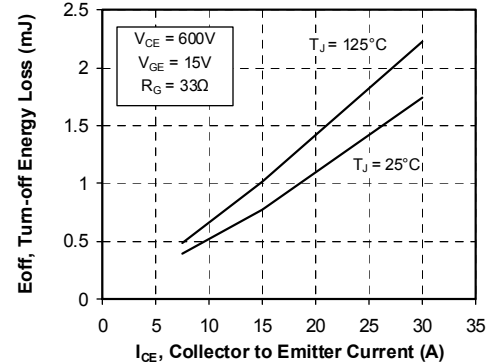

Switching Energy Losses vs Gate Resistance

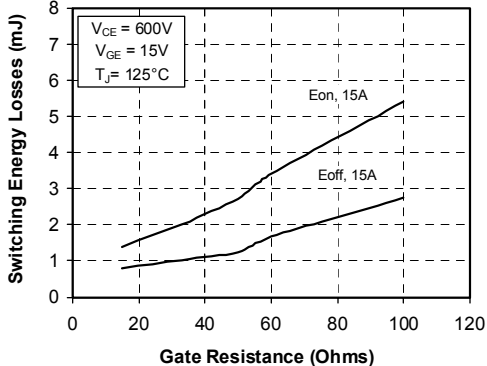

Minimum Switching Safe Operating Area

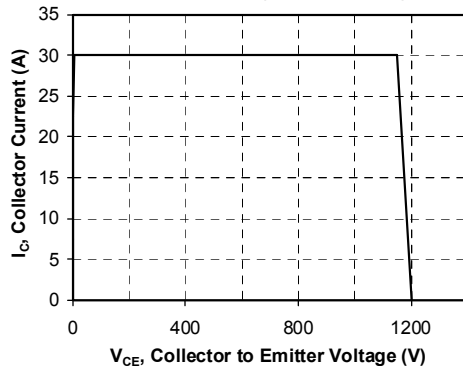

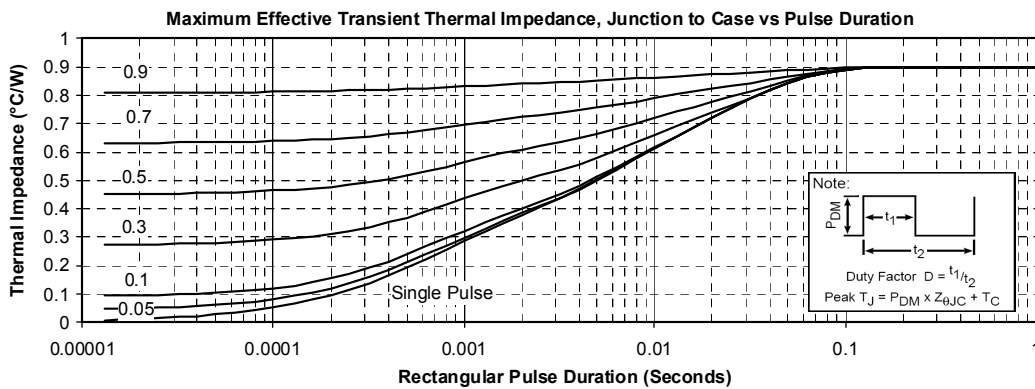
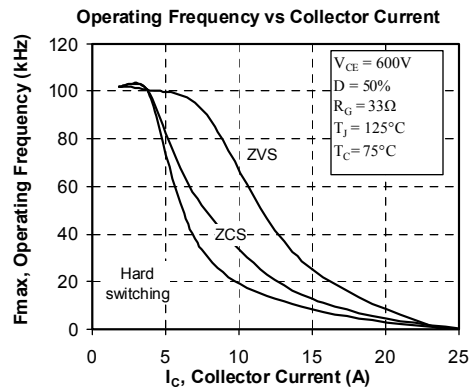
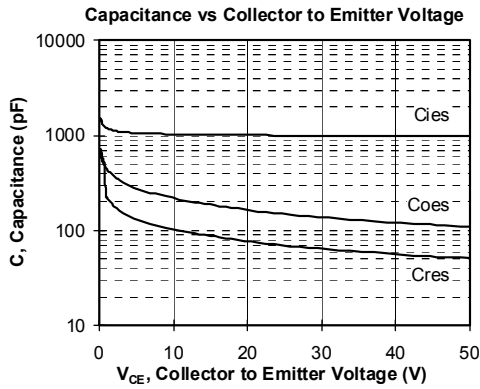

APT reserves the right to change, without notice, the specifications and information contained herein

APT's products are covered by one or more of U.S. patents 4,895,810 5,045,903 5,089,434 5,182,234 5,019,522 5,262,336 6,503,786 5,256,583 4,748,103 5,283,202 5,231,474 5,434,095 5,528,058 and foreign patents. U.S. and Foreign patents pending. All Rights Reserved.