

LTR	REVISION	DATE	APPD
-	RELEASED	06-22-05	

Actual Size

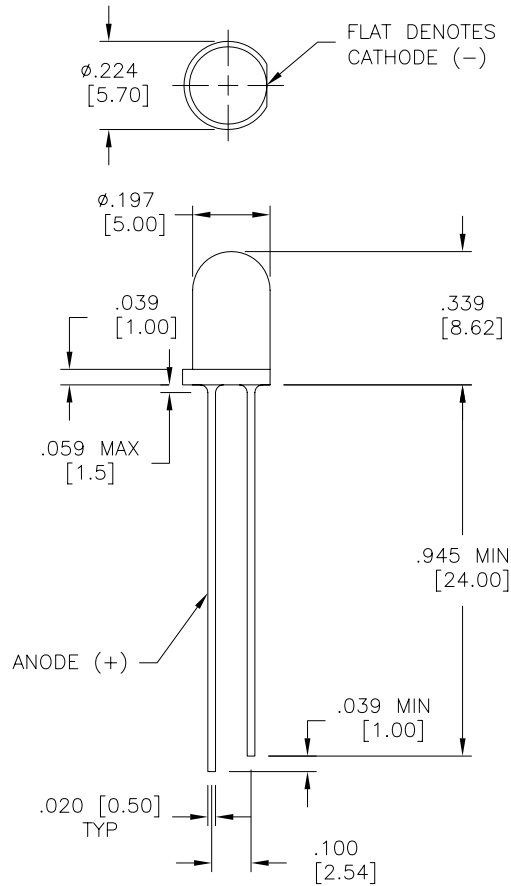
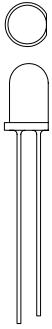

NOTES:

1. ALL DIMS ARE IN INCHES (MILLIMETERS).
2. TOLERANCE IS ± 0.010 " (± 0.25 mm) UNLESS OTHERWISE SPECIFIED.
3. LEAD SPACING IS MEASURED WHERE LEADS EMERGE FROM THE PACKAGE.
4. LEADS TO BE SOLDERABLE AND CAPABLE OF MEETING THE SOLDERABILITY REQUIREMENTS OF MIL-STD-202, METHOD 208.
5. MANUFACTURE DATE SHALL NOT BE OLDER THAN 26 WEEKS (6 MONTHS).

LEDTRONICS PART NO.	L.E.D. RADIATION COLOR	L.E.D. APPEARANCE	ABSOLUTE MAXIMUM RATINGS (Ta=25°C)					ELECTRO-OPTICAL CHARACTERISTICS (Ta=25°C)						
			Pd mW	Ifp* mA	If mA	Vr V	Topr (°C)	If mA	Iv mcd typ	Vf=V typ/max	VIEW ANGLE 201/2	Ir max μA	Δλ nm	λPeak nm
L200CWR3KF-15D	ULTRA RED	WATER CLEAR	80	150	30	5	-40 TO +80	20	1250	2.0/2.6	12/15	100	20	660
L200CWR3KF-30D	ULTRA RED	WATER CLEAR	80	150	30	5	-40 TO +80	20	1050	2.0/2.6	20	100	20	660

Tstg: -40°C TO +85°C *Condition for Ifp is pulse of 1/10 duty and 0.1msec width.
 LEAD SOLDERING TEMP: [1.6mm (.063in) FROM BODY] 260°C FOR 5 SEC.

 LEDTRONICS, INC. 23105 KASHIWA COURT TORRANCE, CA 90505	-PROPRIETARY- This document contains Proprietary information of LEDTRONICS, INC. It may not be copied, used or disclosed for any purpose without the prior express written consent of LEDTRONICS, INC.	TITLE L200CWR3KF-XXD			
	.XXX ± .010 TOLERANCE PER ANSI-Y14.5 .XX ± .025 (UNLESS OTHERWISE STATED) ANGLES ± 0°,30' FRACT. ± 1/32	DWG NO DSDC0355	SCALE 1:1	SHEET 1 OF 2	DATE 06-22-05
	CODE IDENT NO. 8Z410	DWG BY SMA	CHK BY PL 06-22-05	QA MNFG	CUSTOMER

Fig.1 Relative intensity vs. Wavelength

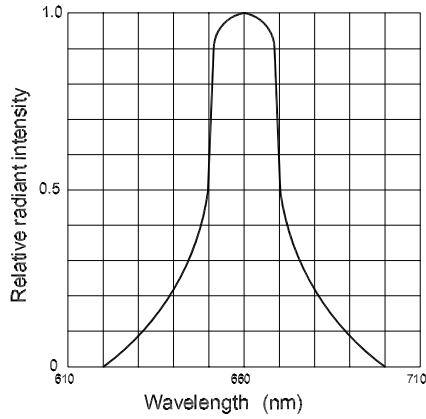

Fig.2 Forward current derating curve vs. Ambient temperature

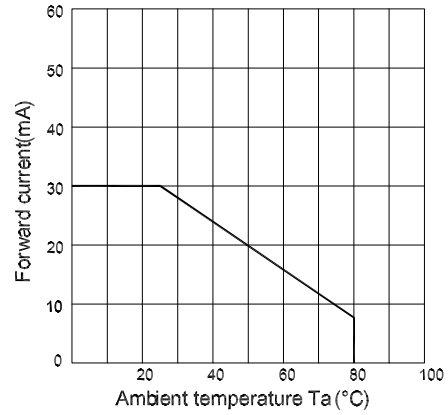

Fig.3 Forward current vs. Forward voltage

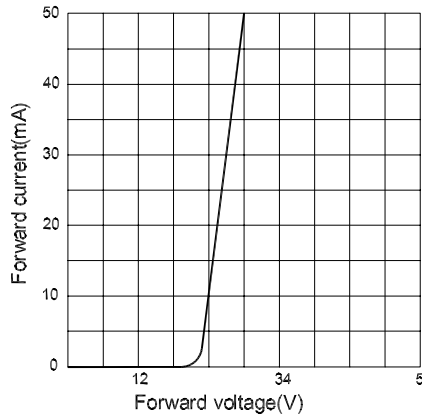

Fig.4 Relative luminous intensity vs. Ambient temperature

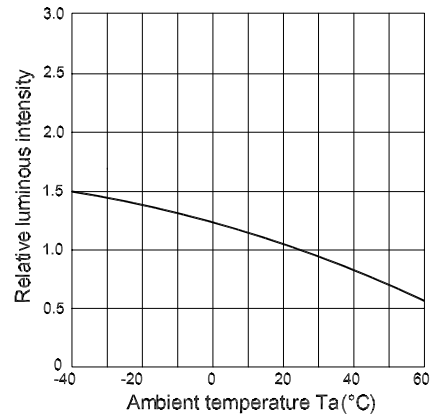

Fig.5 Relative uminous intensity vs. Forwardcurrent

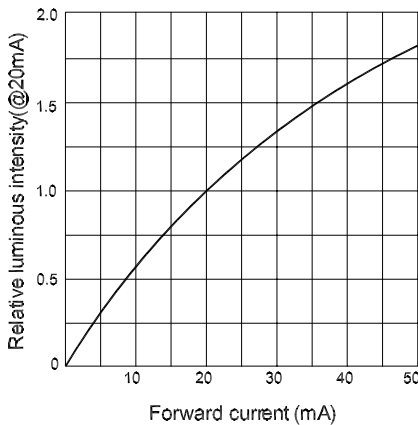

Fig.6 Radiation diagram for L200CWR3KF-15D

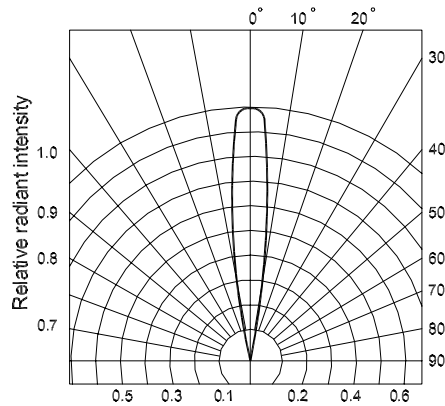

Fig.6 Radiation diagram for L200CWR3KF-30D

