

SHINDENGEN

Schottky Rectifiers (SBD)

SBD Bridges

D15XBS6

60V 15A

FEATURES

- Thin Single In-Line Package
- SBD Bridge
- Low VF

OUTLINE DIMENSIONS

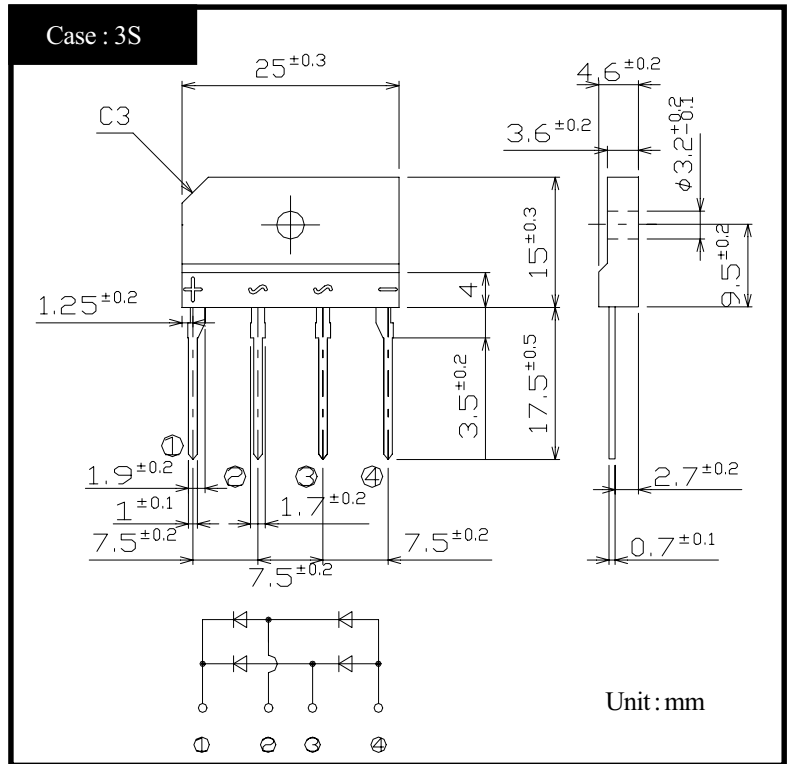

RATINGS

● Absolute Maximum Ratings (If not specified Tc=25°C)

Item	Symbol	Conditions	Ratings	Unit
Storage Temperature	Tstg		-55~150	°C
Operating Junction Temperature	Tj		150	°C
Maximum Reverse Voltage	V _{RM}		60	V
Repetitive Peak Surge Reverse Voltage	V _{RRSM}	Pulse width 0.5ms, duty 1/40	65	V
Average Rectified Forward Current	I _O	50Hz sine wave, R-load With heatsink Tc=59°C	15	A
		50Hz sine wave, R-load Without heatsink Ta=25°C	2.1	
Peak Surge Forward Current	I _{FSM}	50Hz sine wave, Non-repetitive 1cycle peak value, Tj=25°C	150	A
Repetitive Peak Surge Reverse Power	P _{RRSM}	Pulse width 10is, Rating of per diode, Tj=25°C	330	W
Dielectric Strength	Vdis	Terminals to case, AC 1 minute	2	kV
Mounting Torque	TOR	(Recommended torque: 0.5N·m)	0.8	N·m

● Electrical Characteristics (If not specified Tc=25°C)

Item	Symbol	Conditions	Ratings	Unit
Forward Voltage	V _F	I _F =7.5A, Pulse measurement, Rating of per diode	Max.0.63	V
Reverse Current	I _R	V _R =60V, Pulse measurement, Rating of per diode	Max.6	mA
Junction Capacitance	C _j	f=1MHz, V _R =10V, Rating of per arm	TYP 410	pF
Thermal Resistance	θ _{jc}	junction to case With heatsink	Max.3.5	°C/W
	θ _{jl}	junction to lead	Max.6	
	θ _{ja}	junction to ambient	Max.30	

D15XBS6

Forward Voltage

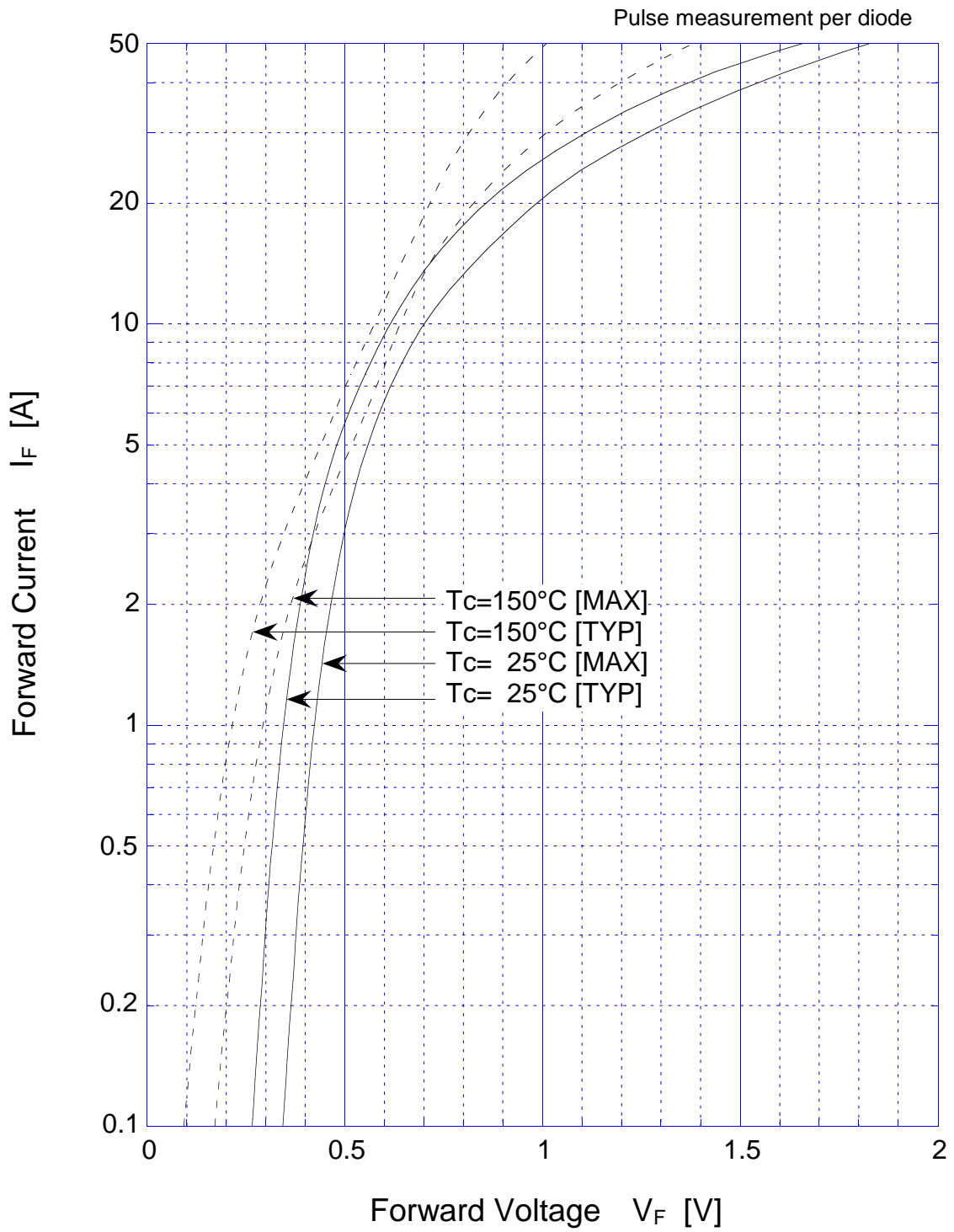

D15XBS6

Forward Power Dissipation

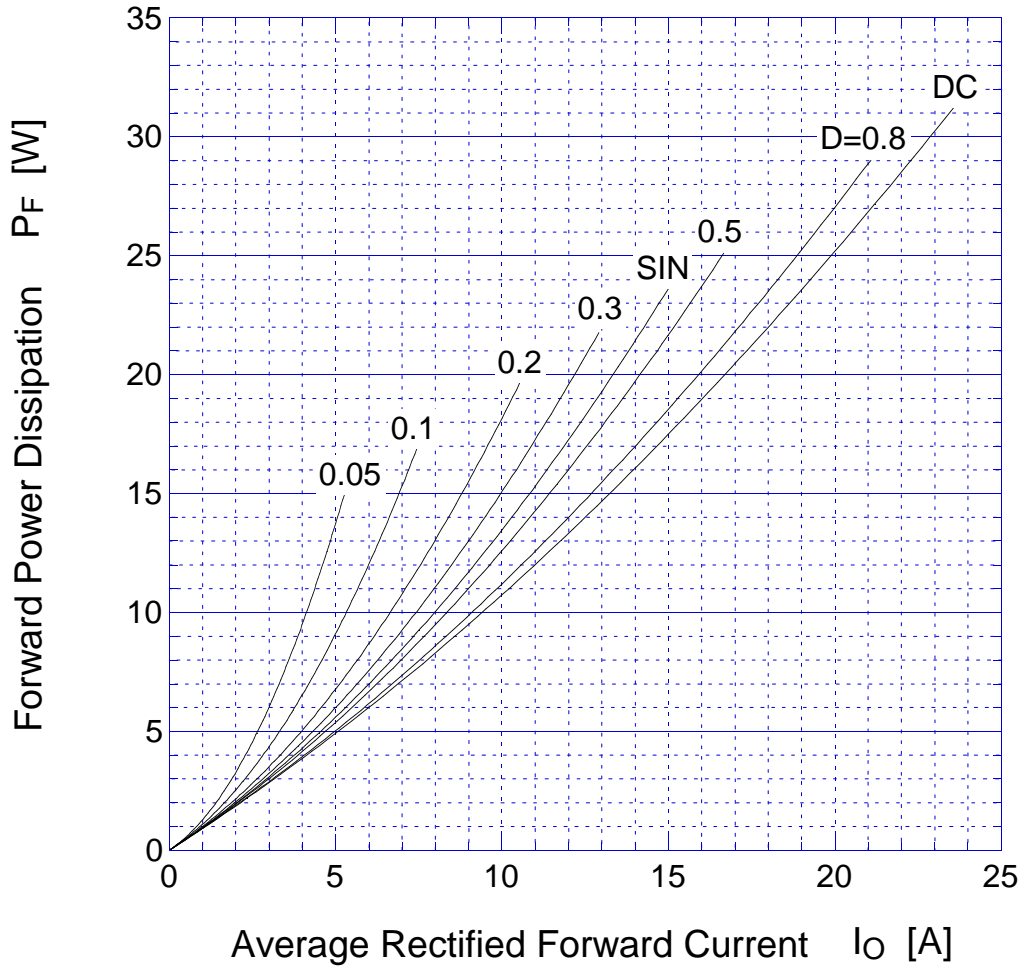

$T_j = 150^\circ\text{C}$

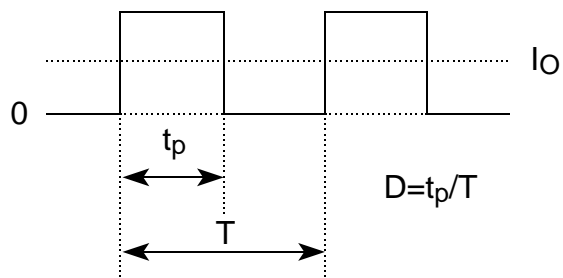

D15XBS6 Peak Surge Forward Capability

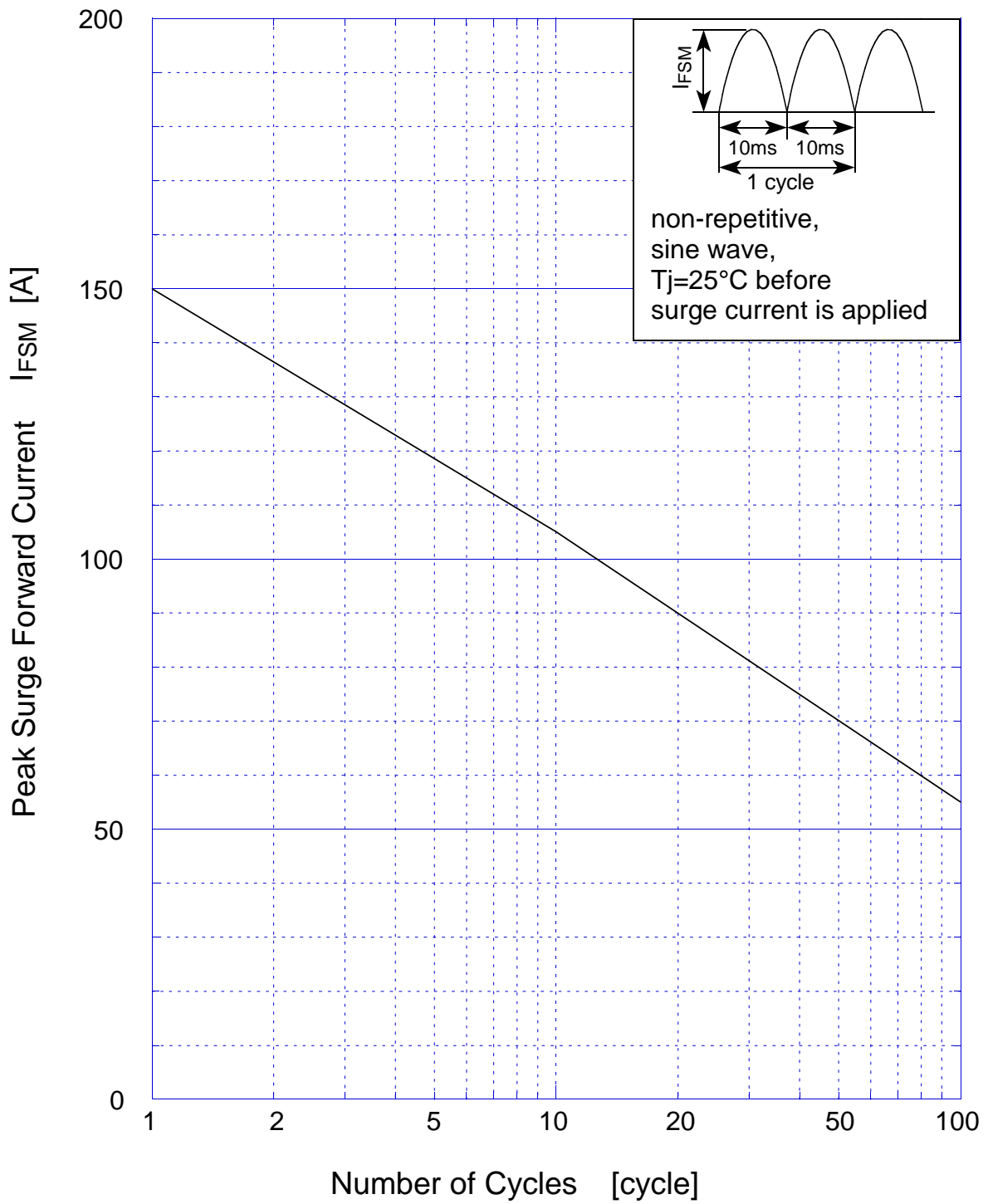

D15XBS6 Reverse Current

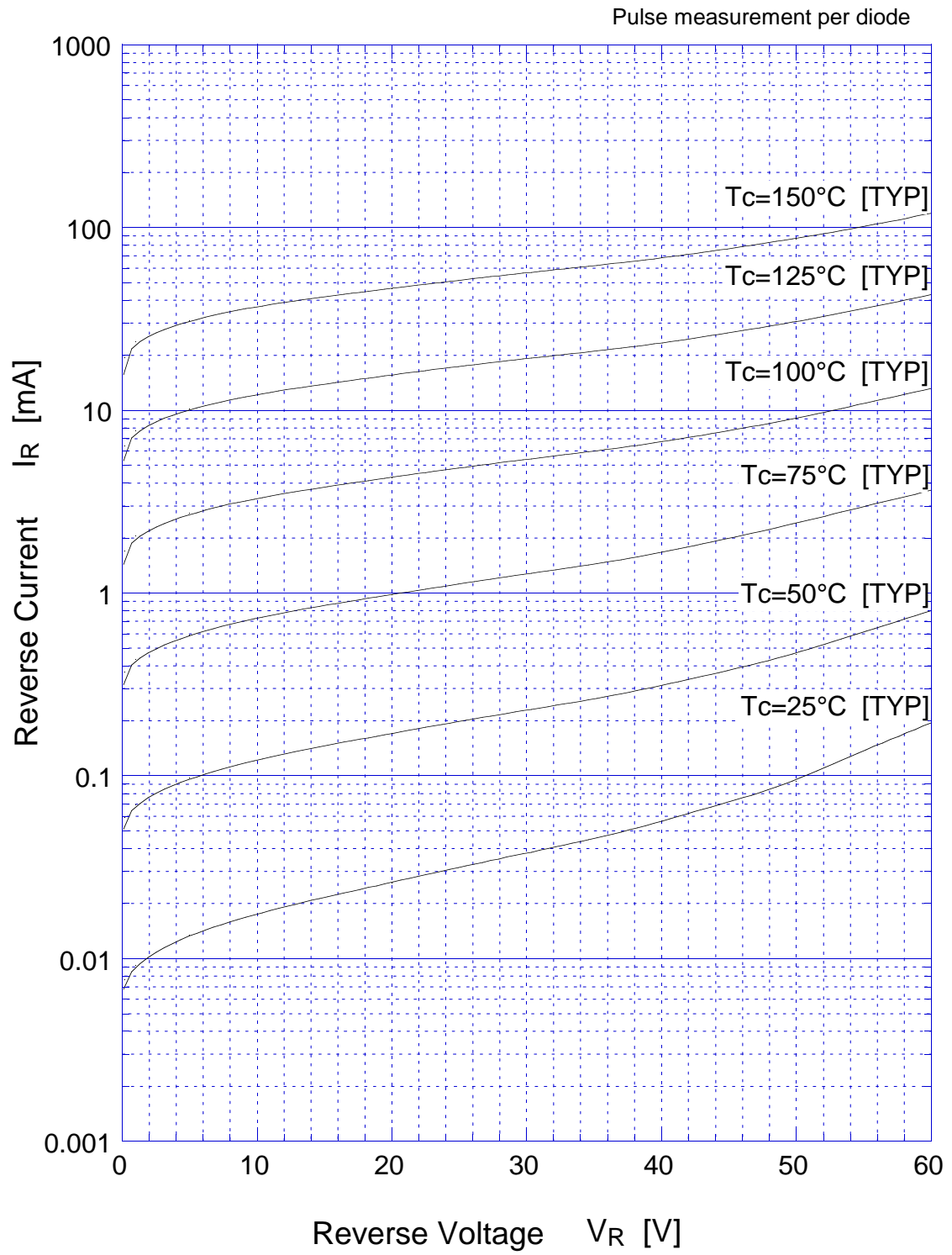

D15XBS6 Reverse Power Dissipation

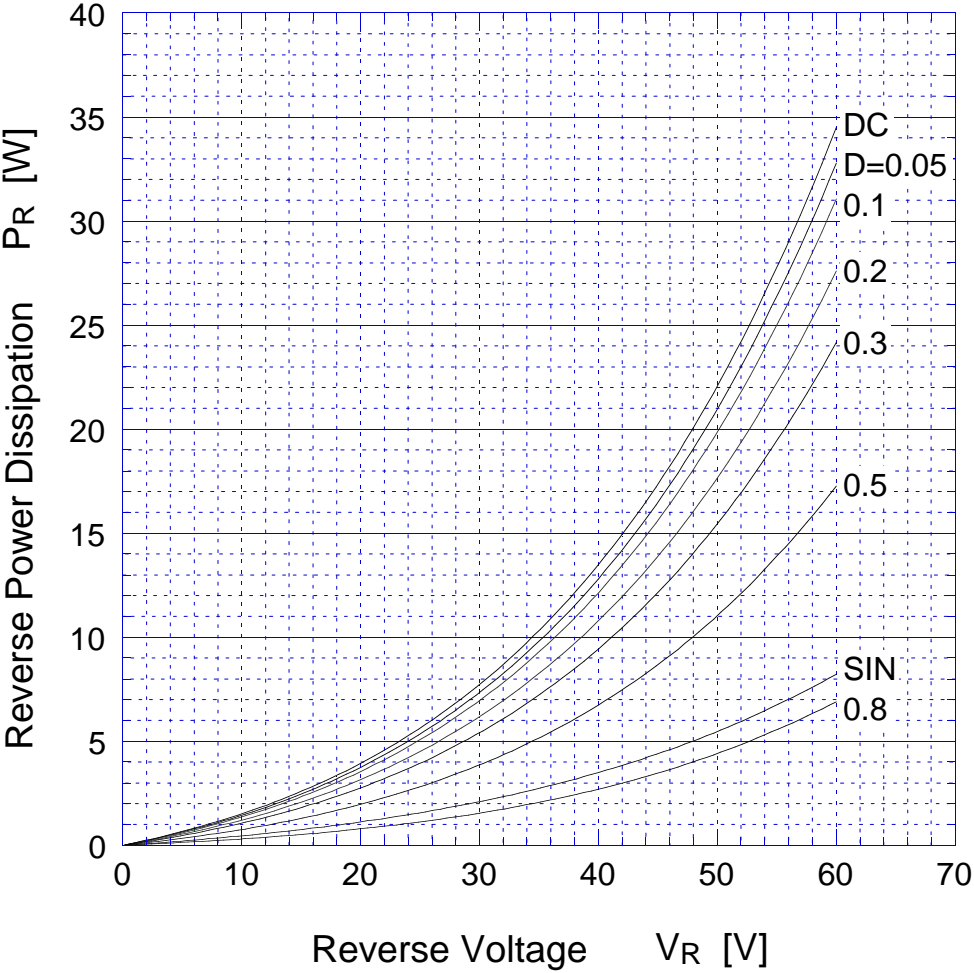

$T_j = 150^\circ\text{C}$

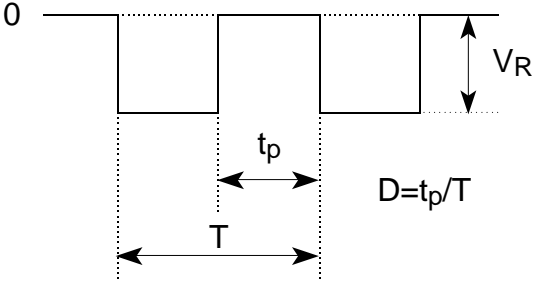

D15XBS6 Peak Surge Forward Capability

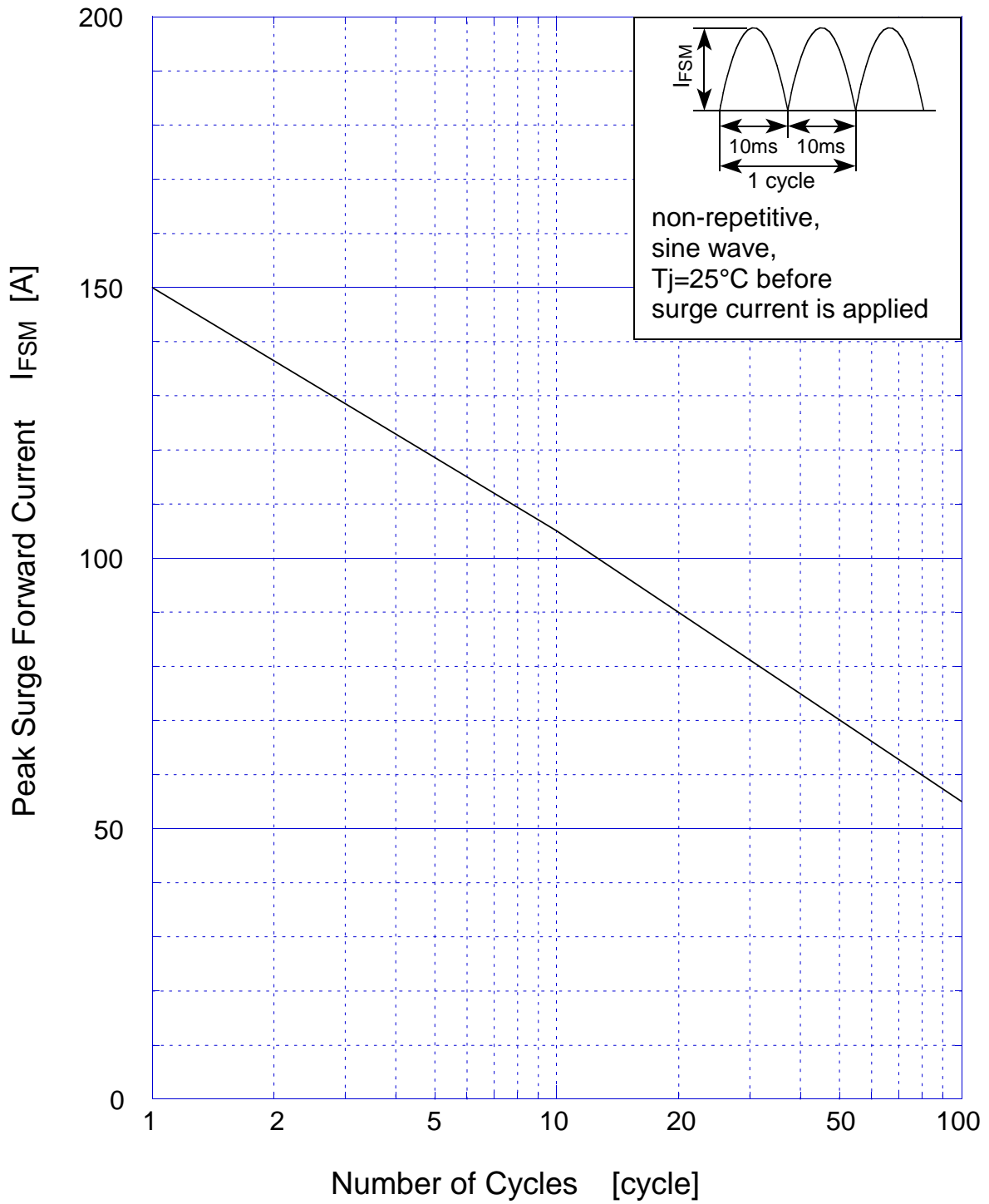

D15XBS6

Derating Curve

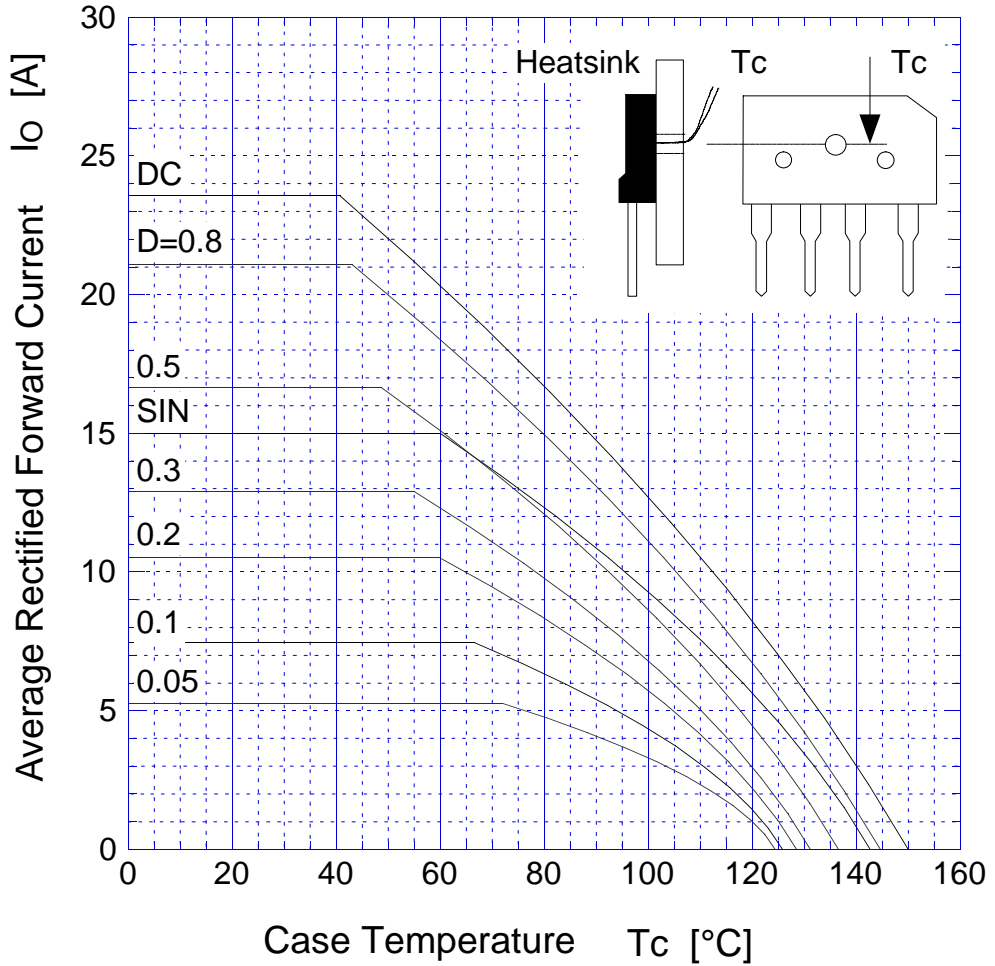

$V_R = 30V$

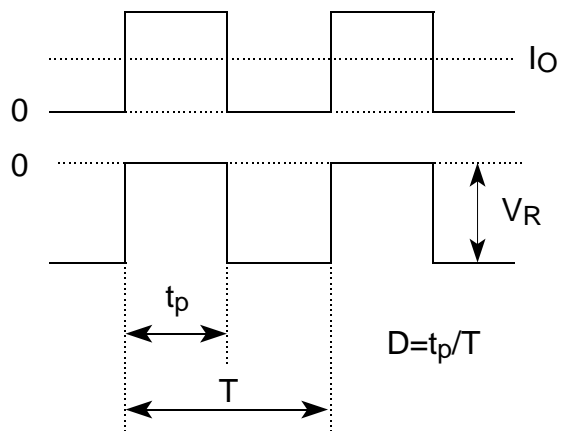

D15XBS6

Derating Curve

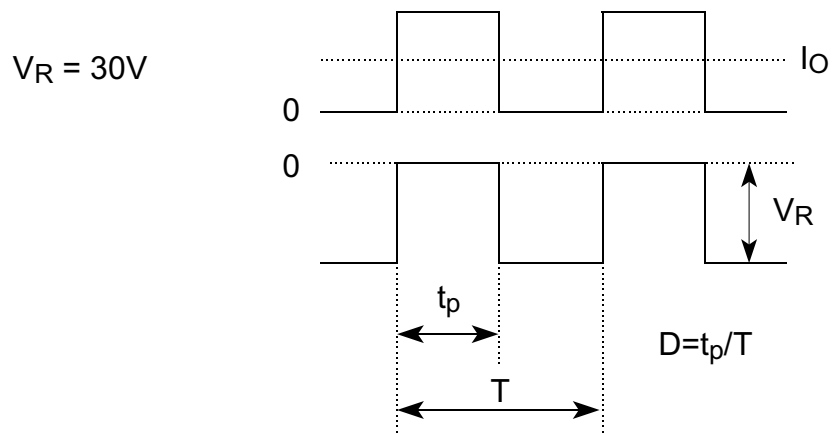
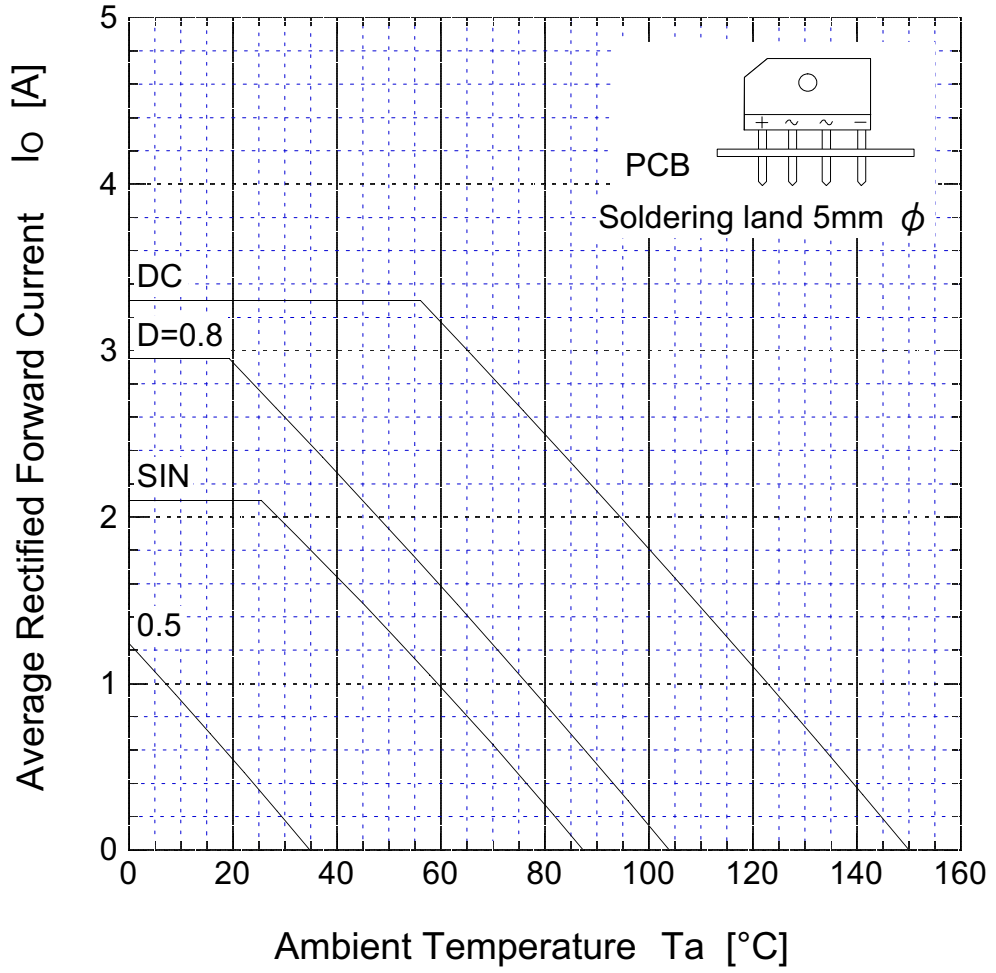

D15XBS6 Repetitive Surge Reverse Power Capability

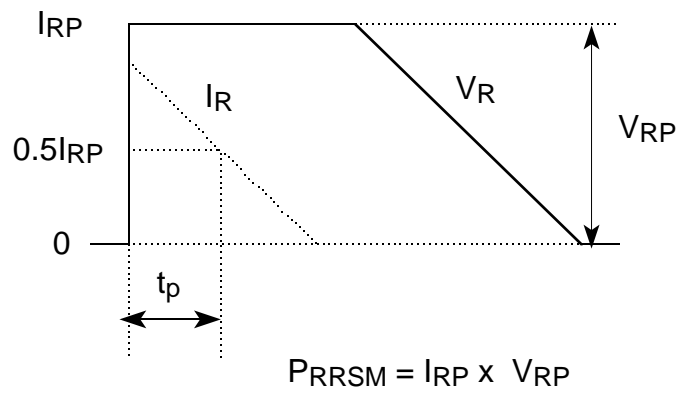
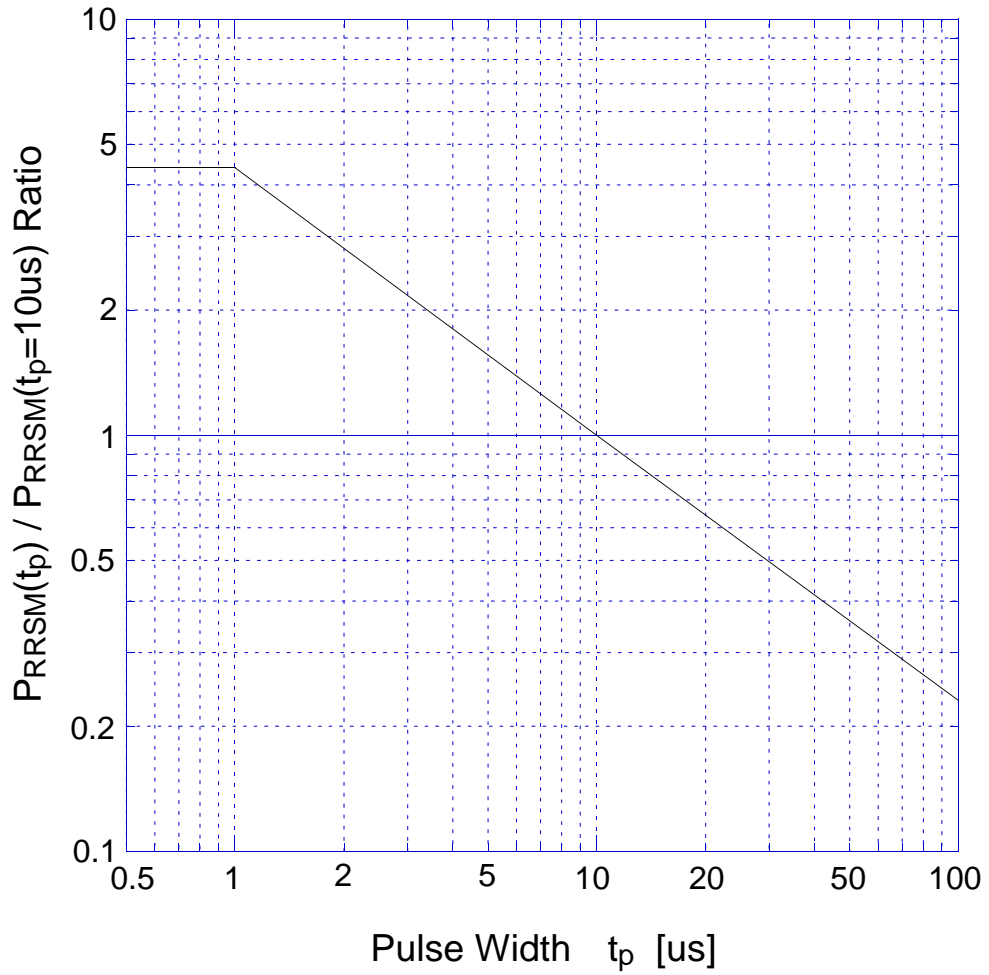

D15XBS6 Repetitive Surge Reverse Power Derating Curve

