

SANYO	No.4227	2SK1909
		N-Channel MOS Silicon FET Very High-Speed Switching Applications

Features

- Low ON resistance.
- Very high-speed switching.
- Low-voltage drive.
- Surface mount type device making the following possible.
 - Reduction in the number of manufacturing processes for 2SK1909-applied equipment.
 - High density surface mount applications.
 - Small size of 2SK1909-applied equipment.

Absolute Maximum Ratings at Ta = 25°C

Drain to Source Voltage	V_{DSS}		100	V	
Gate to Source Voltage	V_{GSS}		±15	V	
Drain Current(DC)	I_D		25	A	
Drain Current(Pulse)	I_{DP}	$PW \leq 10\mu s, \text{ duty cycle} \leq 1\%$	100	A	
Allowable Power Dissipation	P_D		1.65	W	
		$T_c = 25^\circ C$	70	W	
Channel Temperature	T_{ch}		150	°C	
Storage Temperature	T_{stg}		-55 to +150	°C	

Electrical Characteristics at Ta = 25°C

			min	typ	max	
D-S Breakdown Voltage	$V_{(BR)DSS}$	$I_D = 1mA, V_{GS} = 0$	100			V
G-S Breakdown Voltage	$V_{(BR)GSS}$	$I_G = \pm 100\mu A, V_{DS} = 0$	±15			V
Zero Gate Voltage Drain Current	I_{DSS}	$V_{DS} = 100V, V_{GS} = 0$			100	μA
Gate to Source Leakage Current	I_{GSS}	$V_{GS} = \pm 12V, V_{DS} = 0$			±10	μA
Cutoff Voltage	$V_{GS(off)}$	$V_{DS} = 10V, I_D = 1mA$	1.0		2.0	V
Forward Transfer Admittance	$ Y_{fs} $	$V_{DS} = 10V, I_D = 12A$	15	24.5		S
Static Drain to Source on State Resistance	$R_{DS(on)}$	$I_D = 12A, V_{GS} = 10V$		60	80	mΩ
	$R_{DS(on)}$	$I_D = 12A, V_{GS} = 4V$		80	110	mΩ

Continued on next page.

Package Dimensions 2093

(unit : mm)

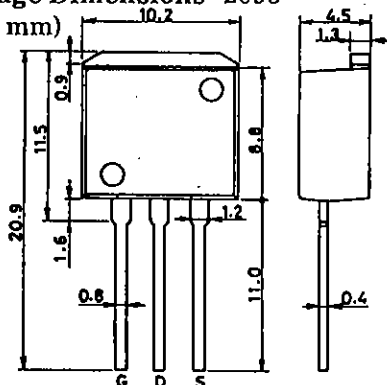

G : Gate
D : Drain
S : Source
SANYO : SMP

Package Dimensions 2090

(unit : mm)

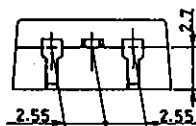
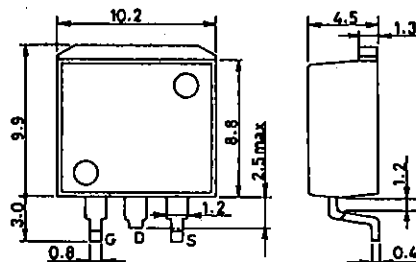

G : Gate
D : Drain
S : Source
SANYO : SMP-FD

SANYO Electric Co., Ltd. Semiconductor Business Headquarters
TOKYO OFFICE Tokyo Bldg., 1-10, 1 Chome, Ueno, Taito-ku, TOKYO, 110 JAPAN

Continued from preceding page.

			min	typ	max	unit
Input Capacitance	C_{iss}	$V_{DS} = 20V, f = 1MHz$		1900		pF
Output Capacitance	C_{oss}	$V_{DS} = 20V, f = 1MHz$		300		pF
Reverse Transfer Capacitance	C_{rss}	$V_{DS} = 20V, f = 1MHz$		60		pF
Turn-ON Delay Time	$t_{d(on)}$	See specified Test Circuit.		15		ns
Rise Time	t_r	"		20		ns
Turn-OFF Delay Time	$t_{d(off)}$	"		290		ns
Fall Time	t_f	"		100		ns
Diode Forward Voltage	V_{SD}	$I_S = 25A, V_{GS} = 0$	1.0	1.5		V

Switching Time Test Circuit

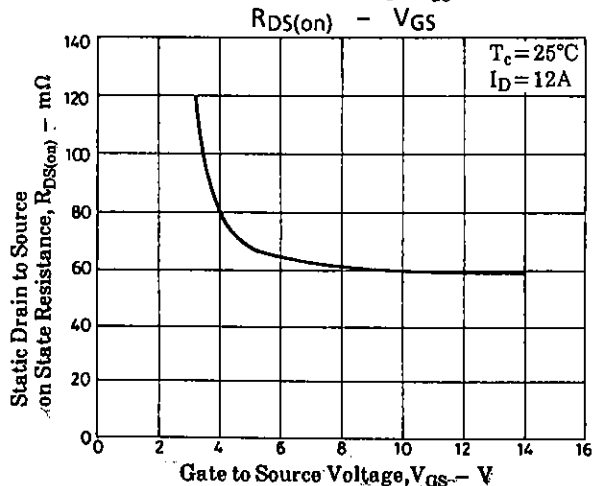
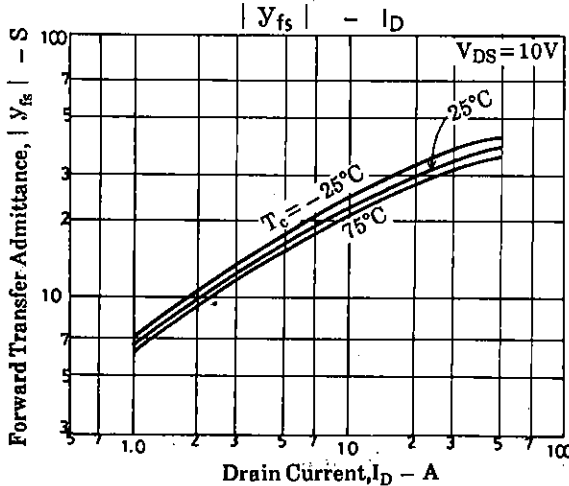
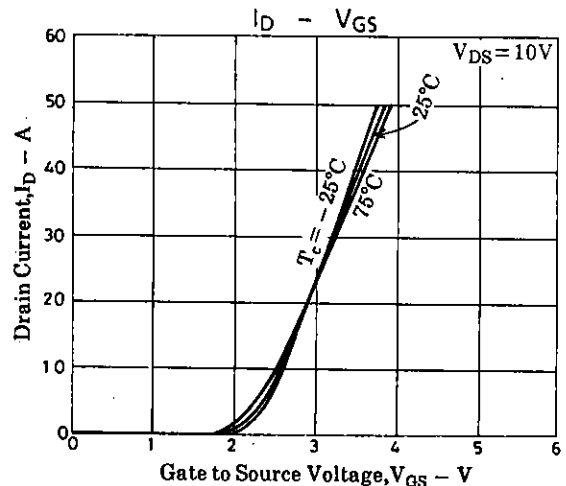
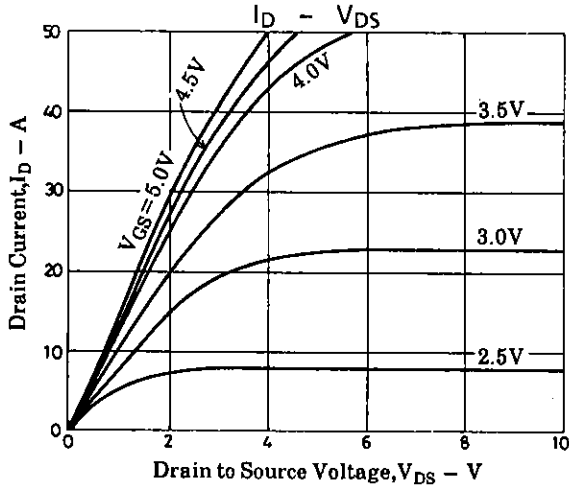
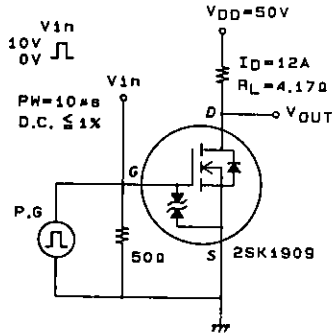

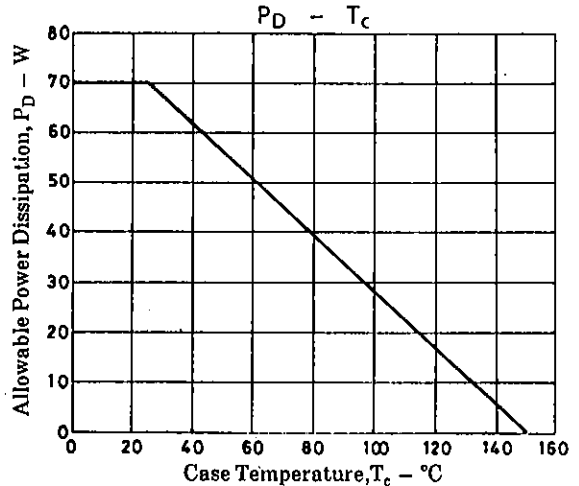
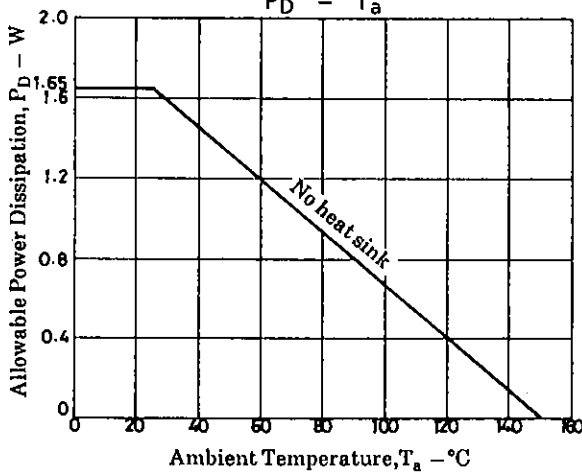
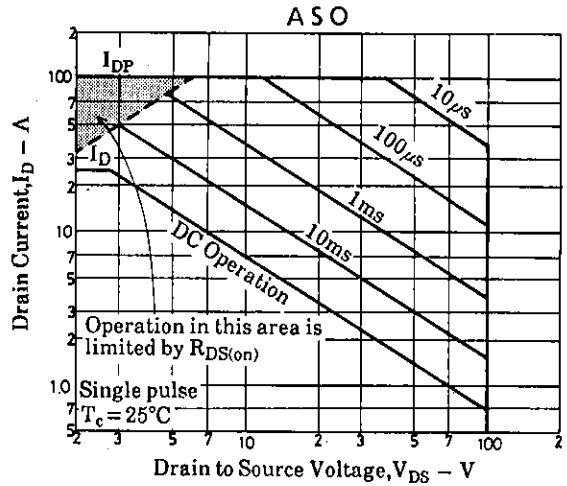
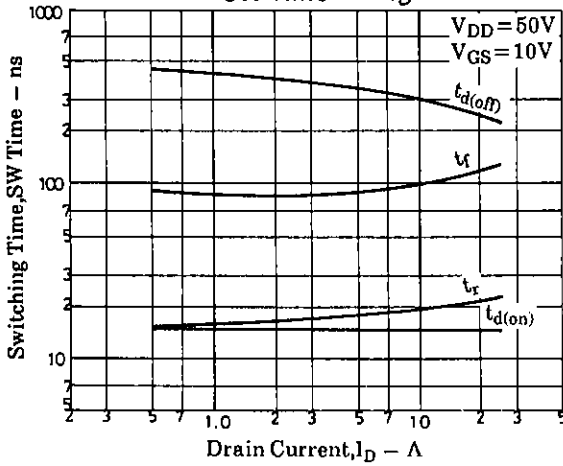
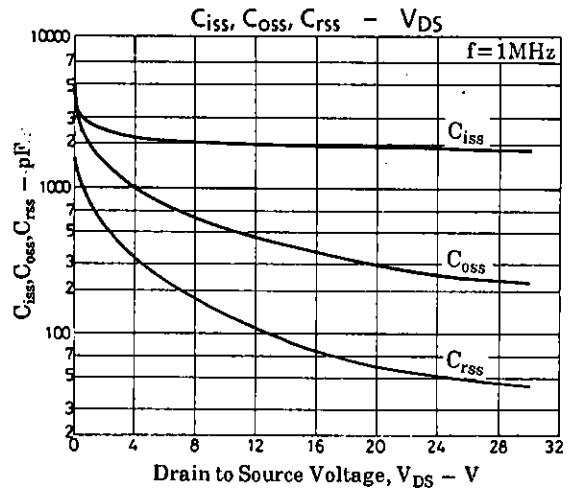
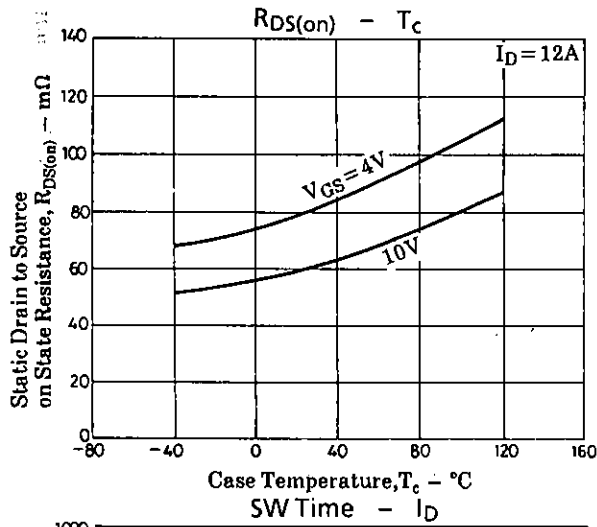

- No products described or contained herein are intended for use in surgical implants, life-support systems, aerospace equipment, nuclear power control systems, vehicles, disaster/crime-prevention equipment and the like, the failure of which may directly or indirectly cause injury, death or property loss.
- Anyone purchasing any products described or contained herein for an above-mentioned use shall:
 - ① Accept full responsibility and indemnify and defend SANYO ELECTRIC CO., LTD., its affiliates, subsidiaries and distributors and all their officers and employees, jointly and severally, against any and all claims and litigation and all damages, cost and expenses associated with such use:
 - ② Not impose any responsibility for any fault or negligence which may be cited in any such claim or litigation on SANYO ELECTRIC CO., LTD., its affiliates, subsidiaries and distributors or any of their officers and employees jointly or severally.
- Information (including circuit diagrams and circuit parameters) herein is for example only; it is not guaranteed for volume production. SANYO believes information herein is accurate and reliable, but no guarantees are made or implied regarding its use or any infringements of intellectual property rights or other rights of third parties.