

GaAs PHEMT MMIC MEDIUM POWER AMPLIFIER, 12 - 30 GHz

Typical Applications

The HMC383LC4 is ideal for use as a driver amplifier for:

- Point-to-Point Radios
- Point-to-Multi-Point Radios & VSAT
- Test Equipment & Sensors
- LO Driver for HMC Mixers
- Military & Space

Functional Diagram

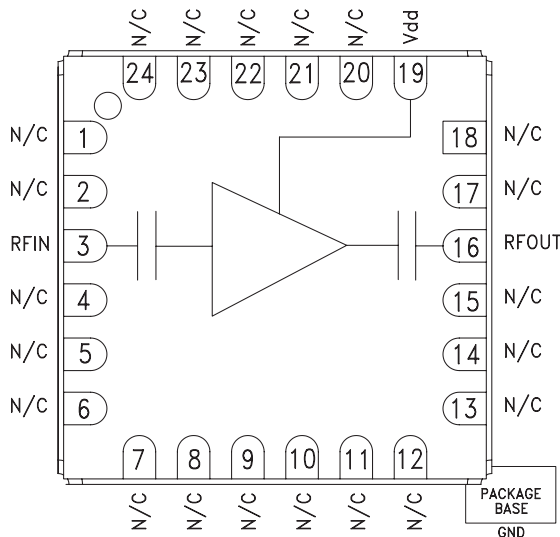

Features

- Gain: 15 dB
- Saturated Output Power: +18 dBm
- Output IP3: +25 dBm
- Single Positive Supply: +5.0 V @ 100 mA
- 50 Ohm Matched Input/Output
- RoHS Compliant 4x4 mm Package

General Description

The HMC383LC4 is a general purpose GaAs PHEMT MMIC Driver Amplifier housed in a leadless RoHS compliant SMT package. The amplifier provides 15 dB of gain and +18 dBm of saturated power from a single +5.0V supply. Consistent gain and output power across the operating band make it possible to use a common driver/LO amplifier approach in multiple radio bands. The RF I/Os are DC blocked and matched to 50 Ohms for ease of use. The HMC383LC4 is housed in a RoHS compliant leadless 4x4 mm package allowing the use of surface mount manufacturing techniques.

Electrical Specifications, $T_A = +25^\circ \text{C}$, $V_{dd} = +5\text{V}$

Parameter	Min.	Typ.	Max.	Min.	Typ.	Max.	Min.	Typ.	Max.	Min.	Typ.	Max.	Units
Frequency Range	12 - 16			16 - 24			24 - 28			28 - 30			GHz
Gain	12	15		13	16		12	15		10	13		dB
Gain Variation Over Temperature		0.02	0.03		0.02	0.03		0.02	0.03		0.02	0.03	dB/ °C
Input Return Loss		14			14			11			13		dB
Output Return Loss		14			17			10			8		dB
Output Power for 1 dB Compression (P1dB)	12	15		13.5	16.5		13	16		12	15		dBm
Saturated Output Power (Psat)		17			18			17			16		dBm
Output Third Order Intercept (IP3)		24			25			25			23		dBm
Noise Figure		10.5			8			7.5			8		dB
Supply Current (I _{dd})		100			100			100			100		mA



**GaAs PHEMT MMIC MEDIUM
POWER AMPLIFIER, 12 - 30 GHz**

Broadband Gain & Return Loss

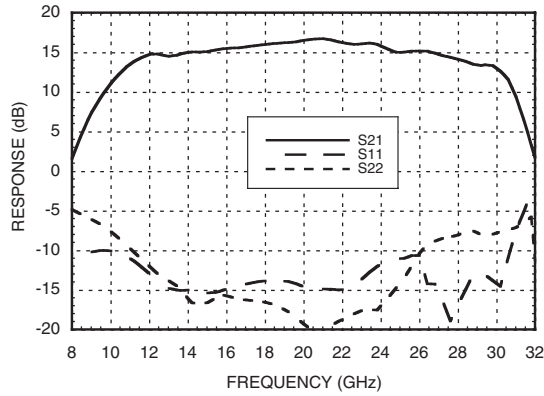

Gain vs. Temperature

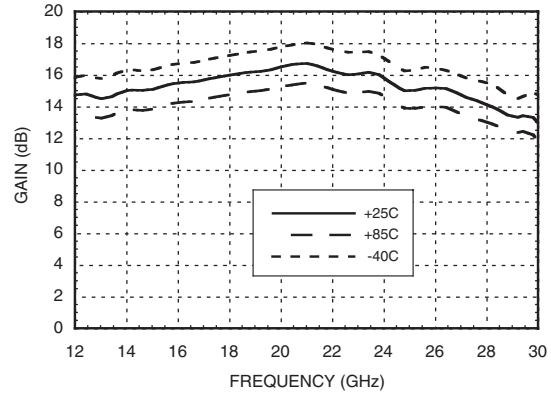

Input Return Loss vs. Temperature

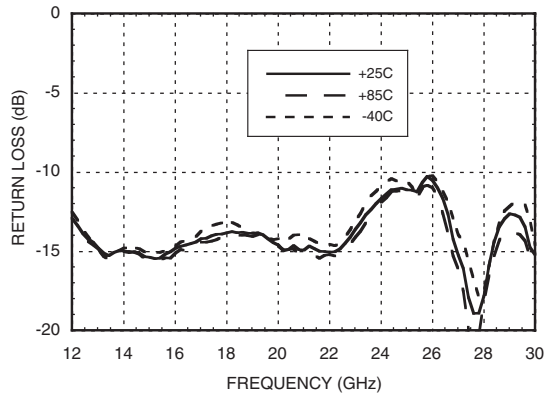

Output Return Loss vs. Temperature

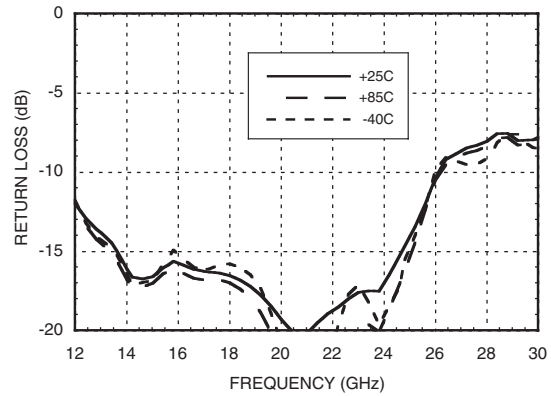

P1dB vs. Temperature

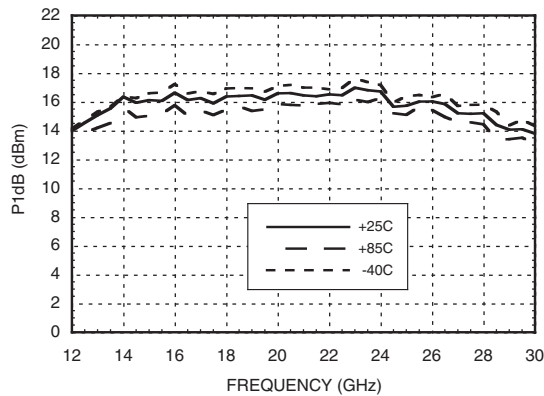

Psat vs. Temperature

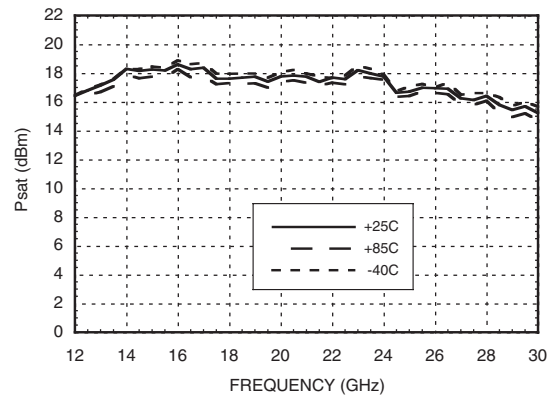

GaAs PHEMT MMIC MEDIUM POWER AMPLIFIER, 12 - 30 GHz

Power Compression @ 18 GHz

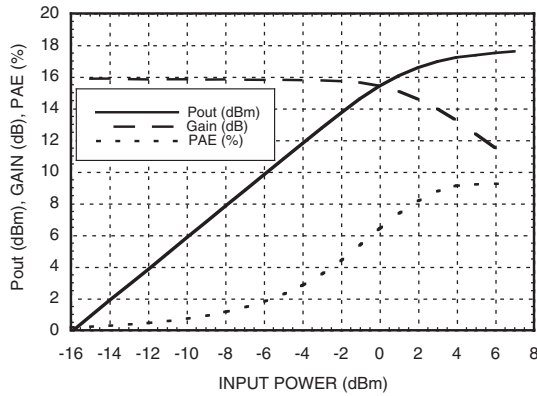

Power Compression @ 30 GHz

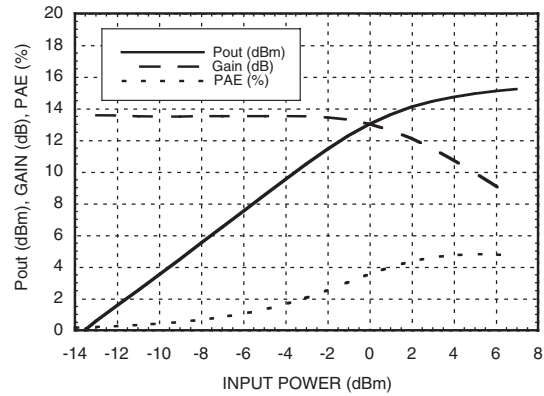

Output IP3 vs. Temperature

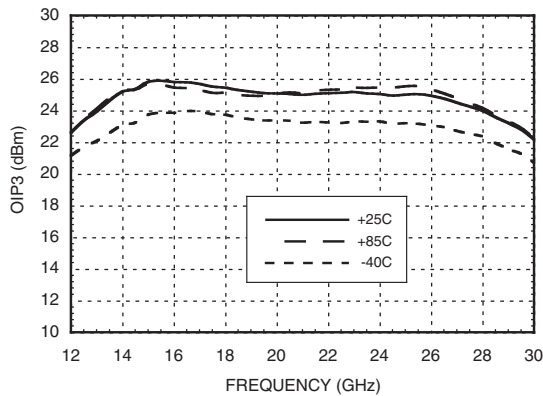

Noise Figure vs. Temperature

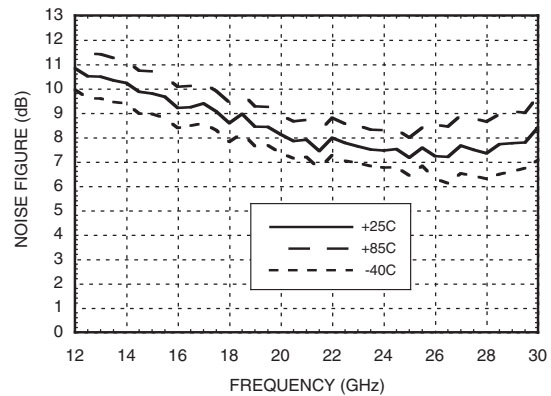

Gain & Power vs. Supply Voltage @ 18 GHz

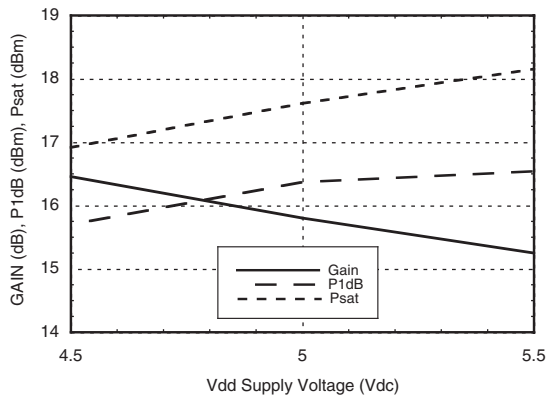

Reverse Isolation vs. Temperature

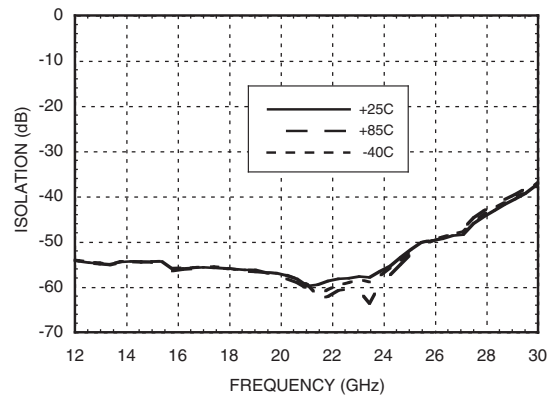

GaAs PHEMT MMIC MEDIUM POWER AMPLIFIER, 12 - 30 GHz

Absolute Maximum Ratings

Drain Bias Voltage (Vdd)	+5.5 Vdc
RF Input Power (RFIn)(Vdd = +5.0 Vdc)	+10 dBm
Channel Temperature	175 °C
Continuous Pdiss (T= 85 °C) (derate 10 mW/°C above 85 °C)	0.92 W
Thermal Resistance (channel to ground paddle)	98 °C/W
Storage Temperature	-65 to +150 °C
Operating Temperature	-40 to +85 °C
ESD Sensitivity (HBM)	Class 1A

Typical Supply Current vs. Vdd

Vdd (V)	Idd (mA)
+4.5	99
+5.0	100
+5.5	101

Note: Amplifier will operate over full voltage ranges shown above



Outline Drawing

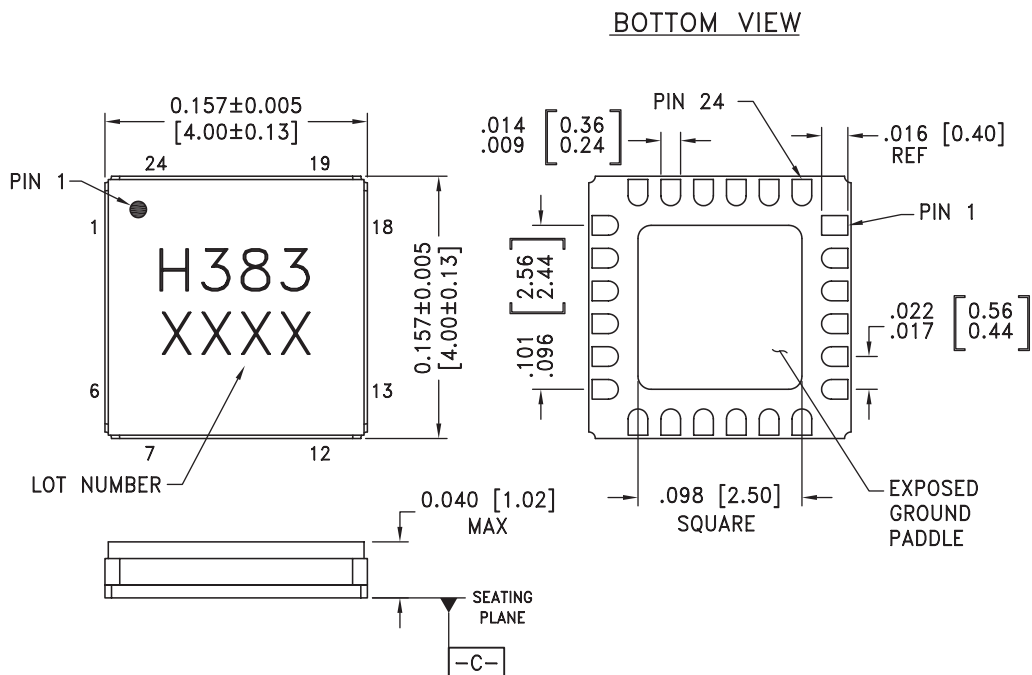

NOTES:

1. PACKAGE BODY MATERIAL: ALUMINA
2. LEAD AND GROUND PADDLE PLATING: 30-80 MICROINCHES GOLD OVER 50 MICROINCHES MINIMUM NICKEL.
3. ALL DIMENSIONS ARE IN INCHES [MM]
4. LEAD SPACING TOLERANCE IS NON-CUMULATIVE
5. PACKAGE WARP SHALL NOT EXCEED 0.05mm DATUM -C-
6. ALL GROUND LEADS AND GROUND PADDLE MUST BE SOLDERED TO PCB RF GROUND

Pin Descriptions

Pin Number	Function	Description	Interface Schematic
1, 2, 4-15, 17, 18, 20-24	N/C	No connection required. These pins may be connected to RF/DC ground without affecting performance	
3	RFIN	This pad is AC coupled and matched to 50 Ohms from 12 - 30 GHz.	RFIN — —
16	RFOUT	This pad is AC coupled and matched to 50 Ohms from 12 - 30 GHz.	— — RFOUT
19	Vdd	Power Supply Voltage for the amplifier. External bypass capacitors of 100 pF, 1,000 pF and 2.2 μF are required.	
	GND	Package base has an exposed metal ground that must be connected to RF/DC ground. Vias under the device are required	

Application Circuit

Component	Value
C1	100 pF
C2	1,000 pF
C3	2.2 μF

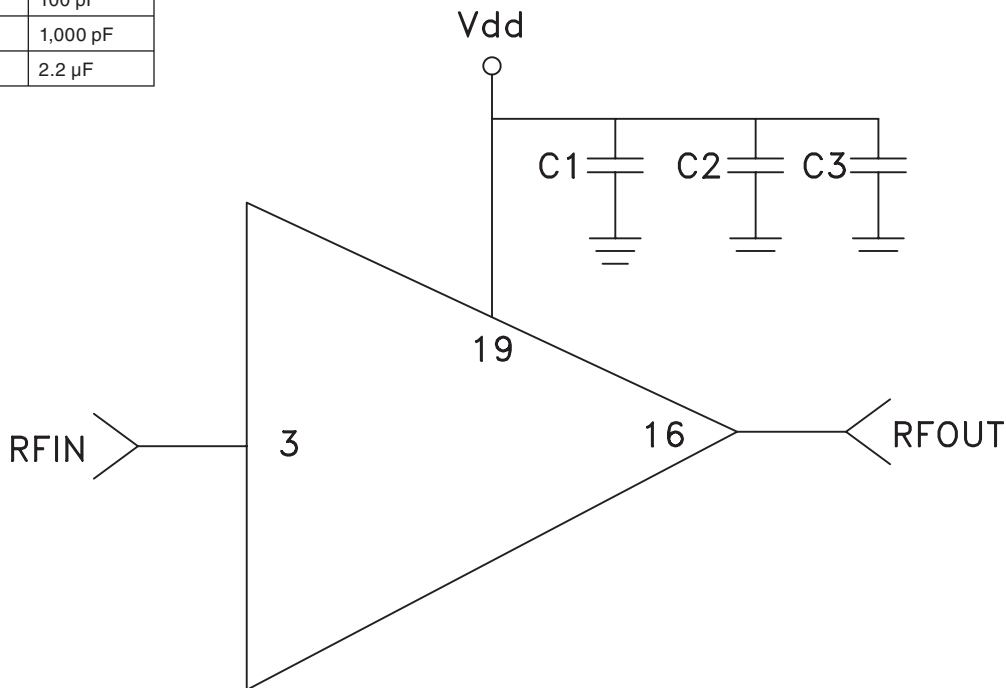

Evaluation PCB

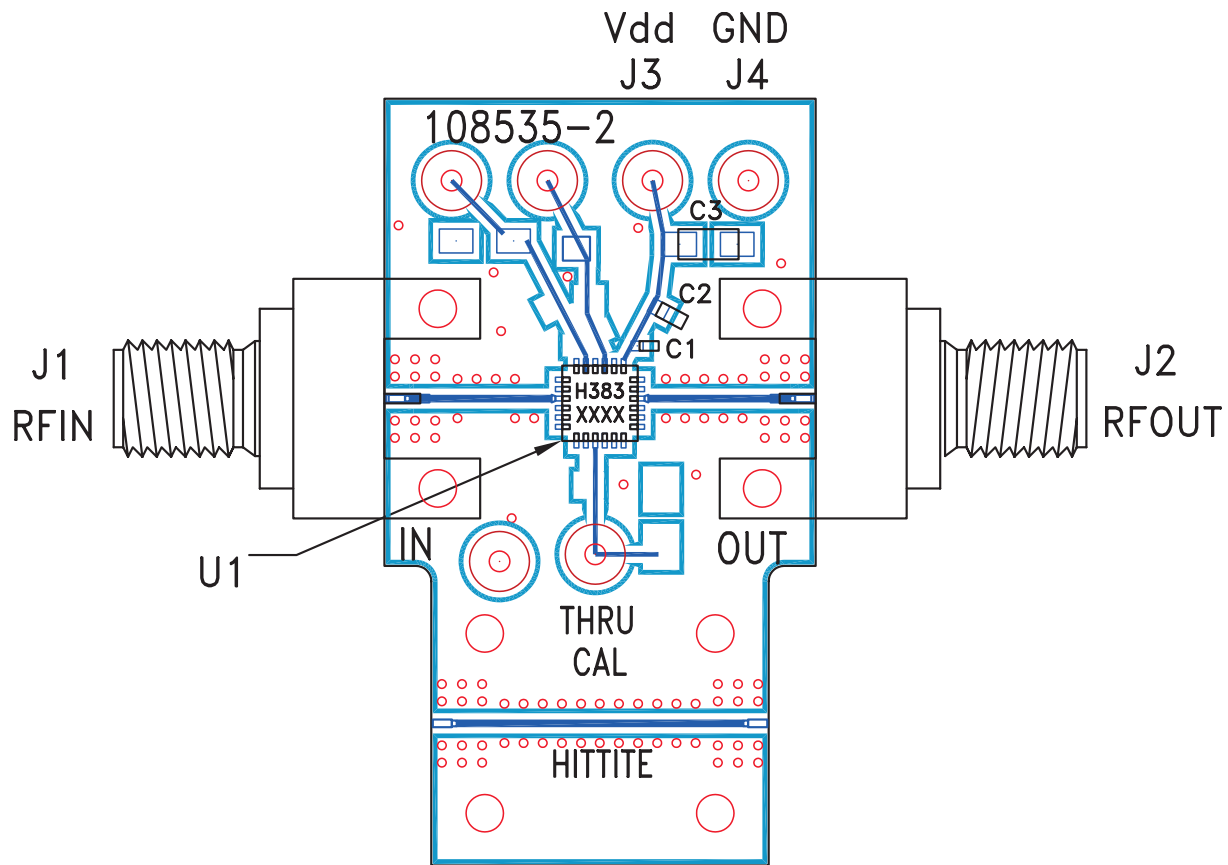

List of Materials for Evaluation PCB 108537 [1]

Item	Description
J1, J2	2.92 mm PCB mount K-connector
J3, J4	DC Pin
C1	100 pF capacitor, 0402 pkg.
C2	1,000 pF Capacitor, 0603 pkg.
C3	2.2µF Capacitor, Tantalum
U1	HMC383LC4 Amplifier
PCB [2]	108535 Evaluation PCB

[1] Refernce this number when ordering complete evaluation PCB

[2] Circuit Board Material: Rogers 4350.

The circuit board used in this application should use RF circuit design techniques. Signal lines should have 50 ohm impedance while the package ground leads and exposed paddle should be connected directly to the ground plane similar to that shown. A sufficient number of VIA holes should be used to connect the top and bottom ground planes. The evaluation board should be mounted to an appropriate heat sink. The evaluation circuit board shown is available from Hittite upon request.