

M57719

145-175MHz, 12.5V, 14W, FM MOBILE RADIO

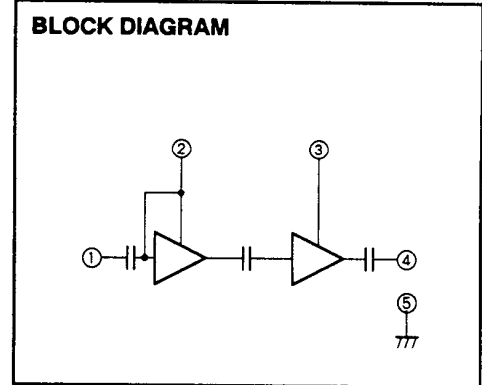
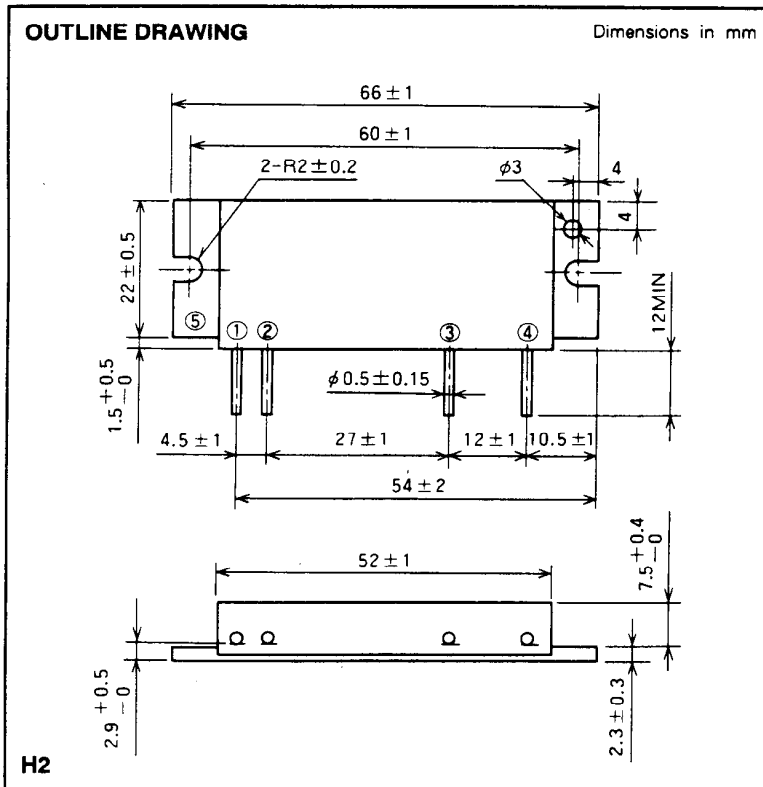

- PIN :
- ① Pin : RF INPUT
 - ② Vcc1 : 1st. DC SUPPLY
 - ③ Vcc2 : 2nd. DC SUPPLY
 - ④ Po : RF OUTPUT
 - ⑤ GND : FIN

ABSOLUTE MAXIMUM RATINGS (Tc = 25 °C unless otherwise noted)

Symbol	Parameter	Conditions	Ratings	Unit
Vcc	Supply voltage		17	V
Icc	Total current		6	A
Pin(max)	Input power	Z _G = Z _L = 50 Ω	0.4	W
Po(max)	Output power	Z _G = Z _L = 50 Ω	20	W
Tc(OP)	Operation case temperature		- 30 to 110	°C
Tstg	Storage temperature		- 40 to 110	°C

Note. Above parameters are guaranteed independently.

ELECTRICAL CHARACTERISTICS (Tc = 25 °C unless otherwise noted)

Symbol	Parameter	Test conditions	Limits		Unit
			Min	Max	
f	Frequency range	P _{in} = 0.2W Vcc = 12.5V Z _G = Z _L = 50 Ω	145	175	MHz
Po	Output power		14		W
η _T	Total efficiency		40		%
2fo	2nd. harmonic			- 25	dBc
3fo	3rd. harmonic			- 35	dBc
ρ _{in}	Input VSWR			4	-
-	Load VSWR tolerance	Vcc = 15.2V, Po = 14W (P _{in} : controlled) Load VSWR=20:1 (All phase), 2sec. Z _G = 50Ω	No degradation or destroy		-

Note. Above parameters, ratings, limits and conditions are subject to change.

TYPICAL PERFORMANCE DATA

OUTPUT POWER, TOTAL EFFICIENCY, INPUT VSWR VS. FREQUENCY

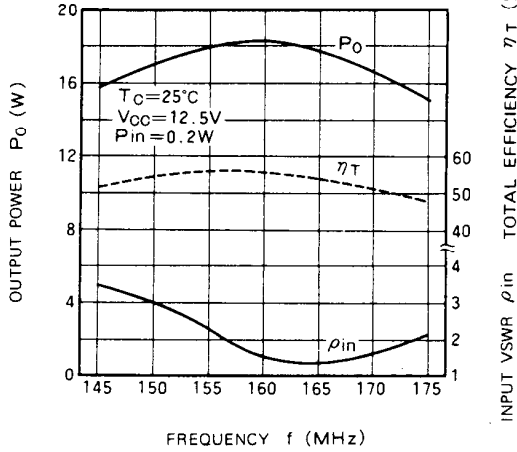

OUTPUT POWER, TOTAL EFFICIENCY, VS. INPUT POWER

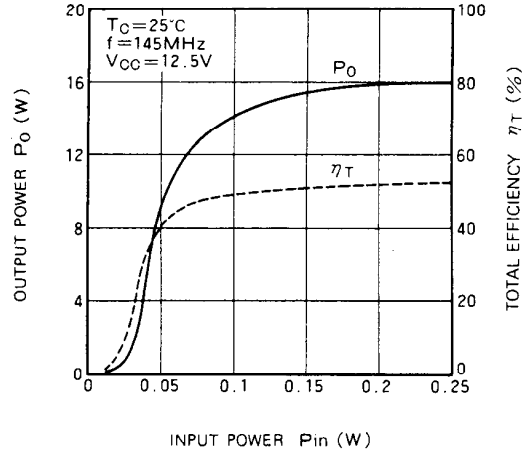

OUTPUT POWER, TOTAL EFFICIENCY, VS. INPUT POWER

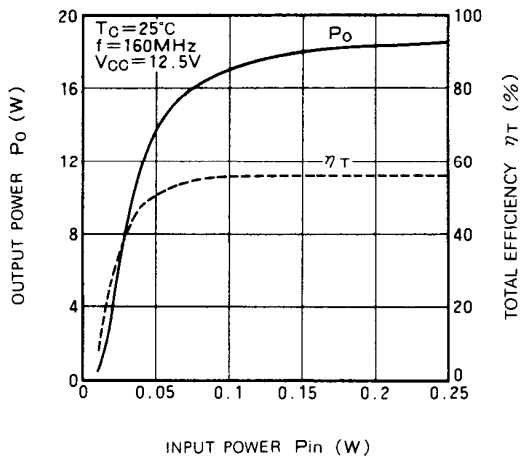

OUTPUT POWER, TOTAL EFFICIENCY, VS. INPUT POWER

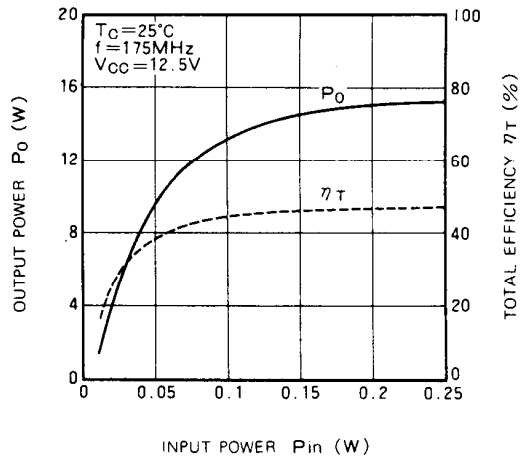

OUTPUT POWER VS. DC SUPPLY VOLTAGE

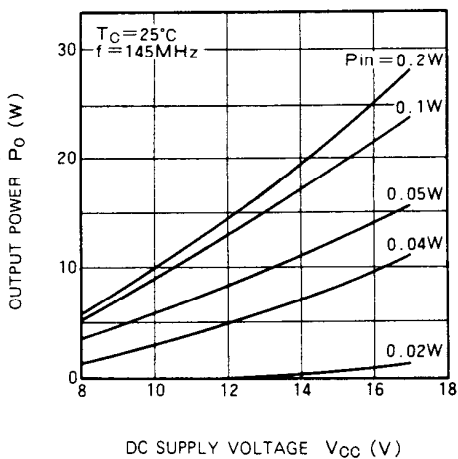

OUTPUT POWER VS. DC SUPPLY VOLTAGE

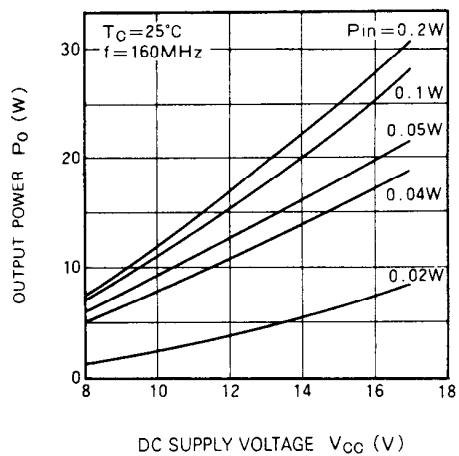

OUTPUT POWER VS. DC SUPPLY VOLTAGE

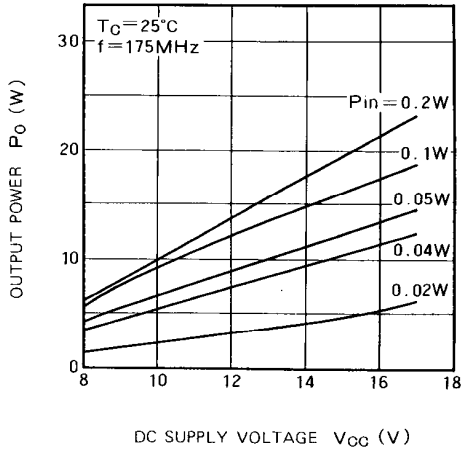

OUTPUT POWER VS. 1st VOLTAGE

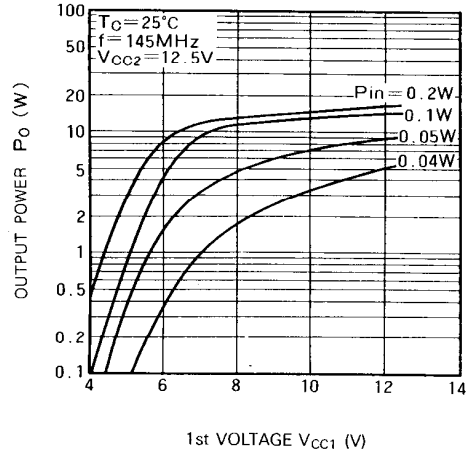

OUTPUT POWER VS. 1st VOLTAGE

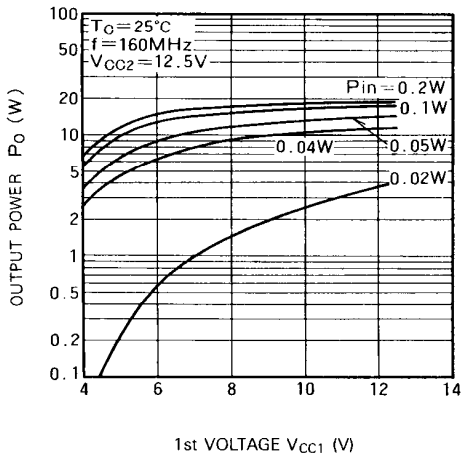

OUTPUT POWER VS. 1st VOLTAGE

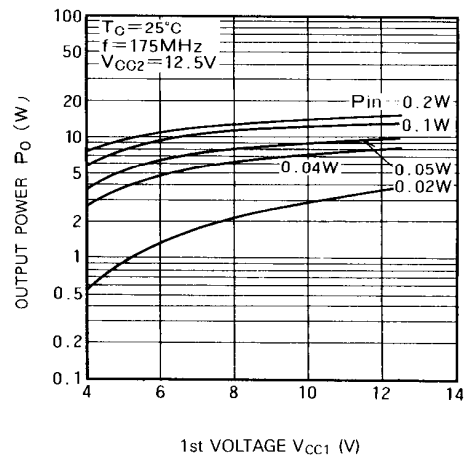

OUTPUT IMPEDANCE, INPUT IMPEDANCE VS. FREQUENCY

