

SOFT RECOVERY/FAST SWITCHING RECTIFIER

VOLTAGE RANGE 50 to 600 Volts CURRENT 3.0 Amperes

FEATURES

- * Fast switching
- * Low leakage
- * Low forward voltage drop
- * High current capability
- * High surge capability
- * High reliability

MECHANICAL DATA

- * Case: Molded plastic
- * Epoxy: Device has UL flammability classification 94V-0
- * Lead: MIL-STD-202E method 208C guaranteed
- * Mounting position: Any
- * Weight: 1.20 grams

MAXIMUM RATINGS AND ELECTRICAL CHARACTERISTICS

Ratings at 25 °C ambient temperature unless otherwise specified.
 Single phase, half wave, 60 Hz, resistive or inductive load.
 For capacitive load, derate current by 20%.

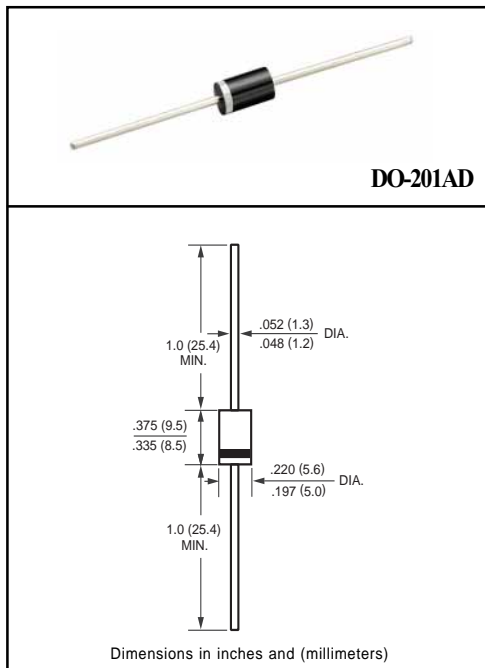

MAXIMUM RATINGS (At TA = 25°C unless otherwise noted)

RATINGS	SYMBOL	RL850	RL851	RL852	RL854	RL856	UNITS
Maximum Recurrent Peak Reverse Voltage	V _{RRM}	50	100	200	400	600	Volts
Maximum RMS Voltage	V _{RMS}	35	70	140	280	420	Volts
Maximum DC Blocking Voltage	V _{BC}	50	100	200	400	600	Volts
Maximum Average Forward Rectified Current at TA = 90°C	I _O	3.0					Amps
Peak Forward Surge Current 8.3 ms single half sine-wave superimposed on rated load (JEDEC method)	I _{FSM}	100					Amps
Maximum Reverse Recovery Current	I _{RR}	2.0					Amps
Typical Junction Capacitance (Note 2)	C _J	65					pF
Operating and Storage Temperature Range	T _J , T _{STG}	-65 to + 150					°C

ELECTRICAL CHARACTERISTICS (At TA = 25°C unless otherwise noted)

CHARACTERISTICS	SYMBOL	RL850	RL851	RL852	RL854	RL856	UNITS
Maximum Instantaneous Forward Voltage at 3.0A DC	V _F	1.3					Volts
Maximum DC Reverse Current at Rated DC Blocking Voltage TA = 25°C	I _R	1.0					uAmps
Maximum Full Load Reverse Current Average , Full Cycle .375" (9.5mm) lead length at TL = 100°C		150	150	200	250	300	uAmps
Maximum Reverse Recovery Time (Note 1)	t _{rr}	200					nSec

NOTES : 1. Test Conditions: I_F = 1.0A, V_R = 30V

2. Measured at 1 MHz and applied reverse voltage of 4.0 volts

RATING AND CHARACTERISTIC CURVES (RL850 THRU RL856)

