

# SONY CXK5816PN/M

10/10L/12/  
12L/15/15L

## 2048-word × 8 bit High Speed CMOS Static RAM

### Description

CXK5816PN/M is a 16,384 bits high speed CMOS static RAM organized as 2,048 words by 8 bits and operates from a single 5V supply. This device is suitable for use in high speed and low power applications in which battery back up for nonvolatility is required.

### Features

- High speed operation (Access time)  
CXK5816PN/M -10, 10L 100ns (Max.)  
CXK5816PN/M -12, 12L 120ns (Max.)  
CXK5816PN/M -15, 15L 150ns (Max.)
- Low power consumption (Standby) (Operation)  
CXK5816PN/M -10, 12, 15 100 $\mu$ W(Typ.) 125mW(Typ.)  
CXK5816PN/M -10L, 12L, 15L 5 $\mu$ W(Typ.) 125mW(Typ.)
- Single +5V supply: 5V $\pm$ 10%.
- Fully static memory . . . . . No clock or timing strobe required
- Equal access and cycle time
- Common data input and output: three-state output
- Directly TTL compatible: All inputs and outputs
- Low voltage data retention: 2.0V (Min.)

### Function

2048-word × 8 bit static RAM

### Structure

Silicon gate CMOS IC

### Block Diagram

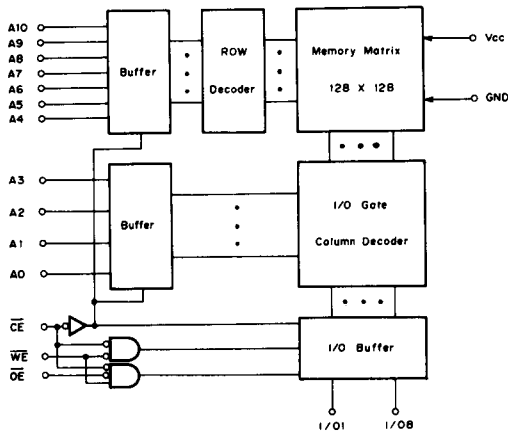

**Note)** All Typical values are measured under the conditions  
V<sub>CC</sub>=5.0V and T<sub>a</sub>=25°C.

### Package Outline

Unit: mm

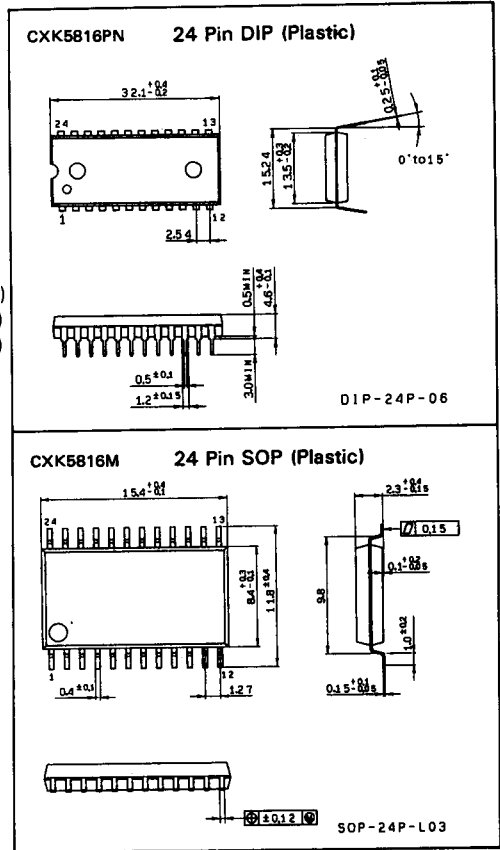

Pin Configuration (Top View)

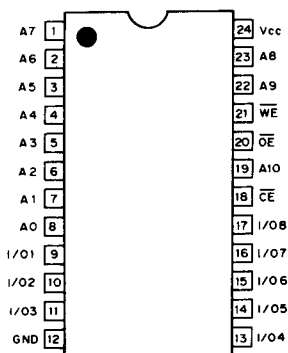

Pin Description

Symbol	Description
A0 to A10	Address input
I/O1 to I/O8	Data input output
$\overline{CE}$	Chip enable input
$\overline{WE}$	Write enable input
$\overline{OE}$	Output enable input
Vcc	+5V power supply
GND	Ground

Absolute Maximum Ratings

Ta = 25°C, GND = 0V

Item	Symbol	Rating	Unit
Supply voltage	V <sub>CC</sub>	-0.5* to +7.0	V
Input voltage	V <sub>IN</sub>	-0.5* to V <sub>CC</sub> +0.5	V
Input and output voltage	V <sub>I/O</sub>	-0.5* to V <sub>CC</sub> +0.5	V
Allowable power dissipation	P <sub>D</sub>	CXK5816PN/SP	1.0
		CXK5816M	0.7
Operating temperature	T <sub>opr</sub>	0 to +70	°C
Storage temperature	T <sub>stg</sub>	-55 to +150	°C
Soldering temperature	T <sub>solder</sub>	260*10	°C • sec

\* V<sub>CC</sub>, V<sub>IN</sub>, V<sub>I/O</sub> Minimum value = -3.0V, Pulse width is under 50 ns.

Truth Table

$\overline{CE}$	$\overline{OE}$	$\overline{WE}$	Mode	I/O1 to I/O8	V <sub>CC</sub> Current
H	X	X	Not selected	High Z	I <sub>SB1</sub> , I <sub>SB2</sub>
L	H	H	Output disable	High Z	I <sub>CC1</sub> , I <sub>CC2</sub>
L	L	H	Read	D out	I <sub>CC1</sub> , I <sub>CC2</sub>
L	X	L	Write	D in	I <sub>CC1</sub> , I <sub>CC2</sub>

Note) X: "H" or "L"

DC Recommended Operating Conditions

Ta = 0 to +70°C, GND = 0V

Item	Symbol	Min.	Typ.	Max.	Unit
Supply voltage	V <sub>CC</sub>	4.5	5.0	5.5	V
Input high voltage	V <sub>IH</sub>	2.2	—	V <sub>CC</sub> +0.3	V
Input low voltage	V <sub>IL</sub>	-0.3	—	0.8	V

## DC and Operating Characteristics

 $V_{CC}=5V \pm 10\%$ ,  $GND=0V$ ,  $T_a=0$  to  $+70^\circ C$ 

Item	Symbol	Test condition	CXK5816PN/M/SP -10/12/15			CXK5816PN/M/SP -10L/12L/15L			Unit
			Min.	Typ.**	Max.	Min.	Typ.**	Max.	
Input leakage current	$I_{LI}$	$V_{IN}=GND$ to $V_{CC}$	-2	—	2	-2	—	2	$\mu A$
Output leakage current	$I_{LO}$	$\overline{CE}=V_{IH}$ or $\overline{OE}=V_{IH}$ $V_{I/O}=GND$ to $V_{CC}$	-2	—	2	-2	—	2	$\mu A$
Operating power supply current	$I_{CC1}$	$\overline{CE}=V_{IL}$ , $I_{OUT}=0mA$	—	25	60	—	25	60	mA
Average operating current	$I_{CC2}$	Cycle = Min, Duty = 100% $I_{OUT}=0mA$	—	28 *(31)	60 *(75)	—	28 *(31)	60 *(75)	mA
Standby current	$I_{SB1}$	$\overline{CE} \geq V_{CC} - 0.2V$	—	0.02	1.0	—	0.001	0.05	mA
	$I_{SB2}$	$\overline{CE}=V_{IH}$	—	0.3	2	—	0.2	1	mA
Output high voltage	$V_{OH}$	$I_{OH}=-1.0mA$	2.4	—	—	2.4	—	—	V
Output low voltage	$V_{OL}$	$I_{OL}=4.0mA$	—	—	0.4	—	—	0.4	V

\* **Note)** Shows CXK5816PN/M/SP-10, 10L value.\*\*  $V_{CC}=5V$ ,  $T_a=25^\circ C$ 

## Capacitance

 $T_a=25^\circ C$ ,  $f=1$  MHz

Item	Test condition	Symbol	Min.	Max.	Unit
Input capacitance	$V_{IN}=0V$	$C_{IN}$	—	7	pF
Input/output capacitance	$V_{I/O}=0V$	$C_{I/O}$	—	10	pF

**Note)** This parameter is sampled and is not 100% tested.

## AC Operating Characteristics

## • AC test condition

 $V_{CC} = 5V \pm 10\%$ ,  $T_a = 0$  to  $+70^\circ C$ 

Item	Condition
Input pulse high level	$V_{IH} = 2.4V$
Input pulse low level	$V_{IL} = 0.6V$
Input rise time	$t_R = 5ns$
Input fall time	$t_F = 5ns$
Input and output timing reference level	1.5V
Output load	$C_L^* = 100pF, 1TTL$

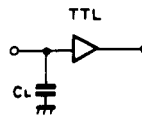
\*  $C_L$  includes scope and jig capacitance.

## • Read cycle

Item	Symbol	CXK5816PN/M -10/10L		CXK5816PN/M -12/12L		CXK5816PN/M -15/15L		Unit
		Min.	Max.	Min.	Max.	Min.	Max.	
		Read cycle time	$t_{RC}$	100	—	120	—	
Address access time	$t_{AA}$	—	100	—	120	—	150	ns
Chip enable access time	$t_{CO}$	—	100	—	120	—	150	ns
Output enable to output valid	$t_{OE}$	—	50	—	55	—	60	ns
Output hold from address change	$t_{OH}$	15	—	15	—	15	—	ns
Chip enable to output in low Z (CE)	$t_{LZ}$	15	—	15	—	15	—	ns
Output enable to output in low Z (OE)	$t_{OLZ}$	10	—	10	—	10	—	ns
Chip disable to output in high Z (CE)	* $t_{HZ}$	0	30	0	40	0	50	ns
Output disable to output in high Z (OE)	* $t_{OHZ}$	0	30	0	40	0	50	ns

\* **Note**  $t_{HZ}$  and  $t_{OHZ}$  are specified by the time length until the output circuit is turned off and not specified by the output voltage level.

## • Write cycle

Item	Symbol	CXK5816PN/M -10/10L		CXK5816PN/M -12/12L		CXK5816PN/M -15/15L		Unit
		Min.	Max.	Min.	Max.	Min.	Max.	
		Write cycle time	$t_{WC}$	100	—	120	—	
Address valid to end of write	$t_{AW}$	80	—	100	—	120	—	ns
Chip enable to end of write	$t_{CW}$	80	—	100	—	120	—	ns
Data to write time overlap	$t_{DW}$	30	—	35	—	40	—	ns
Data hold from write time	$t_{DH}$	0	—	0	—	0	—	ns
Write pulse width	$t_{WP}$	60	—	75	—	90	—	ns
Address setup time	$t_{AS}$	0	—	0	—	0	—	ns
Write recovery time	$t_{WR}$	5	—	5	—	5	—	ns
Output active from end of write	$t_{OW}$	15	—	15	—	15	—	ns
Write to output in high Z	$t_{WHZ}$ *	0	30	0	40	0	50	ns

\* **Note**  $t_{WHZ}$  is specified by the time length until the output circuit is turned off and not specified by the output voltage level.

Timing Waveform

(1) Read Cycle [ $\overline{WE}=V_{IH}$ ]

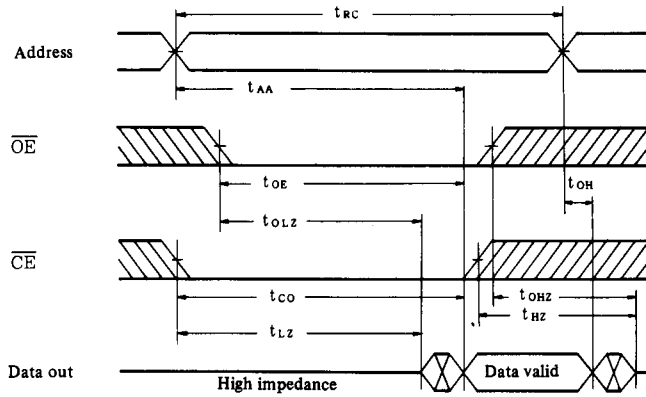

(2) Write Cycle (1):  $\overline{WE}$  Control [ $\overline{OE}=V_{IH}$ ]

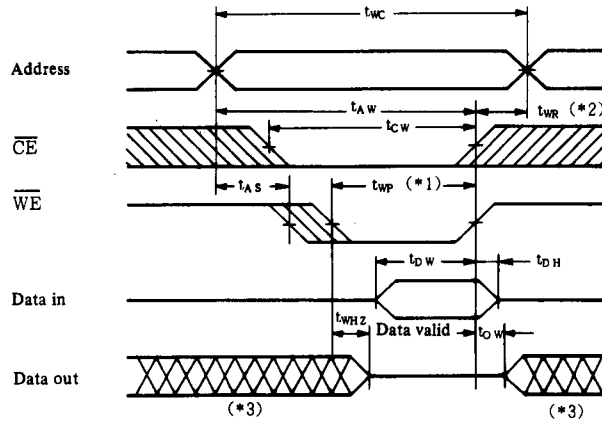

Write Cycle (2):  $\overline{CE}$  Control [ $\overline{OE}=V_{IL}$ ]

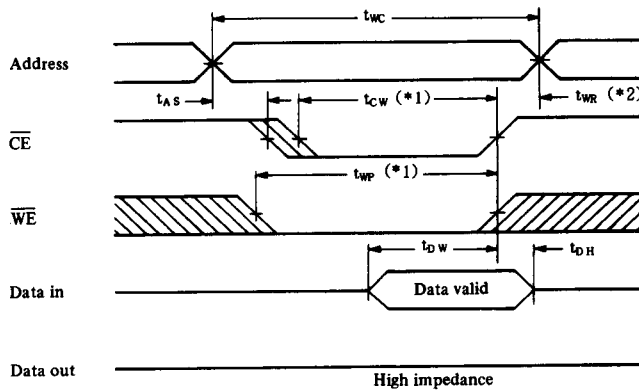

Note)

- \*1 A write occurs during the low overlap of  $\overline{CE}$  and  $\overline{WE}$ .
- \*2  $t_{WR}$  is measured from the earlier of  $\overline{CE}$  or  $\overline{WE}$  going high to the end of write cycle.
- \*3 During this period, I/O pins are in the output state so that the input signals of opposite phase to the outputs must not be applied.

Data Retention Characteristics

Ta = 0 to +70°C

Item	Symbol	Test condition	CXK5816PN/M -10/12/15			CXK5816PN/M -10L/12L/15L			Unit
			Min.	Typ.	Max.	Min.	Typ.	Max.	
Data retention voltage	$V_{DR}$	$\overline{CE} \geq V_{CC} - 0.2V$	2.0	5.0	5.5	2.0	5.0	5.5	V
Data retention current	$I_{CCDR1}$	$V_{CC} = 3.0V, \overline{CE} \geq 2.8V$	—	12	600	—	0.6	30	$\mu A$
	$I_{CCDR2}$	$V_{CC} = 2.0 \text{ to } 5.5V, \overline{CE} \geq V_{CC} - 0.2V$	—	20	1000	—	1.0	50	$\mu A$
Data retention set up time	$t_{CDRS}$	Chip disable to data retention mode	0	—	—	0	—	—	ns
Recovery time	$t_R$		$t_{RC}^*$	—	—	$t_{RC}^*$	—	—	ns

\*  $t_{RC}$  : Read cycle time

Data Retention Waveform

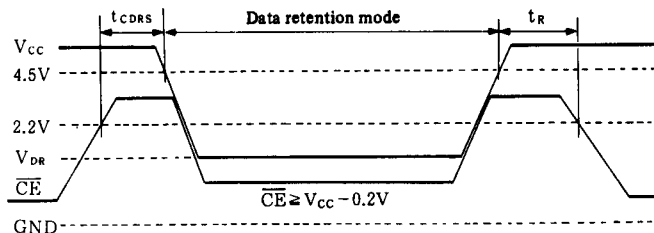

Supply current vs. Supply voltage

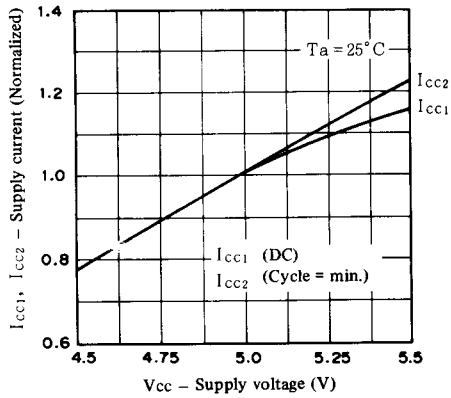

Supply current vs. Ambient temperature

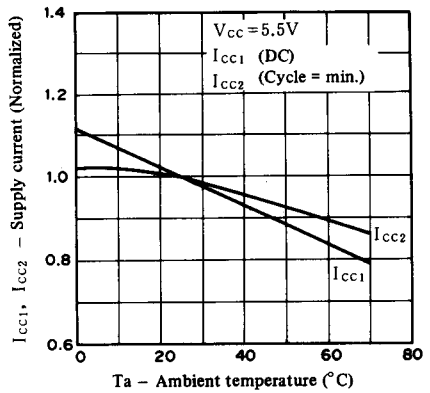

Supply current vs. Frequency

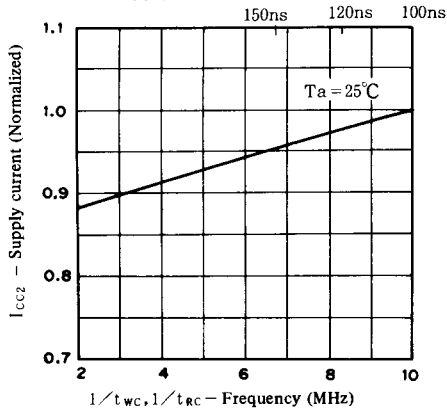

Access time vs. Load capacitance

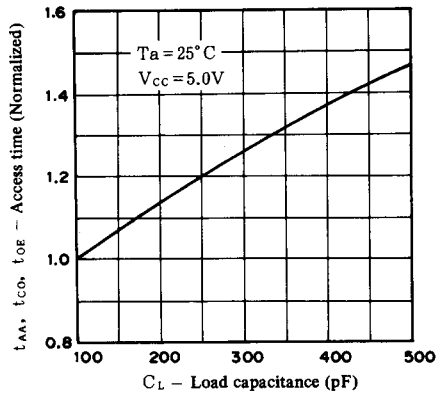

Access time vs. Supply voltage

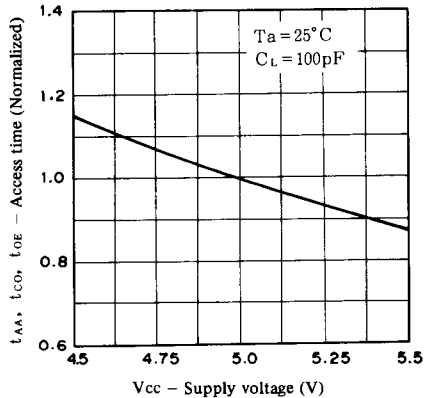

Access time vs. Ambient temperature

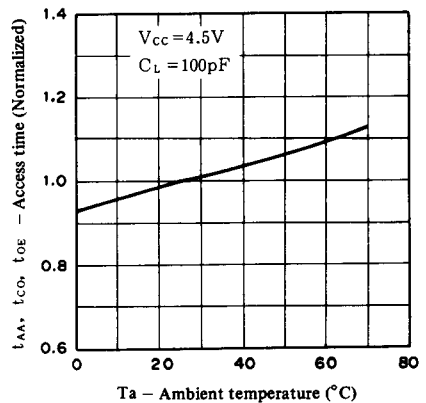

Standby current (1) vs. Supply voltage

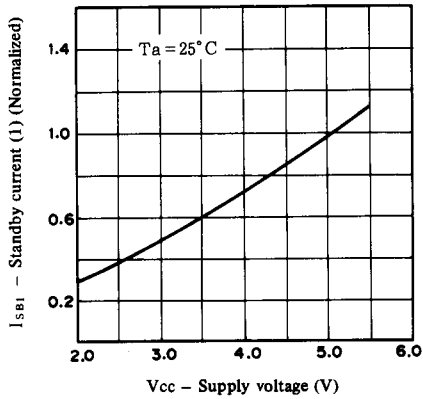

Standby current (1) vs. Ambient temperature

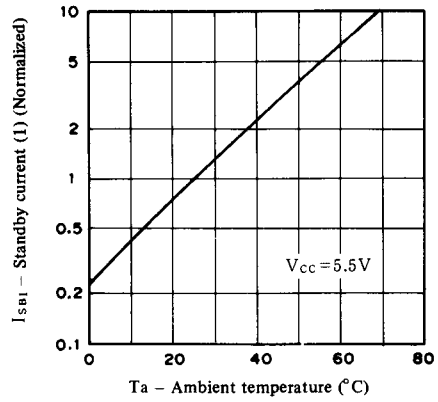

Standby current (2) vs. Supply voltage

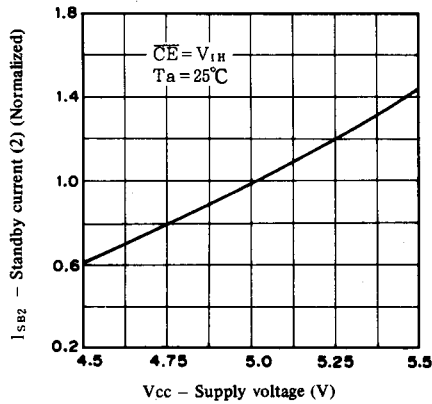

Standby current (2) vs. Ambient temperature

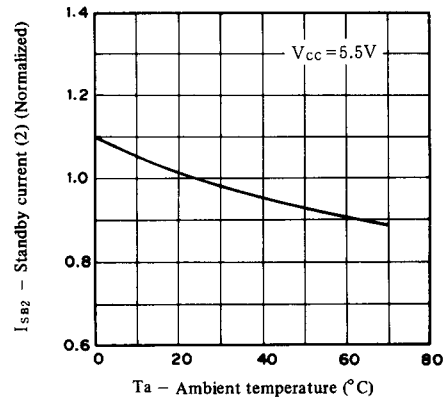

Output high current vs. Output high voltage  
Output low current vs. Output low voltage

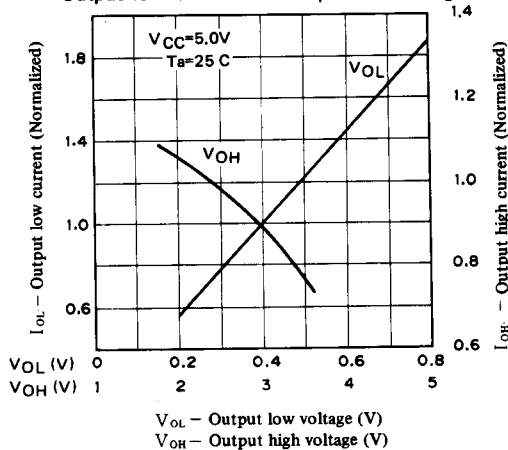



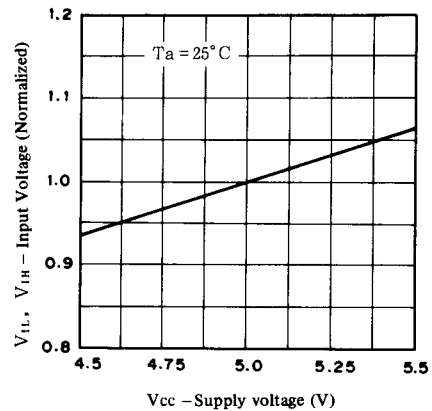











Input voltage vs. Supply voltage





T-90-20

### 7. Sony Package Product Name

Type	Package name		Package	Features				
	Symbol	Description		Material*	Lead pitch	Lead shape	Lead pull out direction	
Inserted	Standard	DIP	DUAL IN LINE PACKAGE		P C	2.54mm (100MIL)	Through Hole Lead	2-direction
		SIP	SINGLE IN LINE PACKAGE		P	2.54mm (100MIL)	Through Hole Lead	1-direction
		ZIP	ZIG ZAG IN LINE PACKAGE		P	2.54mm (100MIL) Zig Zag inline	Through Hole Lead	1-direction
		PGA	PIN GRID ARRAY		C	2.54mm (100MIL)	Through Hole Lead	4-direction
		PIGGY BACK	PIGGY BACK		C	2.54mm (100MIL)	Through Hole Lead	2-direction
Shrink	SDIP	SHRINK DUAL IN LINE PACKAGE		P	1.778mm (70MIL)	Through Hole Lead	2-direction	
Surface mounted	Standard flat package	QFP	QUAD FLAT PACKAGE		P	1.0mm 0.8mm	Gull-Wing	4-direction
		SOP	SMALL OUTLINE PACKAGE		P	1.27mm (50MIL)	Gull-Wing	2-direction
	Shrink flat package	VQFP	VERY SMALL QUAD FLAT PACKAGE		P	0.5mm	Gull-Wing	4-direction
		VSOP	VERY SMALL OUTLINE PACKAGE		P	0.65mm	Gull-Wing	2-direction
	Standard chip carrier	PLCC	PLASTIC LEADED CHIP CARRIER		P	1.27mm (50MIL)	J-bend	4-direction
		LCC	LEAD LESS CHIP CARRIER		C	1.27mm (50MIL)	Lead less	Package side
	Shrink chip carrier	SPLCC (PLCC)	SHRINK PLASTIC LEADED CHIP CARRIER		P	1.27mm Max. (50MIL Max.)	J-bend	4-direction
	Standard 2-direction chip carrier	SOJ	SMALL OUTLINE J-LEAD PACKAGE		P	1.27mm (50MIL)	J-bend	2-direction

\*P.....Plastic, C.....Ceramic