

**ADSP-BF535**
**KEY FEATURES**

**350 MHz High Performance Blackfin Processor Core**  
**Two 16-Bit MACs, Two 40-Bit ALUs, One 40-Bit Shifter,**  
**Four 8-Bit Video ALUs, and Two 40-Bit Accumulators**  
**RISC-Like Register and Instruction Model for Ease of**  
**Programming and Compiler Friendly Support**  
**Advanced Debug, Trace, and Performance Monitoring**  
**1.0 V–1.6 V Core V<sub>DD</sub> with Dynamic Power Management**  
**3.3 V I/O**  
**260-Ball PBGA Package**

**MEMORY**

**308K Bytes of On-Chip Memory:**  
**16K Bytes of Instruction L1 SRAM/Cache**  
**32K Bytes of Data L1 SRAM/Cache**  
**4K Bytes of Scratch Pad L1 SRAM**  
**256K Bytes of Full Speed, Low Latency L2 SRAM**  
**Memory DMA Controller**

**Memory Management Unit for Memory Protection**  
**Glueless External Memory Controllers**  
**Synchronous SDRAM Support**  
**Asynchronous with SRAM, Flash, ROM Support**

**PERIPHERALS**

**32-Bit, 33 MHz, 3.3 V, PCI 2.2 Compliant Bus Interface**  
**with Master and Slave Support**  
**Integrated USB 1.1 Compliant Device Interface**  
**Two UARTs, One with IrDA®**  
**Two SPI Compatible Ports**  
**Two Full-Duplex Synchronous Serial Ports (SPORTs)**  
**Four Timer/Counters, Three with PWM Support**  
**Sixteen Bidirectional Programmable Flag I/O Pins**  
**Watchdog Timer**  
**Real-Time Clock**  
**On-Chip PLL with 1× to 31× Frequency Multiplier**

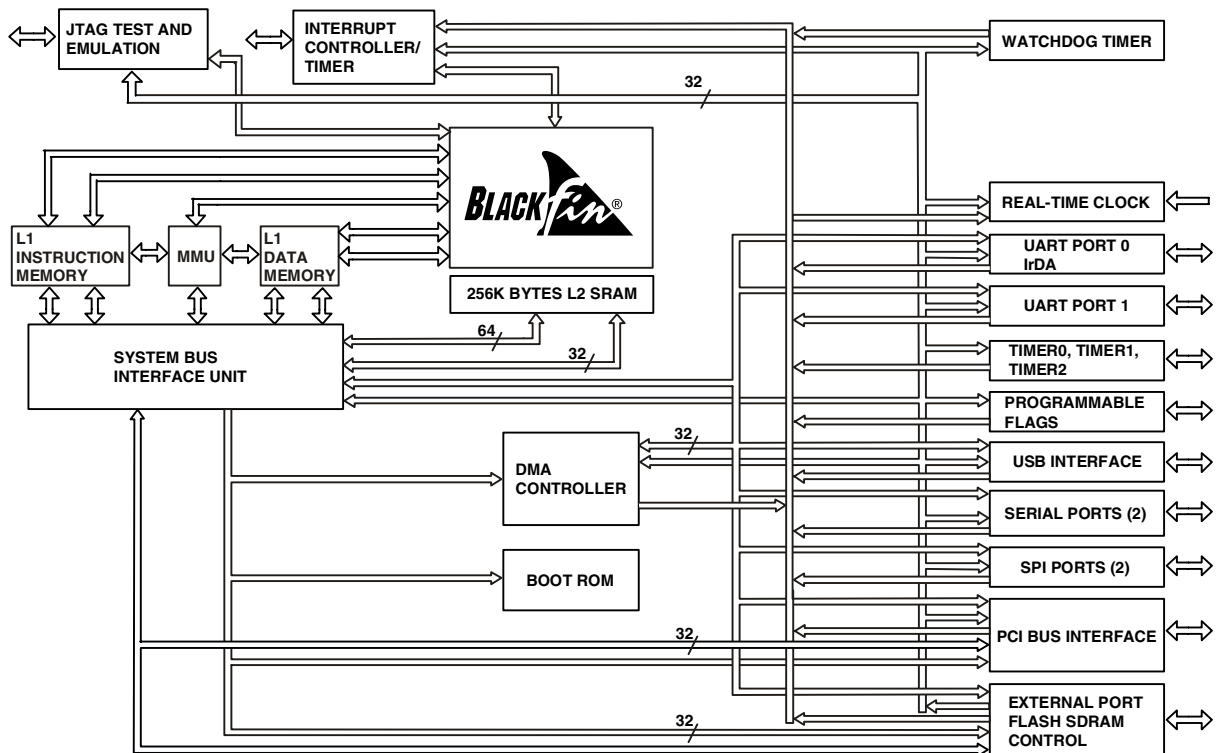
**FUNCTIONAL BLOCK DIAGRAM**

Blackfin and the Blackfin logo are registered trademarks of Analog Devices, Inc.

REV. A

Information furnished by Analog Devices is believed to be accurate and reliable. However, no responsibility is assumed by Analog Devices for its use, nor for any infringements of patents or other rights of third parties that may result from its use. No license is granted by implication or otherwise under any patent or patent rights of Analog Devices. Trademarks and registered trademarks are the property of their respective owners.

# ADSP-BF535

## TABLE OF CONTENTS

GENERAL DESCRIPTION	2
Portable Low Power Architecture	2
System Integration	2
ADSP-BF535 Peripherals	3
Processor Core	3
Memory Architecture	4
Internal (On-Chip) Memory	5
External (Off-Chip) Memory	5
PCI	5
I/O Memory Space	5
Booting	6
Event Handling	6
Core Event Controller (CEC)	6
System Interrupt Controller (SIC)	6
Event Control	7
DMA Controllers	7
External Memory Control	8
PC133 SDRAM Controller	8
Asynchronous Controller	8
PCI Interface	8
PCI Host Function	8
PCI Target Function	8
USB Device	8
Real-Time Clock	9
Watchdog Timer	9
Timers	9
Serial Ports (Sports)	9
Serial Peripheral Interface (SPI) Ports	10
UART Port	10
Programmable Flags (PFX)	11
Dynamic Power Management	11
Full On Operating Mode	
– Maximum Performance	11
Active Operating Mode	
– Moderate Power Savings	11
Sleep Operating Mode	
– High Power Savings	11
Deep Sleep Operating Mode	
– Maximum Power Savings	12
Mode Transitions	12
Power Savings	12
Peripheral Power Control	13
Clock Signals	13
Booting Modes	14
Instruction Set Description	14
Development Tools	15
EZ-KITLite™ for ADSP-BF535 Blackfin Processor	16
Designing an Emulator Compatible Processor Board (Target)	16
Additional Information	16
PIN DESCRIPTIONS	17
Unused Pins	20
SPECIFICATIONS	21
ABSOLUTE MAXIMUM RATINGS	22
ESD SENSITIVITY	22
TIMING SPECIFICATIONS	23
Clock and Reset Timing	24

Programmable Flags Cycle Timing	25
Timer PWM_OUT Cycle Timing	26
Asynchronous Memory Write Cycle Timing	27
Asynchronous Memory Read Cycle Timing	28
SDRAM Interface Timing	29
Serial Ports	30
Serial Peripheral Interface (SPI) Port	
–Master Timing	32
Serial Peripheral Interface (SPI) Port	
–Slave Timing	33
Universal Asynchronous Receiver-Transmitter (UART) Port—Receive and Transmit Timing	34
JTAG Test and Emulation Port Timing	35
Output Drive Currents	36
Power Dissipation	36
Test Conditions	37
Output Enable Time	37
Output Disable Time	37
Example System Hold Time Calculation	37
Environmental Conditions	38
260-Ball PBGA Pinout	39
OUTLINE DIMENSIONS	44
ORDERING GUIDE	44

## GENERAL DESCRIPTION

The ADSP-BF535 processor is a member of the Blackfin processor family of products, incorporating the Micro Signal Architecture (MSA), jointly developed by Analog Devices, Inc. and Intel Corporation. The architecture combines a dual MAC state-of-the-art signal processing engine, the advantages of a clean, orthogonal RISC-like microprocessor instruction set, and Single-Instruction, Multiple Data (SIMD) multimedia capabilities into a single instruction set architecture.

By integrating a rich set of industry leading system peripherals and memory, Blackfin processors are the platform of choice for next generation applications that require RISC-like programmability, multimedia support, and leading edge signal processing in one integrated package.

### Portable Low Power Architecture

Blackfin processors provide world class power management and performance. Blackfin processors are designed in a low power and low voltage design methodology and feature dynamic power management, the ability to independently vary both the voltage and frequency of operation to significantly lower overall power consumption. Varying the voltage and frequency can result in a substantial reduction in power consumption, by comparison to just varying the frequency of operation. This translates into longer battery life for portable appliances.

### System Integration

The ADSP-BF535 Blackfin processor is a highly integrated system-on-a-chip solution for the next generation of digital communication and portable Internet appliances. By combining industry-standard interfaces with a high performance signal processing core, users can develop cost-effective solutions quickly without the need for costly external components. The ADSP-BF535 Blackfin processor system peripherals include UARTs, SPIs, SPORTs, general-purpose Timers, a Real-Time

Clock, Programmable Flags, Watchdog Timer, and USB and PCI buses for glueless peripheral expansion.

## ADSP-BF535 Peripherals

The ADSP-BF535 Blackfin processor contains a rich set of peripherals connected to the core via several high bandwidth buses, providing flexibility in system configuration as well as excellent overall system performance. See Functional Block Diagram on Page 1. The base peripherals include general-purpose functions such as UARTs, timers with PWM (Pulse Width Modulation) and pulse measurement capability, general-purpose flag I/O pins, a real-time clock, and a watchdog timer. This set of functions satisfies a wide variety of typical system support needs and is augmented by the system expansion capabilities of the part. In addition to these general-purpose peripherals, the ADSP-BF535 Blackfin processor contains high speed serial ports for interfaces to a variety of audio and modem CODEC functions. It also contains an event handler for flexible management of interrupts from the on-chip peripherals and external sources. And it contains power management control functions to tailor the performance and power characteristics of the processor and system to many application scenarios.

The on-chip peripherals can be easily augmented in many system designs with little or no glue logic due to the inclusion of several interfaces providing expansion on industry-standard buses. These include a 32-bit, 33 MHz, V2.2 compliant PCI bus, SPI serial expansion ports, and a device type USB port. These enable the connection of a large variety of peripheral devices to tailor the system design to specific applications with a minimum of design complexity.

All of the peripherals, except for programmable flags, real-time clock, and timers, are supported by a flexible DMA structure with individual DMA channels integrated into the peripherals. There is also a separate memory DMA channel dedicated to data transfers between the various memory spaces including external SDRAM and asynchronous memory, internal Level 1 and Level 2 SRAM, and PCI memory spaces. Multiple on-chip 32-bit buses, running at up to 133 MHz, provide adequate bandwidth to keep the processor core running along with activity on all of the on-chip and external peripherals.

## Processor Core

As shown in Figure 1, the Blackfin processor core contains two multiplier/accumulators (MACs), two 40-bit ALUs, four video ALUs, and a single shifter. The computational units process 8-bit, 16-bit, or 32-bit data from the register file.

Each MAC performs a 16-bit by 16-bit multiply in every cycle, with an accumulation to a 40-bit result, providing 8 bits of extended precision.

The ALUs perform a standard set of arithmetic and logical operations. With two ALUs capable of operating on 16- or 32-bit data, the flexibility of the computation units covers the signal processing requirements of a varied set of application needs. Each of the two 32-bit input registers can be regarded as two 16-bit halves, so each ALU can accomplish very flexible single 16-bit arithmetic operations. By viewing the registers as pairs of 16-bit operands, dual 16-bit or single 32-bit operations can be accomplished in a single cycle. Quad 16-bit operations can be accomplished simply, by taking advantage of the second ALU. This accelerates the per cycle throughput.

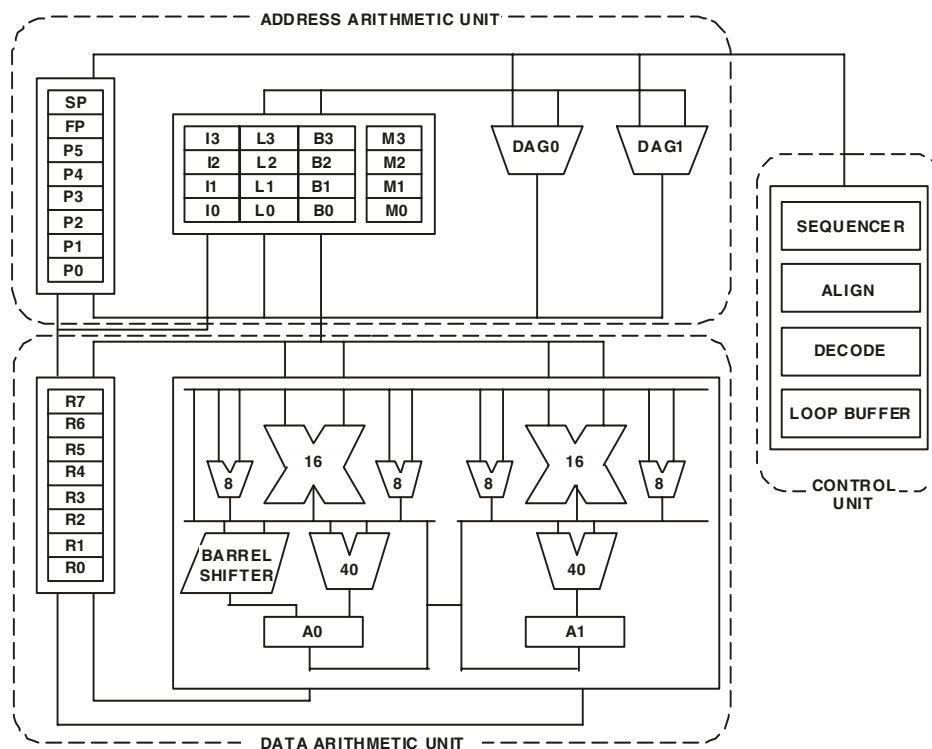

Figure 1. Processor Core

# ADSP-BF535

The powerful 40-bit shifter has extensive capabilities for performing shifting, rotating, normalization, extraction, and for depositing data.

The data for the computational units is found in a multiported register file of sixteen 16-bit entries or eight 32-bit entries.

A powerful program sequencer controls the flow of instruction execution, including instruction alignment and decoding. The sequencer supports conditional jumps and subroutine calls, as well as zero-overhead looping. A loop buffer stores instructions locally, eliminating instruction memory accesses for tightly looped code.

Two data address generators (DAGs) provide addresses for simultaneous dual operand fetches from memory. The DAGs share a register file containing four sets of 32-bit Index, Modify, Length, and Base registers. Eight additional 32-bit registers provide pointers for general indexing of variables and stack locations.

Blackfin processors support a modified Harvard architecture in combination with a hierarchical memory structure. Level 1 (L1) memories are those that typically operate at the full processor speed with little or no latency. Level 2 (L2) memories are other memories, on-chip or off-chip, that may take multiple processor cycles to access. At the L1 level, the instruction memory holds instructions only. The two data memories hold data, and a dedicated scratch pad data memory stores stack and local variable information. At the L2 level, there is a single unified memory space, holding both instructions and data.

In addition, the L1 instruction memory and L1 data memories may be configured as either Static RAMs (SRAMs) or caches. The Memory Management Unit (MMU) provides memory protection for individual tasks that may be operating on the core and may protect system registers from unintended access.

The architecture provides three modes of operation: user mode, supervisor mode, and Emulation mode. User mode has restricted access to certain system resources, thus providing a protected software environment, while supervisor mode has unrestricted access to the system and core resources.

The Blackfin processor instruction set has been optimized so that 16-bit op-codes represent the most frequently used instructions, resulting in excellent compiled code density. Complex DSP instructions are encoded into 32-bit op-codes, representing fully featured multifunction instructions. Blackfin processors support a limited multiple issue capability, where a 32-bit instruction can be issued in parallel with two 16-bit instructions, allowing the programmer to use many of the core resources in a single instruction cycle.

The Blackfin processor assembly language uses an algebraic syntax for ease of coding and readability. The architecture has been optimized for use in conjunction with the C/C++ compiler, resulting in fast and efficient software implementations.

## Memory Architecture

The ADSP-BF535 Blackfin processor views memory as a single unified 4 Gbyte address space, using 32-bit addresses. All resources, including internal memory, external memory, PCI

address spaces, and I/O control registers, occupy separate sections of this common address space. The memory portions of this address space are arranged in a hierarchical structure to provide a good cost/performance balance with very fast, low latency memory as cache or SRAM very close to the processor; and larger, lower cost, and lower performance memory systems farther away from the processor. See Figure 2.

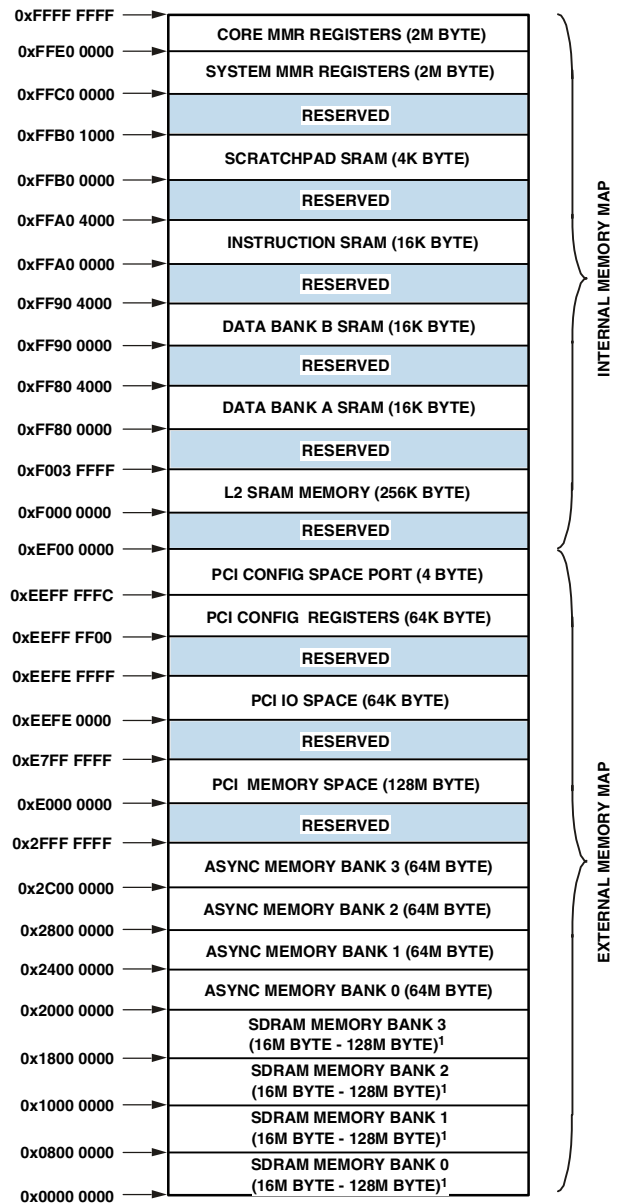

<sup>1</sup> THE ADDRESSES SHOWN FOR THE SDRAM BANKS REFLECT A FULLY POPULATED SDRAM ARRAY WITH 512M BYTES OF MEMORY. IF ANY BANK CONTAINS LESS THAN 128M BYTES OF MEMORY, THAT BANK WOULD EXTEND ONLY TO THE LENGTH OF THE REAL MEMORY SYSTEMS, AND THE END ADDRESS WOULD BECOME THE START ADDRESS OF THE NEXT BANK. THIS WOULD CONTINUE FOR ALL FOUR BANKS, WITH ANY REMAINING SPACE BETWEEN THE END OF MEMORY BANK 3 AND THE BEGINNING OF ASYNC MEMORY BANK 0, AT ADDRESS 0x2000 0000, TREATED AS RESERVED ADDRESS SPACE.

Figure 2. Internal/External Memory Map

The L1 memory system is the primary highest performance memory available to the Blackfin processor core. The L2 memory provides additional capacity with slightly lower performance. Lastly, the off-chip memory system, accessed through the External Bus Interface Unit (EBIU), provides expansion with SDRAM, flash memory, and SRAM, optionally accessing more than 768M bytes of external physical memory.

The memory DMA controller provides high bandwidth data-movement capability. It can perform block transfers of code or data between the internal L1/L2 memories and the external memory spaces (including PCI memory space).

### ***Internal (On-Chip) Memory***

The ADSP-BF535 Blackfin processor has four blocks of on-chip memory providing high bandwidth access to the core.

The first is the L1 instruction memory consisting of 16K bytes of 4-Way set-associative cache memory. In addition, the memory may be configured as an SRAM. This memory is accessed at full processor speed.

The second on-chip memory block is the L1 data memory, consisting of two banks of 16K bytes each. Each L1 data memory bank can be configured as one Way of a 2-Way set-associative cache or as an SRAM, and is accessed at full speed by the core.

The third memory block is a 4K byte scratch pad RAM which runs at the same speed as the L1 memories, but is only accessible as data SRAM (it cannot be configured as cache memory and is not accessible via DMA).

The fourth on-chip memory system is the L2 SRAM memory array which provides 256K bytes of high speed SRAM at the full bandwidth of the core, and slightly longer latency than the L1 memory banks. The L2 memory is a unified instruction and data memory and can hold any mixture of code and data required by the system design.

The Blackfin processor core has a dedicated low latency 64-bit wide datapath port into the L2 SRAM memory.

### ***External (Off-Chip) Memory***

External memory is accessed via the External Bus Interface Unit (EBIU). This interface provides a glueless connection to up to four banks of synchronous DRAM (SDRAM) as well as up to four banks of asynchronous memory devices including flash, EPROM, ROM, SRAM, and memory-mapped I/O devices.

The PC133 compliant SDRAM controller can be programmed to interface to up to four banks of SDRAM, with each bank containing between 16M bytes and 128M bytes providing access to up to 512M bytes of SDRAM. Each bank is independently programmable and is contiguous with adjacent banks regardless of the sizes of the different banks or their placement. This allows flexible configuration and upgradability of system memory while allowing the core to view all SDRAM as a single, contiguous, physical address space.

The asynchronous memory controller can also be programmed to control up to four banks of devices with very flexible timing parameters for a wide variety of devices. Each bank occupies a

64 Mbyte segment regardless of the size of the devices used so that these banks will only be contiguous if fully populated with 64M bytes of memory.

### ***PCI***

The PCI bus defines three separate address spaces, which are accessed through windows in the ADSP-BF535 Blackfin processor memory space. These spaces are PCI memory, PCI I/O, and PCI configuration.

In addition, the PCI interface can either be used as a bridge from the processor core as the controlling CPU in the system, or as a host port where another CPU in the system is the host and the ADSP-BF535 is functioning as an intelligent I/O device on the PCI bus.

When the ADSP-BF535 Blackfin processor acts as the system controller, it views the PCI address spaces through its mapped windows and can initialize all devices in the system and maintain a map of the topology of the environment.

The PCI memory region is a 4 Gbyte space that appears on the PCI bus and can be used to map memory I/O devices on the bus. The ADSP-BF535 Blackfin processor uses a 128 Mbyte window in memory space to see a portion of the PCI memory space. A base address register is provided to position this window anywhere in the 4 Gbyte PCI memory space while its position with respect to the processor addresses remains fixed.

The PCI I/O region is also a 4 Gbyte space. However, most systems and I/O devices only use a 64 Kbyte subset of this space for I/O mapped addresses. The ADSP-BF535 Blackfin processor implements a 64K byte window into this space along with a base address register which can be used to position it anywhere in the PCI I/O address space, while the window remains at the same address in the processor's address space.

PCI configuration space is a limited address space, which is used for system enumeration and initialization. This address space is a very low performance communication mode between the processor and PCI devices. The ADSP-BF535 Blackfin processor provides a one-value window to access a single data value at any address in PCI configuration space. This window is fixed and receives the address of the value, and the value if the operation is a write. Otherwise, the device returns the value into the same address on a read operation.

### ***I/O Memory Space***

Blackfin processors do not define a separate I/O space. All resources are mapped through the flat 32-bit address space. On-chip I/O devices have their control registers mapped into memory-mapped registers (MMRs) at addresses near the top of the 4 Gbyte address space. These are separated into two smaller blocks, one which contains the control MMRs for all core functions, and the other which contains the registers needed for setup and control of the on-chip peripherals outside of the core. The core MMRs are accessible only by the core and only in supervisor mode and appear as reserved space by on-chip peripherals, as well as external devices accessing resources through the PCI bus. The system MMRs are accessible by the core in supervisor mode and can be mapped as either visible or reserved to other devices, depending on the system protection model desired.

# ADSP-BF535

## Booting

The ADSP-BF535 Blackfin processor contains a small boot kernel, which configures the appropriate peripheral for booting. If the ADSP-BF535 Blackfin processor is configured to boot from boot ROM memory space, the processor starts executing from the on-chip boot ROM. For more information, see [Booting Modes on Page 14](#).

## Event Handling

The event controller on the ADSP-BF535 Blackfin processor handles all asynchronous and synchronous events to the processor. The ADSP-BF535 Blackfin processor provides event handling that supports both nesting and prioritization. Nesting allows multiple event service routines to be active simultaneously. Prioritization ensures that servicing of a higher-priority event takes precedence over servicing of a lower priority event. The controller provides support for five different types of events:

- **Emulation**—An emulation event causes the processor to enter emulation mode, allowing command and control of the processor via the JTAG interface.
- **Reset**—This event resets the processor.
- **Non-Maskable Interrupt (NMI)**—The NMI event can be generated by the software watchdog timer or by the NMI input signal to the processor. The NMI event is frequently used as a power-down indicator to initiate an orderly shutdown of the system.
- **Exceptions**—Events that occur synchronously to program flow, for example, the exception will be taken before the instruction is allowed to complete. Conditions such as data alignment violations, undefined instructions, and so on, cause exceptions.
- **Interrupts**—Events that occur asynchronously to program flow. They are caused by timers, peripherals, input pins, explicit software instructions, and so on.

Each event has an associated register to hold the return address and an associated return-from-event instruction. The state of the processor is saved on the supervisor stack, when an event is triggered.

The ADSP-BF535 Blackfin processor event controller consists of two stages, the Core Event Controller (CEC) and the System Interrupt Controller (SIC). The Core Event Controller works with the System Interrupt Controller to prioritize and control all system events. Conceptually, interrupts from the peripherals enter into the SIC, and are then routed directly into the general-purpose interrupts of the CEC.

## Core Event Controller (CEC)

The CEC supports nine general-purpose interrupts (IVG15–7), in addition to the dedicated interrupt and exception events. Of these general-purpose interrupts, the two lowest priority interrupts (IVG15–14) are recommended to be reserved for software interrupt handlers, leaving seven prioritized interrupt inputs to

support the peripherals of the ADSP-BF535 Blackfin processor. [Table 1](#) describes the inputs to the CEC, identifies their names in the Event Vector Table (EVT), and lists their priorities.

**Table 1. Core Event Controller (CEC)**

Priority (0 is Highest)	Event Class	EVT Entry
0	Emulation/Test	EMU
1	Reset	RST
2	Non-Maskable	NMI
3	Exceptions	EVX
4	Global Enable	
5	Hardware Error	IVHW
6	Core Timer	IVTMR
7	General Interrupt 7	IVG7
8	General Interrupt 8	IVG8
9	General Interrupt 9	IVG9
10	General Interrupt 10	IVG10
11	General Interrupt 11	IVG11
12	General Interrupt 12	IVG12
13	General Interrupt 13	IVG13
14	General Interrupt 14	IVG14
15	General Interrupt 15	IVG15

## System Interrupt Controller (SIC)

The System Interrupt Controller provides the mapping and routing of events from the many peripheral interrupt sources to the prioritized general-purpose interrupt inputs of the CEC. Although the ADSP-BF535 Blackfin processor provides a default mapping, the user can alter the mappings and priorities of interrupt events by writing the appropriate values into the Interrupt Assignment Registers (IAR). [Table 2](#) describes the inputs into the SIC and the default mappings into the CEC.

**Table 2. System Interrupt Controller (SIC)**

Peripheral Interrupt Event	Peripheral Interrupt ID	Default Mapping
Real-Time Clock	0	IVG7
Reserved	1	
USB	2	IVG7
PCI Interrupt	3	IVG7
SPORT 0 Rx DMA	4	IVG8
SPORT 0 Tx DMA	5	IVG8
SPORT 1 Rx DMA	6	IVG8
SPORT 1 Tx DMA	7	IVG8
SPI 0 DMA	8	IVG9
SPI 1 DMA	9	IVG9
UART 0 Rx	10	IVG10
UART 0 Tx	11	IVG10
UART 1 Rx	12	IVG10
UART 1 Tx	13	IVG10
Timer 0	14	IVG11
Timer 1	15	IVG11
Timer 2	16	IVG11
GPIO Interrupt A	17	IVG12
GPIO Interrupt B	18	IVG12

**Table 2. System Interrupt Controller (SIC) (continued)**

Peripheral Interrupt Event	Peripheral Interrupt ID	Default Mapping
Memory DMA	19	IVG13
Software Watchdog Timer	20	IVG13
Reserved	26–21	
Software Interrupt 1	27	IVG14
Software Interrupt 2	28	IVG15

**Event Control**

The ADSP-BF535 Blackfin processor provides the user with a very flexible mechanism to control the processing of events. In the CEC, three registers are used to coordinate and control events. Each of the registers is 16 bits wide, and each bit represents a particular event class:

- CEC Interrupt Latch Register (ILAT)—The ILAT register indicates when events have been latched. The appropriate bit is set when the processor has latched the event and cleared when the event has been accepted into the system. This register is updated automatically by the controller but may be read while in supervisor mode.
- CEC Interrupt Mask Register (IMASK)—The IMASK register controls the masking and unmasking of individual events. When a bit is set in the IMASK register, that event is unmasked and will be processed by the CEC when asserted. A cleared bit in the IMASK register masks the event thereby preventing the processor from servicing the event even though the event may be latched in the ILAT register. This register may be read from or written to while in supervisor mode. (Note that general-purpose interrupts can be globally enabled and disabled with the STI and CLI instructions, respectively.)
- CEC Interrupt Pending Register (IPEND)—The IPEND register keeps track of all nested events. A set bit in the IPEND register indicates the event is currently active or nested at some level. This register is updated automatically by the controller but may be read while in supervisor mode.

The SIC allows further control of event processing by providing three 32-bit interrupt control and status registers. Each register contains a bit corresponding to each of the peripheral interrupt events shown in [Table 2](#).

- SIC Interrupt Mask Register (SIC\_IMASK)—This register controls the masking and unmasking of each peripheral interrupt event. When a bit is set in the register, that peripheral event is unmasked and will be processed by the system when asserted. A cleared bit in the register masks the peripheral event thereby preventing the processor from servicing the event.
- SIC Interrupt Status Register (SIC\_ISTAT)—As multiple peripherals can be mapped to a single event, this register allows the software to determine which peripheral

event source triggered the interrupt. A set bit indicates the peripheral is asserting the interrupt, a cleared bit indicates the peripheral is not asserting the event.

- SIC Interrupt Wakeup Enable Register (SIC\_IWR)—By enabling the corresponding bit in this register, each peripheral can be configured to wake up the processor, should the processor be in a powered down mode when the event is generated. (See [Dynamic Power Management on Page 11](#).)

Because multiple interrupt sources can map to a single general-purpose interrupt, multiple pulse assertions can occur simultaneously, before or during interrupt processing for an interrupt event already detected on this interrupt input. The IPEND register contents are monitored by the SIC as the interrupt acknowledgement.

The appropriate ILAT register bit is set when an interrupt rising edge is detected (detection requires two core clock cycles). The bit is cleared when the respective IPEND register bit is set. The IPEND bit indicates that the event has entered into the processor pipeline. At this point, the CEC will recognize and queue the next rising edge event on the corresponding event input. The minimum latency from the rising edge transition of the general-purpose interrupt to the IPEND output asserted is three core clock cycles; however, the latency can be much higher, depending on the activity within and the mode of the processor.

**DMA Controllers**

The ADSP-BF535 Blackfin processor has multiple, independent DMA controllers that support automated data transfers with minimal overhead for the Blackfin processor core. DMA transfers can occur between the ADSP-BF535 Blackfin processor's internal memories and any of its DMA-capable peripherals. Additionally, DMA transfers can be accomplished between any of the DMA-capable peripherals and external devices connected to the external memory interfaces, including the SDRAM controller, the asynchronous memory controller and the PCI bus interface. DMA-capable peripherals include the SPORTs, SPI ports, UARTs, and USB port. Each individual DMA-capable peripheral has at least one dedicated DMA channel. DMA to and from PCI is accomplished by the memory DMA channel.

To describe each DMA sequence, the DMA controller uses a set of parameters called a descriptor block. When successive DMA sequences are needed, these descriptor blocks can be linked or chained together, so the completion of one DMA sequence auto-initiates and starts the next sequence. The descriptor blocks include full 32-bit addresses for the base pointers for source and destination, enabling access to the entire ADSP-BF535 Blackfin processor address space.

In addition to the dedicated peripheral DMA channels, there is a separate memory DMA channel provided for transfers between the various memories of the ADSP-BF535 Blackfin processor system. This enables transfers of blocks of data between any of the memories, including on-chip Level 2 memory, external SDRAM, ROM, SRAM, and flash memory, and PCI address spaces with little processor intervention.

# ADSP-BF535

## External Memory Control

The External Bus Interface Unit (EBIU) on the ADSP-BF535 Blackfin processor provides a high performance, glueless interface to a wide variety of industry-standard memory devices. The controller is made up of two sections: the first is an SDRAM controller for connection of industry-standard synchronous DRAM devices and DIMMs (Dual Inline Memory Module), while the second is an asynchronous memory controller intended to interface to a variety of memory devices.

### PC133 SDRAM Controller

The SDRAM controller provides an interface to up to four separate banks of industry-standard SDRAM devices or DIMMs, at speeds up to  $f_{\text{SCLK}}$ . Fully compliant with the PC133 SDRAM standard, each bank can be configured to contain between 16M bytes and 128M bytes of memory.

The controller maintains all of the banks as a contiguous address space so that the processor sees this as a single address space, even if different size devices are used in the different banks. This enables a system design where the configuration can be upgraded after delivery with either similar or different memories.

A set of programmable timing parameters is available to configure the SDRAM banks to support slower memory devices. The memory banks can be configured as either 32 bits wide for maximum performance and bandwidth or 16 bits wide for minimum device count and lower system cost.

All four banks share common SDRAM control signals and have their own bank select lines providing a completely glueless interface for most system configurations.

The SDRAM controller address, data, clock, and command pins can drive loads up to 50 pF. For larger memory systems, the SDRAM controller external buffer timing should be selected and external buffering should be provided so that the load on the SDRAM controller pins does not exceed 50 pF.

### Asynchronous Controller

The asynchronous memory controller provides a configurable interface for up to four separate banks of memory or I/O devices. Each bank can be independently programmed with different timing parameters, enabling connection to a wide variety of memory devices including SRAM, ROM, and flash EPROM, as well as I/O devices that interface with standard memory control lines. Each bank occupies a 64 Mbyte window in the processor's address space but, if not fully populated, these windows are not made contiguous by the memory controller logic. The banks can also be configured as 16-bit wide or 32-bit wide buses for ease of interfacing to a range of memories and I/O devices tailored either to high performance or to low cost and power.

### PCI Interface

The ADSP-BF535 Blackfin processor provides a glueless logical and electrical, 33 MHz, 3.3 V, 32-bit PCI (Peripheral Component Interconnect), Revision 2.2 compliant interface. The PCI interface is designed for a 3 V signalling environment. The PCI interface provides a bus bridge function between the

processor core and on-chip peripherals and an external PCI bus. The PCI interface of the ADSP-BF535 Blackfin processor supports two PCI functions:

- A host to PCI bridge function, in which the ADSP-BF535 Blackfin processor resources (the processor core, internal and external memory, and the memory DMA controller) provide the necessary hardware components to emulate a host computer PCI interface, from the perspective of a PCI target device.
- A PCI target function, in which an ADSP-BF535 Blackfin processor based intelligent peripheral can be designed to easily interface to a Revision 2.2 compliant PCI bus.

### PCI Host Function

As the PCI host, the ADSP-BF535 Blackfin processor provides the necessary PCI host (platform) functions required to support and control a variety of off-the-shelf PCI I/O devices (for example, Ethernet controllers, bus bridges, and so on) in a system in which the ADSP-BF535 Blackfin processor is the host.

Note that the Blackfin processor architecture defines only memory space (no I/O or configuration address spaces). The three address spaces of PCI space (memory, I/O, and configuration space) are mapped into the flat 32-bit memory space of the ADSP-BF535 Blackfin processor. Because the PCI memory space is as large as the ADSP-BF535 Blackfin processor memory address space, a windowed approach is employed, with separate windows in the ADSP-BF535 Blackfin processor address space used for accessing the three PCI address spaces. Base address registers are provided so that these windows can be positioned to view any range in the PCI address spaces while the windows remain fixed in position in the ADSP-BF535 Blackfin processor's address range.

For devices on the PCI bus viewing the ADSP-BF535 Blackfin processor's resources, several mapping registers are provided to enable resources to be viewed in the PCI address space. The ADSP-BF535 Blackfin processor's external memory space, internal L2, and some I/O MMRs can be selectively enabled as memory spaces that devices on the PCI bus can use as targets for PCI memory transactions.

### PCI Target Function

As a PCI target device, the PCI host processor can configure the ADSP-BF535 Blackfin processor subsystem during enumeration of the PCI bus system. Once configured, the ADSP-BF535 Blackfin processor subsystem acts as an intelligent I/O device. When configured as a target device, the PCI controller uses the memory DMA controller to perform DMA transfers as required by the PCI host.

### USB Device

The ADSP-BF535 Blackfin processor provides a USB 1.1 compliant device type interface to support direct connection to a host system. The USB core interface provides a flexible programmable environment with up to eight endpoints. Each endpoint can support all of the USB data types including control, bulk, interrupt, and isochronous. Each endpoint provides a memory-mapped buffer for transferring data to the application. The ADSP-BF535 Blackfin processor USB port has a dedicated



DMA controller and interrupt input to minimize processor polling overhead and to enable asynchronous requests for CPU attention only when transfer management is required.

The USB device requires an external 48 MHz oscillator. The value of SCLK must always exceed 48 MHz for proper USB operation.

## Real-Time Clock

The ADSP-BF535 Blackfin processor Real-Time Clock (RTC) provides a robust set of digital watch features, including current time, stopwatch, and alarm. The RTC is clocked by a 32.768 kHz crystal external to the ADSP-BF535 Blackfin processor. The RTC peripheral has dedicated power supply pins, so that it can remain powered up and clocked, even when the rest of the processor is in a low power state. The RTC provides several programmable interrupt options, including interrupt per second, minute, or day clock ticks, interrupt on programmable stopwatch countdown, or interrupt at a programmed alarm time.

The 32.768 kHz input clock frequency is divided down to a 1 Hz signal by a prescaler. The counter function of the timer consists of four counters: a 6-bit second counter, a 6-bit minute counter, a 5-bit hours counter, and an 8-bit day counter.

When enabled, the alarm function generates an interrupt when the output of the timer matches the programmed value in the alarm control register. There are two alarms: one is for a time of day, the second is for a day and time of that day.

The stopwatch function counts down from a programmed value, with one minute resolution. When the stopwatch is enabled and the counter underflows, an interrupt is generated.

Like the other peripherals, the RTC can wake up the ADSP-BF535 Blackfin processor from a low power state upon generation of any interrupt.

Connect RTC pins XTALI and XTALO with external components, as shown in [Figure 3](#).

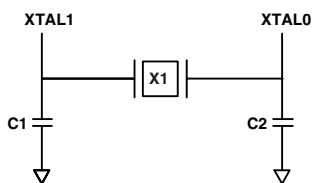

**SUGGESTED COMPONENTS:**  
 ECLIPTEK EC38J (THROUGH-HOLE PACKAGE)  
 EPSON MC405 12pF LOAD (SURFACE-MOUNT PACKAGE)  
 C1 = 22pF  
 C2 = 22pF

**NOTE:** C1 AND C2 ARE SPECIFIC TO CRYSTAL SPECIFIED FOR X1. CONTACT CRYSTAL MANUFACTURER FOR DETAILS. C1 AND C2 SPECIFICATIONS ASSUME BOARD TRACE CAPACITANCE OF 3pF.

Figure 3. External Components for RTC

## Watchdog Timer

The ADSP-BF535 Blackfin processor includes a 32-bit timer, which can be used to implement a software watchdog function. A software watchdog can improve system availability by forcing

the processor to a known state, via generation of a hardware reset, non-maskable interrupt (NMI), or general-purpose interrupt, if the timer expires before being reset by software. The programmer initializes the count value of the timer, enables the appropriate interrupt, then enables the timer. Thereafter, the software must reload the counter before it counts to zero from the programmed value. This protects the system from remaining in an unknown state where software, which would normally reset the timer, has stopped running because of external noise conditions or a software error.

After a reset, software can determine if the watchdog was the source of the hardware reset by interrogating a status bit in the timer control register, which is set only upon a watchdog generated reset.

The timer is clocked by the system clock (SCLK), at a maximum frequency of  $f_{SCLK}$ .

## Timers

There are four programmable timer units in the ADSP-BF535 Blackfin processor. Three general-purpose timers have an external pin that can be configured either as a Pulse-Width Modulator (PWM) or timer output, as an input to clock the timer, or for measuring pulse widths of external events. Each of the three general-purpose timer units can be independently programmed as a PWM, internally or externally clocked timer, or pulse width counter.

The general-purpose timer units can be used in conjunction with the UARTs to measure the width of the pulses in the data stream to provide an autobaud detect function for a serial channel.

The general-purpose timers can generate interrupts to the processor core providing periodic events for synchronization, either to the processor clock or to a count of external signals.

In addition to the three general-purpose programmable timers, a fourth timer is also provided. This extra timer is clocked by the internal processor clock (CCLK) and is typically used as a system tick clock for the generation of operating system periodic interrupts.

## Serial Ports (Sports)

The ADSP-BF535 Blackfin processor incorporates two complete synchronous serial ports (SPORT0 and SPORT1) for serial and multiprocessor communications. The SPORTs support these features:

- Bidirectional operation—Each SPORT has independent transmit and receive pins.
- Buffered (8-deep) transmit and receive ports—Each port has a data register for transferring data-words to and from other processor components and shift registers for shifting data in and out of the data registers.
- Clocking—Each transmit and receive port can either use an external serial clock or generate its own, in frequencies ranging from  $(f_{SCLK}/131070)$  Hz to  $(f_{SCLK}/2)$  Hz.
- Word length—Each SPORT supports serial data-words from 3 to 16 bits in length transferred in a format of most significant bit first or least significant bit first.

# ADSP-BF535

- Framing—Each transmit and receive port can run with or without frame sync signals for each data-word. Frame sync signals can be generated internally or externally, active high or low, with either of two pulse widths and early or late frame sync.
- Companding in hardware—Each SPORT can perform A-law or  $\mu$ -law companding according to ITU recommendation G.711. Companding can be selected on the transmit and/or receive channel of the SPORT without additional latencies.
- DMA operations with single-cycle overhead—Each SPORT can automatically receive and transmit multiple buffers of memory data. The Blackfin processor can link or chain sequences of DMA transfers between a SPORT and memory. The chained DMA can be dynamically allocated and updated through the descriptor blocks that set up the chain.
- Interrupts—Each transmit and receive port generates an interrupt upon completing the transfer of a data-word or after transferring an entire data buffer or buffers through the DMA.
- Multichannel capability—Each SPORT supports 128 channels and is compatible with the H.100, H.110, MVIP-90, and HMVIP standards.

## Serial Peripheral Interface (SPI) Ports

The ADSP-BF535 Blackfin processor has two SPI compatible ports that enable the processor to communicate with multiple SPI compatible devices.

The SPI interface uses three pins for transferring data: two data pins (Master Output-Slave Input, MOSIx, and Master Input-Slave Output, MISOx) and a clock pin (Serial Clock, SCKx). Two SPI chip select input pins ( $\overline{\text{SPISx}}$ ) let other SPI devices select the processor, and fourteen SPI chip select output pins ( $\text{SPIxSEL7-1}$ ) let the processor select other SPI devices. The SPI select pins are reconfigured programmable flag pins. Using these pins, the SPI ports provide a full duplex, synchronous serial interface, which supports both master and slave modes and multimaster environments.

Each SPI port's baud rate and clock phase/polarities are programmable (see Figure 4), and each has an integrated DMA controller, configurable to support transmit or receive data streams. The SPI's DMA controller can only service unidirectional accesses at any given time.

$$\text{SPI Clock Rate} = \frac{f_{\text{SCLK}}}{2 \times \text{SPIBAUD}}$$

Figure 4. SPI Clock Rate Calculation

During transfers, the SPI ports simultaneously transmit and receive by serially shifting data in and out on two serial data lines. The serial clock line synchronizes the shifting and sampling of data on the two serial data lines.

In master mode, the processor performs the following sequence to set up and initiate SPI transfers:

1. Enables and configures the SPI port's operation (data size and transfer format).
2. Selects the target SPI slave with an  $\text{SPIxSELy}$  output pin (reconfigured programmable flag pin).
3. Defines one or more TCBs in the processor's memory space (optional in DMA mode only).
4. Enables the SPI DMA engine and specifies transfer direction (optional in DMA mode only).
5. Reads or writes the SPI port receive or transmit data buffer (in non-DMA mode only).

The SCKx line generates the programmed clock pulses for simultaneously shifting data out on MOSIx and shifting data in on MISOx. In the DMA mode only, transfers continue until the SPI DMA word count transitions from 1 to 0.

In slave mode, the processor performs the following sequence to set up the SPI port to receive data from a master transmitter:

1. Enables and configures the SPI slave port to match the operation parameters set up on the master (data size and transfer format) SPI transmitter.
2. Defines and generates a receive TCB in the processor's memory space to interrupt at the end of the data transfer (optional in DMA mode only).
3. Enables the SPI DMA engine for a receive access (optional in DMA mode only).
4. Starts receiving data on the appropriate SPI SCKx edges after receiving an SPI chip select on an  $\overline{\text{SPISx}}$  input pin (reconfigured programmable flag pin) from a master.

In DMA mode only, reception continues until the SPI DMA word count transitions from 1 to 0. The processor can continue, by queuing up the next command TCB.

A slave mode transmit operation is similar, except the processor specifies the data buffer in memory from which to transmit data, generates and relinquishes control of the transmit TCB, and begins filling the SPI port's data buffer. If the SPI controller is not ready to transmit, it can transmit a "zero" word.

## UART Port

The ADSP-BF535 Blackfin processor provides two full-duplex Universal Asynchronous Receiver/Transmitter (UART) ports (UART0 and UART1) fully compatible with PC-standard UARTs. The UART ports provide a simplified UART interface to other peripherals or hosts, supporting full-duplex, DMA-supported, asynchronous transfers of serial data. Each UART port

includes support for 5 to 8 data bits; 1 or 2 stop bits; and none, even, or odd parity. The UART ports support two modes of operation.

- **PIO (Programmed I/O)**—The processor sends or receives data by writing or reading I/O-mapped UATX or UARX registers, respectively. The data is double-buffered on both transmit and receive.
- **DMA (Direct Memory Access)**—The DMA controller transfers both transmit and receive data. This reduces the number and frequency of interrupts required to transfer data to and from memory. Each UART has two dedicated DMA channels, one for transmit and one for receive. The DMA channels have lower priority than most DMA channels because of their relatively low service rates.

Each UART port's baud rate (see [Figure 5](#)), serial data format, error code generation and status, and interrupts are programmable:

- Bit rates ranging from ( $f_{SCLK}/1048576$ ) to ( $f_{SCLK}/16$ ) bits per second
- Data formats from 7 to 12 bits per frame
- Both transmit and receive operations can be configured to generate maskable interrupts to the processor.

$$UART\ Clock\ Rate = \frac{f_{SCLK}}{16 \times D}$$

*Figure 5. UART Clock Rate Calculation*

Autobaud detection is supported, in conjunction with the general-purpose timer functions.

The capabilities of UART0 are further extended with support for the Infrared Data Association (IrDA Serial Infrared Physical Layer Link Specification (SIR) protocol.

### Programmable Flags (PFX)

The ADSP-BF535 Blackfin processor has 16 bidirectional, general-purpose I/O programmable flag (PF15–0) pins. The programmable flag pins have special functions for clock multiplier selection, SROM boot mode, and SPI port operation. For more information, see [Serial Peripheral Interface \(SPI\) Ports on Page 10](#) and [Clock Signals on Page 13](#). Each programmable flag can be individually controlled by manipulation of the flag control, status, and interrupt registers.

- **Flag Direction Control Register**—Specifies the direction of each individual PFX pin as input or output.
- **Flag Control and Status Registers**—Rather than forcing the software to use a read-modify-write process to control the setting of individual flags, the ADSP-BF535 Blackfin processor employs a “write one to set” and “write one to clear” mechanism that allows any combination of individual flags to be set or cleared in a single instruction, without affecting the level of any other flags. Two control registers are provided, one register is written to in order to set flag values while another register is written to in order to clear flag values. Reading the flag status register allows software to interrogate the sense of the flags.

- **Flag Interrupt Mask Registers**—The two flag interrupt mask registers allow each individual PFX pin to function as an interrupt to the processor. Similar to the two flag control registers that are used to set and clear individual flag values, one flag interrupt mask register sets bits to enable interrupt function, and the other flag interrupt mask register clears bits to disable interrupt function. PFX pins defined as inputs can be configured to generate hardware interrupts, while output PFX pins can be configured to generate software interrupts.
- **Flag Interrupt Sensitivity Registers**—The two flag interrupt sensitivity registers specify whether individual PFX pins are level- or edge-sensitive and specify (if edge-sensitive) whether just the rising edge or both the rising and falling edges of the signal are significant. One register selects the type of sensitivity, and one register selects which edges are significant for edge-sensitivity.

### Dynamic Power Management

The ADSP-BF535 Blackfin processor provides four operating modes, each with a different performance/power dissipation profile. In addition, dynamic power management provides the control functions, with the appropriate external power regulation capability to dynamically alter the processor core supply voltage, further reducing power dissipation. Control of clocking to each of the ADSP-BF535 Blackfin processor peripherals also reduces power dissipation. See [Table 3](#) for a summary of the power settings for each mode.

#### Full On Operating Mode

##### – Maximum Performance

In the full on mode, the PLL is enabled, and is not bypassed, providing the maximum operational frequency. This is the normal execution state in which maximum performance can be achieved. The processor core and all enabled peripherals run at full speed.

#### Active Operating Mode

##### – Moderate Power Savings

In the active mode, the PLL is enabled, but bypassed. The input clock (CLKIN) is used to generate the clocks for the processor core (CCLK) and peripherals (SCLK). When the PLL is bypassed, CCLK runs at one-half the CLKIN frequency. Significant power savings can be achieved with the processor running at one-half the CLKIN frequency. In this mode, the PLL multiplication ratio can be changed by setting the appropriate values in the SSEL fields of the PLL control register (PLL\_CTL).

When in the active mode, system DMA access to appropriately configured L1 memory is supported.

#### Sleep Operating Mode

##### – High Power Savings

The sleep mode reduces power dissipation by disabling the clock to the processor core (CCLK). The PLL and system clock (SCLK), however, continue to operate in this mode. Any interrupt, typically via some external event or RTC activity, will wake up the processor. When in sleep mode, assertion of any interrupt will cause the processor to sense the value of the bypass bit

# ADSP-BF535

(BYPASS) in the PLL Control register (PLL\_CTL). If bypass is disabled, the processor transitions to the full on mode. If bypass is enabled, the processor transitions to the Active mode.

When in Sleep mode, system DMA access to L1 memory is not supported.

## Deep Sleep Operating Mode – Maximum Power Savings

The deep sleep mode maximizes power savings by disabling the clocks to the processor core (CCLK) and to all synchronous peripherals (SCLK). Asynchronous peripherals, such as the RTC, may still be running but will not be able to access internal resources or external memory. This powered down mode can only be exited by assertion of the reset interrupt ( $\overline{\text{RESET}}$ ) or by an asynchronous interrupt generated by the RTC. When in deep sleep mode, assertion of  $\overline{\text{RESET}}$  causes the processor to sense the value of the BYPASS pin. If bypass is disabled, the processor will transition to full on mode. If bypass is enabled, the processor will transition to active mode. When in deep sleep mode, assertion of the RTC asynchronous interrupt causes the processor to transition to the full on mode, regardless of the value of the BYPASS pin.

The DEEPSLEEP output is asserted in this mode.

## Mode Transitions

The available mode transitions diagrammed in Figure 6 are accomplished either by the interrupt events described in the following sections or by programming the PLLCTL register with the appropriate values and then executing the PLL programming sequence.

This instruction sequence takes the processor to a known idle state with the interrupts disabled. Note that all DMA activity should be disabled during mode transitions.

**Table 3. Operating Mode Power Settings**

Mode	PLL	PLL Bypassed	Core Clock (CCLK)	System Clock (SCLK)
Full On	Enabled	No	Enabled	Enabled
Active	Enabled	Yes	Enabled	Enabled
Sleep	Enabled	Yes or No	Disabled	Enabled
Deep +	Disabled		Disabled	Disabled

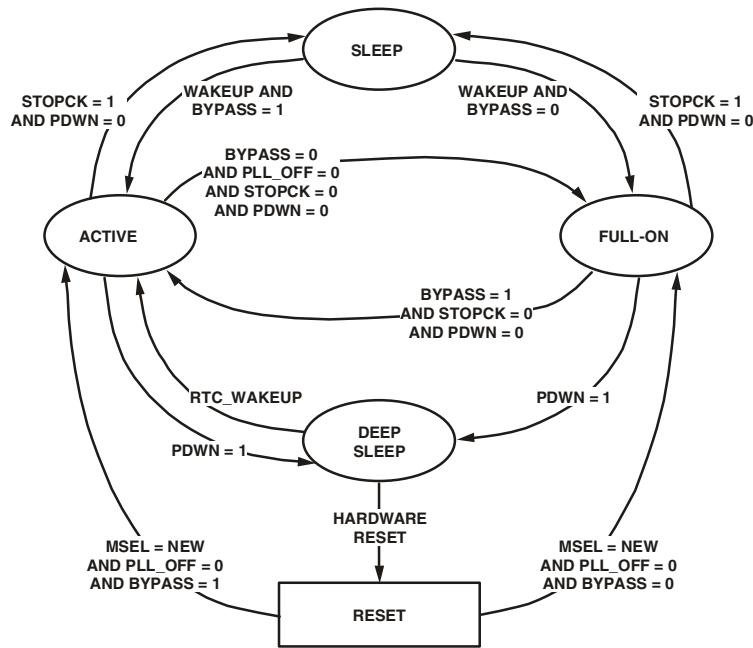

Figure 6. Mode Transitions

## Power Savings

As shown in Table 4, the ADSP-BF535 Blackfin processor supports five different power domains. The use of multiple power domains maximizes flexibility, while maintaining compliance with industry standards and conventions. By isolating the internal logic of the ADSP-BF535 Blackfin processor into its own power domain, separate from the PLL, RTC, PCI, and other I/O, the processor can take advantage of dynamic power management, without affecting the PLL, RTC, or other I/O devices.

**Table 4. Power Domains**

Power Domain	V <sub>DD</sub> Range
All internal logic, except PLL and RTC	V <sub>DDINT</sub>
Analog PLL internal logic	V <sub>DDPLL</sub>
RTC internal logic and crystal I/O	V <sub>DDRTC</sub>
PCI I/O	V <sub>DDPCIEXT</sub>
All other I/O	V <sub>DDEXT</sub>

The power dissipated by a processor is largely a function of the clock frequency of the processor and the square of the operating voltage. For example, reducing the clock frequency by 25% results in a 25% reduction in power dissipation, while reducing the voltage by 25% reduces power dissipation by more than 40%. Further, these power savings are additive, in that if the clock frequency and power are both reduced, the power savings are dramatic.

Dynamic Power Management allows both the processor's input voltage ( $V_{DDINT}$ ) and clock frequency ( $f_{CLK}$ ) to be dynamically and independently controlled.

As previously explained, the savings in power dissipation can be modeled by the following equation:

$$\text{Power Dissipation Factor} = \left( \frac{f_{CCLKRED}}{f_{CCLKNOM}} \right) \times \left( \frac{V_{DDINTRED}}{V_{DDINTNOM}} \right)^2$$

where:

$f_{CCLKNOM}$  is the nominal core clock frequency (300 MHz)

$f_{CCLKRED}$  is the reduced core clock frequency

$V_{DDINTNOM}$  is the nominal internal supply voltage (1.5 V)

$V_{DDINTRED}$  is the reduced internal supply voltage

As an example of how significant the power savings of Dynamic Power Management are when both frequency and voltage are reduced, consider an example where the frequency is reduced from its nominal value to 50 MHz and the voltage is reduced from its nominal value to 1.2 V. At this reduced frequency and voltage, the processor dissipates about 10% of the power dissipated at nominal frequency and voltage.

### Peripheral Power Control

The ADSP-BF535 Blackfin processor provides additional power control capability by allowing dynamic scheduling of clock inputs to each of the peripherals. Clocking to each of the peripherals listed below can be enabled or disabled by appropriately setting the peripheral's control bit in the peripheral clock enable register (PLL\_ILOCK). The Peripheral Clock Enable Register allows individual control for each of these peripherals:

- PCI
- EBIU controller
- Programmable flags
- MemDMA controller
- SPORT 0
- SPORT 1
- SPI 0
- SPI 1
- UART 0
- UART 1
- Timer 0, Timer 1, Timer 2
- USB CLK

### Clock Signals

The ADSP-BF535 Blackfin processor can be clocked by a sine wave input or a buffered shaped clock derived from an external clock oscillator.

If a buffered, shaped clock is used, this external clock connects to the processor CLKIN pin. The CLKIN input cannot be halted, changed, or operated below the specified frequency during normal operation. This clock signal should be a 3.3 V LVTTTL compatible signal. The processor provides a user-programmable  $1 \times$  to  $31 \times$  multiplication of the input clock to support external-to-internal clock ratios. The MSEL6–0, BYPASS, and DF pins decide the PLL multiplication factor at reset. At run time, the multiplication factor can be controlled in software. The combination of pull-up and pull-down resistors in **Figure 7** sets up a core clock ratio of 6:1, which, for example, produces a 150 MHz core clock from the 25 MHz input. For other clock multiplier settings, see the *ADSP-BF535 Blackfin Processor Hardware Reference*.

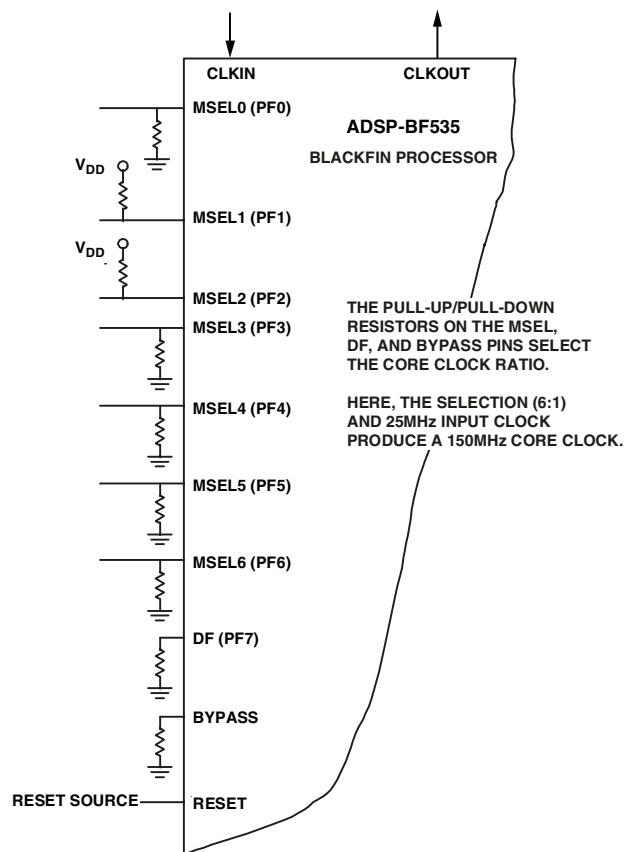

Figure 7. Clock Ratio Example

All on-chip peripherals operate at the rate set by the system clock (SCLK). The system clock frequency is programmable by means of the SSEL pins. At run time the system clock frequency can be controlled in software by writing to the SSEL fields in the PLL control register (PLL\_CTL). The values programmed into the

# ADSP-BF535

SSEL fields define a divide ratio between the core clock (CCLK) and the system clock. Table 5 illustrates the system clock ratios. The system clock is supplied to the CLKOUT\_SCLK0 pin.

**Table 5. System Clock Ratios**

Signal Name	Divider Ratio	Example Frequency Ratios (MHz)	
		CCLK	SCLK
SSEL1–0	CCLK/SCLK		
00	2:1	266	133
01	2.5:1	275	110
10	3:1	300	100
11	4:1	300	75

The maximum frequency of the system clock is  $f_{SCLK}$ . Note that the divisor ratio must be chosen to limit the system clock frequency to its maximum of  $f_{SCLK}$ . The reset value of the SSEL1–0 is determined by sampling the SSEL1 and SSEL0 pins during reset. The SSEL value can be changed dynamically by writing the appropriate values to the PLL control register (PLL\_CTL), as described in the *ADSP-BF535 Blackfin Processor Hardware Reference*.

## Booting Modes

The ADSP-BF535 has three mechanisms (listed in Table 6) for automatically loading internal L2 memory after a reset. A fourth mode is provided to execute from external memory, bypassing the boot sequence.

**Table 6. Booting Modes**

BMODE2–0	Description
000	Execute from 16-bit external memory (Bypass Boot ROM)
001	Boot from 8-bit flash
010	Boot from SPI0 serial ROM (8-bit address range)
011	Boot from SPI0 serial ROM (16-bit address range)
100–111	Reserved

The BMODE pins of the reset configuration register, sampled during power-on resets and software initiated resets, implement these modes:

- Execute from 16-bit external memory—Execution starts from address 0x2000000 with 16-bit packing. The boot ROM is bypassed in this mode.
- Boot from 8-bit external flash memory—The 8-bit flash boot routine located in boot ROM memory space is set up using asynchronous Memory Bank 0. All configuration settings are set for the slowest device possible (3-cycle hold time; 15-cycle R/W access times; 4-cycle setup).

- Boot from SPI serial EEPROM (8-bit addressable)—The SPI0 uses PF10 output pin to select a single SPI EPROM device, submits a read command at address 0x00, and begins clocking data into the beginning of L2 memory. An 8-bit addressable SPI compatible EPROM must be used.
- Boot from SPI serial EEPROM (16-bit addressable)—The SPI0 uses PF10 output pin to select a single SPI EPROM device, submits a read command at address 0x0000, and begins clocking data into the beginning of L2 memory. A 16-bit addressable SPI compatible EPROM must be used.

For each of the boot modes described above, a four-byte value is first read from the memory device. This value is used to specify a subsequent number of bytes to be read into the beginning of L2 memory space. Once each of the loads is complete, the processor jumps to the beginning of L2 space and begins execution.

In addition, the reset configuration register can be set by application code to bypass the normal boot sequence during a software reset. For this case, the processor jumps directly to the beginning of L2 memory space.

To augment the boot modes, a secondary software loader is provided that adds additional booting mechanisms. This secondary loader provides the capability to boot from PCI, 16-bit flash memory, fast flash, variable baud rate, and so on.

## Instruction Set Description

The Blackfin processor family assembly language instruction set employs an algebraic syntax designed for ease of coding and readability. The instructions have been specifically tuned to provide a flexible, densely encoded instruction set that compiles to a very small final memory size. The instruction set also provides fully featured multifunction instructions that allow the programmer to use many of the processor core resources in a single instruction. Coupled with many features more often seen on microcontrollers, this instruction set is very efficient when compiling C and C++ source code. In addition, the architecture supports both a user (algorithm/application code) and a supervisor (O/S kernel, device drivers, debuggers, ISRs) mode of operations, allowing multiple levels of access to core processor resources.

The assembly language, which takes advantage of the processor's unique architecture, offers the following advantages:

- Seamlessly integrated DSP/CPU features are optimized for both 8-bit and 16-bit operations.
- A super pipelined multi issue load/store modified Harvard architecture, which supports two 16-bit MAC or four 8-bit ALU + two load/store + two pointer updates per cycle.
- All registers, I/O, and memory are mapped into a unified 4 Gbyte memory space providing a simplified programming model.

- Microcontroller features, such as arbitrary bit and bit-field manipulation, insertion, and extraction; integer operations on 8-, 16-, and 32-bit data-types; and separate user and kernel stack pointers.
- Code density enhancements, which include intermixing of 16- and 32-bit instructions (no mode switching, no code segregation). Frequently used instructions are encoded as 16-bits.

### Development Tools

The ADSP-BF535 Blackfin processor is supported with a complete set of software and hardware development tools, including Analog Devices emulators and the VisualDSP++™ development environment. The same emulator hardware that supports other Analog Devices JTAG processors, also fully emulates the ADSP-BF535 Blackfin processor.

The VisualDSP++ project management environment lets programmers develop and debug an application. This environment includes an easy to use assembler (which is based on an algebraic syntax), an archiver (librarian/library builder), a linker, a loader, a cycle-accurate instruction-level simulator, a C/C++ compiler, and a C/C++ run-time library that includes DSP and mathematical functions. A key point for these tools is C/C++ code efficiency. The compiler has been developed for efficient translation of C/C++ code to Blackfin processor assembly. The Blackfin processor has architectural features that improve the efficiency of compiled C/C++ code.

The VisualDSP++ debugger has a number of important features. Data visualization is enhanced by a plotting package that offers a significant level of flexibility. This graphical representation of user data enables the programmer to quickly determine the performance of an algorithm. As algorithms grow in complexity, this capability can have increasing significance on the designer's development schedule, increasing productivity. Statistical profiling enables the programmer to nonintrusively poll the processor as it is running the program. This feature, unique to VisualDSP++, enables the software developer to passively gather important code execution metrics without interrupting the real-time characteristics of the program. Essentially, the developer can identify bottlenecks in software quickly and efficiently. By using the profiler, the programmer can focus on those areas in the program that impact performance and take corrective action.

Debugging both C/C++ and assembly programs with the VisualDSP++ debugger, programmers can:

- View mixed C/C++ and assembly code (interleaved source and object information)
- Insert breakpoints
- Set conditional breakpoints on registers, memory, and stacks
- Trace instruction execution
- View the internal pipeline to further optimize peripherals
- Perform linear or statistical profiling of program execution
- Fill, dump, and graphically plot the contents of memory

- Perform source level debugging
- Create custom debugger windows

The VisualDSP++ IDDE lets programmers define and manage software development. Its dialog boxes and property pages let programmers configure and manage all development tools, including color syntax highlighting in the VisualDSP++ editor. These capabilities permit programmers to:

- Control how the development tools process inputs and generate outputs
- Maintain a one-to-one correspondence with the tool's command line switches

The VisualDSP++ Kernel (VDK) incorporates scheduling and resource management tailored specifically to address the memory and timing constraints of embedded, real-time programming. These capabilities enable engineers to develop code more effectively, eliminating the need to start from the very beginning, when developing new application code. The VDK features include threads, critical and unscheduled regions, semaphores, events, and device flags. The VDK also supports priority-based, preemptive, cooperative, and time-sliced scheduling approaches. In addition, the VDK was designed to be scalable. If the application does not use a specific feature, the support code for that feature is excluded from the target system.

Because the VDK is a library, a developer can decide whether to use it or not. The VDK is integrated into the VisualDSP++ development environment, but can also be used via standard command line tools. When the VDK is used, the development environment assists the developer with many error-prone tasks and assists in managing system resources, automating the generation of various VDK based objects, and visualizing the system state, when debugging an application that uses the VDK.

VCSE is Analog Devices technology for creating, using, and reusing software components (independent modules of substantial functionality) to quickly and reliably assemble software applications. Download components from the Web and drop them into the application. Publish component archives from within VisualDSP++. VCSE supports component implementation in C/C++ or assembly language.

Use the Expert Linker to visually manipulate the placement of code and data on the embedded system. View memory utilization in a color-coded graphical form, easily move code and data to different areas of the processor or external memory with the drag of the mouse, examine run-time stack and heap usage. The Expert Linker is fully compatible with existing Linker Definition File (LDF), allowing the developer to move between the graphical and textual environments.

Analog Devices emulators use the IEEE 1149.1 JTAG test access port of the ADSP-BF535 Blackfin processor to monitor and control the target board processor during emulation. The emulator provides full speed emulation, allowing inspection and modification of memory, registers, and processor stacks. Nonintrusively in-circuit emulation is assured by the use of the processor's JTAG interface—the emulator does not affect target system loading or timing.

# ADSP-BF535

In addition to the software and hardware development tools available from Analog Devices, third parties provide a wide range of tools supporting the Blackfin processor family. Third Party software tools include DSP libraries, real-time operating systems, and block diagram design tools.

## ***EZ-KIT Lite™ for ADSP-BF535 Blackfin Processor***

The EZ-KIT Lite provides developers with a cost-effective method for initial evaluation of the ADSP-BF535 Blackfin processor. The EZ-KIT Lite includes a desktop evaluation board and fundamental debugging software to facilitate architecture evaluations via a PC hosted toolset. With the EZ-KIT Lite, users can learn more about Analog Devices hardware and software development tools and prototype applications. The EZ-KIT Lite includes an evaluation suite of the VisualDSP++ development environment with C/C++ compiler, assembler, and linker. The VisualDSP++ software included with the kit is limited in program memory size and limited to use with the EZ-KIT Lite product.

## ***Designing an Emulator Compatible Processor Board (Target)***

The Analog Devices family of emulators are tools that every system developer needs to test and debug hardware and software systems. Analog Devices has supplied an IEEE 1149.1 JTAG Test Access Port (TAP) on the ADSP-BF535 Blackfin processor. The

emulator uses the TAP to access the internal features of the processor, allowing the developer to load code, set breakpoints, observe variables, observe memory, and examine registers. The processor must be halted to send data and commands, but once an operation has been completed by the emulator, the processor system is set running at full speed with no impact on system timing.

To use these emulators, the target's design must include a header that connects the processor's JTAG port to the emulator.

For details on target board design issues including single processor connections, multiprocessor scan chains, signal buffering, signal termination, and emulator pod logic, see the *EE-68: Analog Devices JTAG Emulation Technical Reference* on the Analog Devices website ([www.analog.com](http://www.analog.com))—use site search on “EE-68”. This document is updated regularly to keep pace with improvements to emulator support.

## **Additional Information**

This data sheet provides a general overview of the ADSP-BF535 Blackfin processor architecture and functionality. For detailed information on the Blackfin processor family core architecture and instruction set, refer to the *ADSP-BF535 Blackfin Processor Hardware Reference* and the *Blackfin Processor Instruction Set Reference*.



## PIN DESCRIPTIONS

ADSP-BF535 Blackfin processor pin definitions are listed in Table 7. The following pins are asynchronous: ARDY, PF15–0, USB\_CLK, NMI, TRST, RESET, PCI\_CLK, XTALI, XTALO.

**Table 7. Pin Descriptions**

Pin	Type	Function
ADDR25–2	O/T	External address bus.
DATA31–0	I/O/T	External data bus. (Pin has a logic-level hold circuit that prevents the input from floating internally.)
$\overline{\text{ABE3}}\text{--}0/\text{SDQM3--}0$	O/T	Asynchronous memory byte enables SDRAM data masks.
$\overline{\text{AMS3}}\text{--}0$	O/T	Chip selects for asynchronous memories.
ARDY <sup>1</sup>	I	Acknowledge signal for asynchronous memories.
$\overline{\text{AOE}}$	O/T	Memory output enable for asynchronous memories.
$\overline{\text{ARE}}$	O	Read enable for asynchronous memories.
$\overline{\text{AWE}}$	O	Write enable for asynchronous memories.
CLKOUT/SCLK1	O	SDRAM clock output pin. Same frequency and timing as SCLK0. Provided to reduce capacitance loading on SCLK0. Connect to SDRAM's CK pin.
SCLK0	O	SDRAM clock output pin 0. Switches at system clock frequency. Connect to the SDRAM's CK pin.
SCKE	O/T	SDRAM clock enable pin. Connect to SDRAM's CKE pin.
SA10	O/T	SDRAM A10 pin. SDRAM interface uses this pin to retain control of the SDRAM device during host bus requests. Connect to SDRAM's A10 pin.
$\overline{\text{SRAS}}$	O/T	SDRAM row address strobe pin. Connect to SDRAM's RAS pin.
$\overline{\text{SCAS}}$	O/T	SDRAM column address select pin. Connect to SDRAM's CAS pin.
$\overline{\text{SWE}}$	O/T	SDRAM write enable pin. Connect to SDRAM's WE or W buffer pin.
$\overline{\text{SMS3}}\text{--}0$	O/T	Memory select pin of external memory bank configured for SDRAM. Connect to SDRAM's chip select pin.
TMR0	I/O/T	Timer 0 pin. Functions as an output pin in PWMOUT mode and as an input pin in WIDTH_CNT and EXT_CLK modes.
TMR1	I/O/T	Timer 1 pin. Functions as an output pin in PWMOUT mode and as an input pin in WIDTH_CNT and EXT_CLK modes.
TMR2	I/O/T	Timer 2 pin. Functions as an output pin in PWMOUT mode and as an input pin in WIDTH_CNT and EXT_CLK modes.
PF15/ $\overline{\text{SPI1SEL7}}$	I/O/T	Programmable flag pin. SPI output select pin.
PF14/ $\overline{\text{SPI0SEL7}}$	I/O/T	Programmable flag pin. SPI output select pin.
PF13/ $\overline{\text{SPI1SEL6}}$	I/O/T	Programmable flag pin. SPI output select pin.
PF12/ $\overline{\text{SPI0SEL6}}$	I/O/T	Programmable flag pin. SPI output select pin.
PF11/ $\overline{\text{SPI1SEL5}}$	I/O/T	Programmable flag pin. SPI output select pin.
PF10/ $\overline{\text{SPI0SEL5}}$	I/O/T	Programmable flag pin. SPI output select pin (used during SPI boot).
PF9/ $\overline{\text{SPI1SEL4}}/\text{SSEL1}$	I/O	Programmable flag pin. SPI output select pin. Sampled during reset to determine core clock to system clock ratio.
PF8/ $\overline{\text{SPI0SEL4}}/\text{SSEL0}$	I/O	Programmable flag pin. SPI output select pin. Sampled during reset to determine core clock to system clock ratio.
PF7/ $\overline{\text{SPI1SEL3}}/\text{DF}$	I/O	Programmable flag pin. SPI output select pin. Sensed for configuration state during hardware reset, used to configure the PLL. DF = 1 is for high frequency clock and divides the input clock by 2. DF = 0 passes input clock directly to PLL phase detector.
PF6/ $\overline{\text{SPI0SEL3}}/\text{MSEL6}$	I/O	Programmable flag pin. SPI output select pin. Sensed for configuration state during hardware reset, used to configure the PLL. Selects CK to CLKIN ratio.
PF5/ $\overline{\text{SPI1SEL2}}/\text{MSEL5}$	I/O	Programmable flag pin. SPI output select pin. Sensed for configuration state during hardware reset, used to configure the PLL. Selects CK to CLKIN ratio.

**Type column symbols:** G = Ground, I = Input, O = Output, P = Power supply, T = Three-state

# ADSP-BF535

Table 7. Pin Descriptions (continued)

Pin	Type	Function
PF4/ $\overline{\text{SPI0SEL2}}$ /MSEL4	I/O	Programmable flag pin. SPI output select pin. Sensed for configuration state during hardware reset, used to configure the PLL. Selects CK to CLKIN ratio.
PF3/ $\overline{\text{SPI1SEL1}}$ /MSEL3	I/O	Programmable flag pin. SPI output select pin. Sensed for configuration state during hardware reset, used to configure the PLL. Selects CK to CLKIN ratio.
PF2/ $\overline{\text{SPI0SEL1}}$ /MSEL2	I/O	Programmable flag pin. SPI output select pin. Sensed for configuration state during hardware reset, used to configure the PLL. Selects CK to CLKIN ratio.
PF1/ $\overline{\text{SPISS1}}$ /MSEL1	I/O	Programmable flag pin. SPI slave select input pin. Sensed for configuration state during hardware reset, used to configure the PLL. Selects CK to CLKIN ratio.
PF0/ $\overline{\text{SPISS0}}$ /MSEL0	I/O	Programmable flag pin. SPI slave select input pin. Sensed for configuration state during hardware reset, used to configure the PLL. Selects CK to CLKIN ratio.
RSCLK0	I/O/T	Receive serial clock for SPORT0.
RFS0	I/O/T	Receive frame synchronization for SPORT0.
DR0	I	Serial data receive for SPORT0.
TSCLK0	I/O/T	Transmit serial clock for SPORT0.
TFS0	I/O/T	Transmit frame synchronization for SPORT0.
DT0	O	Serial data transmit for SPORT0.
RSCLK1	I/O/T	Receive serial clock for SPORT1.
RFS1	I/O/T	Receive frame synchronization for SPORT1.
DR1	I	Serial data receive for SPORT1.
TSCLK1	I/O/T	Transmit serial clock for SPORT1.
TFS1	I/O/T	Transmit frame synchronization for SPORT1.
DT1	O	Serial data transmit for SPORT1.
MOSI0	I/O	Master out slave in pin for SPI0. Supplies the output data from the master device and receives the input data to a slave device.
MISO0	I/O	Master in slave out pin for SPI0. Supplies the output data from the slave device and receives the input data to the master device.
SCK0	I/O	Clock line for SPI0. Master device output clock signal. Slave device input clock signal.
MOSI1	I/O	Master out slave in pin for SPI1. Supplies the output data from the master device and receives the input data to a slave device.
MISO1	I/O	Master in slave out pin for SPI1. Supplies the output data from the slave device and receives the input data to the master device.
SCK1	I/O	Clock line for SPI1. Master device output clock signal. Slave device input clock signal.
RX0	I	UART0 receive pin.
TX0	O	UART0 transmit pin.
RX1	I	UART1 receive pin.
TX1	O	UART1 transmit pin.
USB_CLK	I	USB clock.
XVER_DATA	I	Single ended receive data output from USB transceiver to the USB module.
DPLS	I	Differential D+ receive data output from the USB transceiver to the USB module.
DMNS	I	Differential D- receive data output from the USB transceiver to the USB module.
TXDPLS	O	Transmitted D+ from the USB module to the USB transceiver.
TXDMNS	O	Transmitted D- from the USB module to the USB transceiver.
$\overline{\text{TXEN}}$	O	Transmit enable from the USB module to the USB transceiver.
SUSPEND	O	Suspend mode enable output from the USB module to the USB transceiver.
NMI	I	Non-maskable interrupt.
TCK	I	JTAG clock.
TDO	O/T	JTAG serial data out.
TDI	I	JTAG serial data in.
TMS	I	Test mode select.

**Type column symbols:** G = Ground, I = Input, O = Output, P = Power supply, T = Three-state

**Table 7. Pin Descriptions (continued)**

Pin	Type	Function
$\overline{\text{TRST}}$	I	JTAG reset.
$\overline{\text{RESET}}$	I	When this pin is asserted to logic zero level for at least 10 CLKIN cycles, a hardware reset is initiated. The minimum pulse width for power-on reset is 40 $\mu\text{s}$ .
CLKIN1	I	Clock in.
BYPASS	I	Dedicated mode pin. May be permanently strapped to $V_{\text{DD}}$ or $V_{\text{SS}}$ . Bypasses the on-chip PLL.
DEEPSLEEP	O	Denotes that the Blackfin processor core is in Deep Sleep mode.
BMODE2-0	I	Dedicated mode pin. May be permanently strapped to $V_{\text{DD}}$ or $V_{\text{SS}}$ . Configures the boot mode that is employed following hardware reset or software reset.
PCI_AD31-0	I/O/T	PCI address and data bus.
$\overline{\text{PCI_CBE3-0}}$	I/O/T	PCI byte enables.
$\overline{\text{PCI_FRAME}}$	I/O/T	PCI frame signal. Used by PCI initiators for signalling the beginning and end of a PCI transaction.
$\overline{\text{PCI_IRDY}}$	I/O/T	PCI initiator ready signal.
$\overline{\text{PCI_TRDY}}$	I/O/T	PCI target ready signal.
$\overline{\text{PCI_DEVSEL}}$	I/O/T	PCI device select signal. Asserted by targets of PCI transactions to claim the transaction.
$\overline{\text{PCI_STOP}}$	I/O/T	PCI stop signal.
$\overline{\text{PCI_PERR}}$	I/O/T	PCI parity error signal.
$\overline{\text{PCI_PAR}}$	I/O/T	PCI parity signal.
$\overline{\text{PCI_REQ}}$	O	PCI request signal. Used for requesting the use of the PCI bus.
$\overline{\text{PCI_SERR}}$	I/O/T	PCI system error signal. Requires a pull-up on the system board.
$\overline{\text{PCI_RST}}$	I/O/T	PCI reset signal.
$\overline{\text{PCI_GNT}}$	I	PCI grant signal. Used for granting access to the PCI bus.
$\overline{\text{PCI_IDSEL}}$	I	PCI initialization device select signal. Individual device selects for targets of PCI configuration transactions.
$\overline{\text{PCI_LOCK}}$	I	PCI lock signal. Used to lock a target or the entire PCI bus for use by the master that asserts the lock.
$\overline{\text{PCI_CLK}}$	I	PCI clock.
$\overline{\text{PCI_INTA}}$	I/O/T	PCI interrupt A line on PCI bus. Asserted by the ADSP-BF535 Blackfin processor as a device-to-signal an interrupt to the system processor. Monitored by the ADSP-BF535 when acting as the system processor.
$\overline{\text{PCI_INTB}}$	I	PCI interrupt B line. Monitored by ADSP-BF535 Blackfin processor when acting as the system processor.
$\overline{\text{PCI_INTC}}$	I	PCI interrupt C line. Monitored by the ADSP-BF535 Blackfin processor when acting as the system processor.
$\overline{\text{PCI_INTD}}$	I	PCI interrupt D line. Monitored by the ADSP-BF535 Blackfin processor when acting as the system processor.
XTAL1	I	Real-Time Clock oscillator input.
XTAL0	O	Real-Time Clock oscillator output.
$\overline{\text{EMU}}$	O	Emulator acknowledge, open drain. Must be connected to the ADSP-BF535 Blackfin processor emulator target board connector only.
$V_{\text{DDPLL}}$	P	PLL power supply (1.5 V nominal).
$V_{\text{DDRTC}}$	P	Real-Time Clock power supply (3.3 V nominal).
$V_{\text{DDEXT}}$	P	I/O (except PCI) power supply (3.3 V nominal).
$V_{\text{DDPCIEXT}}$	P	PCI I/O power supply (3.3 V nominal).
$V_{\text{DDINT}}$	P	Internal power supply (1.5 V nominal).
GND	G	Power supply return.

**Type column symbols:** G = Ground, I = Input, O = Output, P = Power supply, T = Three-state

# ADSP-BF535

## Unused Pins

Table 8 shows recommendations for tying off unused pins. All pins that are not listed in the table should be left floating.

**Table 8. Recommendations for Tying Off Unused Pins**

Pin	Tie Off
ARDY	V <sub>DDEXT</sub>
BMODE2-0	V <sub>DDEXT</sub> or GND
BYPASS	V <sub>DDEXT</sub> or GND
DMNS	GND
DPLS	GND
DR0	V <sub>DDEXT</sub> or GND
DR1	V <sub>DDEXT</sub> or GND
NMI	GND
PCI_AD31-0	V <sub>DDEXT</sub>
PCI_CB3-0	V <sub>DDEXT</sub>
PCI_CLK	GND
PCI_DEVSEL	V <sub>DDEXT</sub>
PCI_FRAME	V <sub>DDEXT</sub>
PCI_GNT	V <sub>DDEXT</sub>
PCI_IDSEL	GND
PCI_INTA	V <sub>DDEXT</sub>
PCI_INTB	V <sub>DDEXT</sub>
PCI_INTC	V <sub>DDEXT</sub>
PCI_INTD	V <sub>DDEXT</sub>
PCI_IRDY	V <sub>DDEXT</sub>
PCI_LOCK	V <sub>DDEXT</sub>
PCI_PAR	V <sub>DDEXT</sub>
PCI_PERR	V <sub>DDEXT</sub>
PCI_RST	V <sub>DDEXT</sub>
PCI_STOP	V <sub>DDEXT</sub>
PCI_SERR	V <sub>DDEXT</sub>
PCI_TRDY	V <sub>DDEXT</sub>
PF0/SPISS0/MSEL0	V <sub>DDEXT</sub> or GND (10 kΩ pull-up/pull-down required)
PF1/SPISS1/MSEL1	V <sub>DDEXT</sub> or GND (10 kΩ pull-up/pull-down required)
PF2/SPI0SEL1/MSEL2	V <sub>DDEXT</sub> or GND (10 kΩ pull-up/pull-down required)
PF3/SPI1SEL1/MSEL3	V <sub>DDEXT</sub> or GND (10 kΩ pull-up/pull-down required)
PF4/SPI0SEL2/MSEL4	V <sub>DDEXT</sub> or GND (10 kΩ pull-up/pull-down required)
PF5/SPI1SEL2/MSEL5	V <sub>DDEXT</sub> or GND (10 kΩ pull-up/pull-down required)
PF6/SPI0SEL3/MSEL6	V <sub>DDEXT</sub> or GND (10 kΩ pull-up/pull-down required)
PF7/SPI1SEL3/DF	V <sub>DDEXT</sub> or GND (10 kΩ pull-up/pull-down required)
PF8/SPI0SEL4/SSEL0	V <sub>DDEXT</sub> or GND (10 kΩ pull-up/pull-down required)
PF9/SPI1SEL4/SSEL1	V <sub>DDEXT</sub> or GND (10 kΩ pull-up/pull-down required)
RX0	V <sub>DDEXT</sub> or GND
RX1	V <sub>DDEXT</sub> or GND
TCK	V <sub>DDEXT</sub>
TDI	V <sub>DDEXT</sub>
TMS	V <sub>DDEXT</sub>
TRST	GND
USB_CLK	GND
V <sub>DDPCIEXT</sub>	V <sub>DDEXT</sub>
V <sub>DDRTC</sub>	V <sub>DDEXT</sub>
XTAL1	V <sub>DDEXT</sub> or GND
XVER_DATA	GND

# SPECIFICATIONS

## RECOMMENDED OPERATING CONDITIONS

Parameter		Min	Nominal	Max	Unit
V <sub>DDINT</sub>	Internal (Core) Supply Voltage <sup>1</sup>				
	ADSP-BF535PKB-350	0.95	1.6	1.65	V
	ADSP-BF535PKB-300	0.95	1.5	1.575	V
	ADSP-BF535PBB-300	0.95	1.5	1.575	V
V <sub>DDEXT</sub>	ADSP-BF535PBB-200	0.95	1.5	1.575	V
	External (I/O) Supply Voltage <sup>1</sup>	3.15	3.3	3.45	V
	V <sub>DDPLL</sub>	1.425	1.5	1.575	V
	V <sub>DDRTC</sub>	2.60	3.3	3.45	V
V <sub>DDPCIEXT</sub>	PCI I/O Power Supply Voltage <sup>1</sup>	3.15	3.3	3.45	V
V <sub>IH</sub>	High Level Input Voltage <sup>2</sup> , @ V <sub>DDEXT</sub> = max	2.2		V <sub>DDEXT</sub> + 0.5	V
V <sub>IL</sub>	Low Level Input Voltage <sup>2</sup> , @ V <sub>DDEXT</sub> = min	-0.3		+0.6	V
V <sub>IHUSBCLK</sub>	High Level Input Voltage <sup>3</sup> , @ V <sub>DDEXT</sub> = max	2.4		V <sub>DDEXT</sub> + 0.5	V
V <sub>IHPCI</sub>	High Level Input Voltage <sup>4</sup> , @ V <sub>DDPCIEXT</sub> = max	0.5 × V <sub>DDPCIEXT</sub>		V <sub>DDPCIEXT</sub> + 0.5	V
V <sub>ILPCI</sub>	Low Level Input Voltage <sup>4</sup> , @ V <sub>DDPCIEXT</sub> = min	-0.5		+0.3 × V <sub>DDPCIEXT</sub>	V
T <sub>A</sub>	Ambient Operating Temperature				°C
	Commercial	0		70	°C
	Industrial	-40		+85	°C

Specifications subject to change without notice.

<sup>1</sup> There is no requirement for sequencing of the voltage supplies on powerup, however, the supply regulators must be able to provide the required current I<sub>DDRESET</sub> at all times. See Table 26.

<sup>2</sup> Applies to input and bidirectional pins, except PCI and USB\_CLK.

<sup>3</sup> Applies to USB\_CLK.

<sup>4</sup> Applies to PCI input and bidirectional pins: PCI\_AD31-0, PCI\_CBE3-0, PCI\_FRAME, PCI\_IRDY, PCI\_TRDY, PCI\_DEVSEL, PCI\_STOP, PCI\_PERR, PCI\_PAR, PCI\_SERR, PCI\_RST, PCI\_GNT, PCI\_IDSEL, PCI\_LOCK, PCI\_CLK, PCI\_INTA, PCI\_INTB, PCI\_INTC, PCI\_INTD.

## ELECTRICAL CHARACTERISTICS

Parameter	Test Conditions	Min	Max	Unit
V <sub>OH</sub>	High Level Output Voltage <sup>1</sup>	2.4		V
V <sub>OL</sub>	Low Level Output Voltage <sup>1</sup>		0.4	V
V <sub>OHPCI</sub>	PCI High Level Output Voltage <sup>2</sup>	0.9 × V <sub>DDPCIEXT</sub>		V
V <sub>OLPCI</sub>	PCI Low Level Output Voltage <sup>2</sup>		0.1 × V <sub>DDPCIEXT</sub>	V
I <sub>IH</sub>	High Level Input Current <sup>3</sup>	@ V <sub>DDEXT</sub> = max, V <sub>IN</sub> = V <sub>DD</sub> max	10	μA
I <sub>IL</sub>	Low Level Input Current <sup>3</sup>	@ V <sub>DDEXT</sub> = max, V <sub>IN</sub> = 0 V	10	μA
I <sub>OZH</sub>	Three-State Leakage Current <sup>4</sup>	@ V <sub>DDEXT</sub> = max, V <sub>IN</sub> = V <sub>DD</sub> max	10	μA
I <sub>OZL</sub>	Three-State Leakage Current <sup>4</sup>	@ V <sub>DDEXT</sub> = max, V <sub>IN</sub> = 0 V	10	μA
C <sub>IN</sub>	Input Capacitance <sup>5, 6</sup>	f <sub>IN</sub> = 1 MHz, T <sub>A</sub> = 25°C, V <sub>IN</sub> = 2.5 V	5	pF

Specifications subject to change without notice.

<sup>1</sup> Applies to output and bidirectional pins, except PCI.

<sup>2</sup> Applies to PCI output and bidirectional pins: PCI\_AD31-0, PCI\_CBE3-0, PCI\_FRAME, PCI\_IRDY, PCI\_TRDY, PCI\_DEVSEL, PCI\_STOP, PCI\_PERR, PCI\_PAR, PCI\_REQ, PCI\_SERR, PCI\_RST, PCI\_INTA.

<sup>3</sup> Applies to input pins.

<sup>4</sup> Applies to three-statable pins.

<sup>5</sup> Applies to all signal pins.

<sup>6</sup> Guaranteed but not tested.

# ADSP-BF535

## ABSOLUTE MAXIMUM RATINGS

Internal (Core) Supply Voltage ( $V_{DDINT}$ ) <sup>1</sup>	−0.3 V to +1.65 V
External (I/O) Supply Voltage ( $V_{DDEXT}$ ) <sup>1</sup>	−0.3 V to +4.0 V
Input Voltage <sup>1</sup>	−0.5 V to $V_{DDEXT}+0.5$ V
Output Voltage Swing <sup>1</sup>	−0.5 V to $V_{DDEXT}+0.5$ V
Load Capacitance <sup>1,2</sup>	200 pF
Core Clock: <sup>1</sup>	
ADSP-BF535PKB-350	350 MHz
ADSP-BF535PKB-300	300 MHz
ADSP-BF535PBB-300	300 MHz
ADSP-BF535PBB-200	200 MHz
System Clock (SCLK) <sup>1</sup>	133 MHz
Storage Temperature Range <sup>1</sup>	−65°C to +150°C

<sup>1</sup>Stresses greater than those listed above may cause permanent damage to the device. These are stress ratings only; functional operation of the device at these or any other conditions greater than those indicated in the operational sections of this specification is not implied. Exposure to absolute maximum rating conditions for extended periods may affect device reliability.

<sup>2</sup>For proper SDRAM controller operation, the maximum load capacitance is 50 pF for ADDR, DATA,  $\overline{ABE3-0}/\overline{SDQM3-0}$ , CLKOUT/SCLK1, SCLK0, SCKE, SA10,  $\overline{SRAS}$ ,  $\overline{SCAS}$ ,  $\overline{SWE}$ , and  $\overline{SMS3-0}$ .

## ESD SENSITIVITY

### CAUTION

ESD (electrostatic discharge) sensitive device. Electrostatic charges as high as 4000 V readily accumulate on the human body and test equipment and can discharge without detection. Although the ADSP-BF535 features proprietary ESD protection circuitry, permanent damage may occur on devices subjected to high energy electrostatic discharges. Therefore, proper ESD precautions are recommended to avoid performance degradation or loss of functionality.



## TIMING SPECIFICATIONS

Table 9 and Table 10 describe the timing requirements for the ADSP-BF535 Blackfin processor clocks. Take care in selecting MSEL and SSEL ratios so as not to exceed the maximum core clock, system clock and Voltage Controlled Oscillator (VCO)

operating frequencies, as described in Absolute Maximum Ratings on Page 22. Table 10 describes phase-locked loop operating conditions.

**Table 9. Core Clock Requirements**

Parameter		Min	Max	Unit
t <sub>CCLK1.6</sub>	Core Cycle Period (V <sub>DDINT</sub> = 1.6 V–50 mV)	2.86	200	ns
t <sub>CCLK1.5</sub>	Core Cycle Period (V <sub>DDINT</sub> = 1.5 V–5%)	3.33	200	ns
t <sub>CCLK1.4</sub>	Core Cycle Period (V <sub>DDINT</sub> = 1.4 V–5%)	3.70	200	ns
t <sub>CCLK1.3</sub>	Core Cycle Period (V <sub>DDINT</sub> = 1.3 V–5%)	4.17	200	ns
t <sub>CCLK1.2</sub>	Core Cycle Period (V <sub>DDINT</sub> = 1.2 V–5%)	4.76	200	ns
t <sub>CCLK1.1</sub>	Core Cycle Period (V <sub>DDINT</sub> = 1.1 V–5%)	5.56	200	ns
t <sub>CCLK1.0</sub>	Core Cycle Period (V <sub>DDINT</sub> = 1.0 V–5%)	6.67	200	ns

**Table 10. Phase-Locked Loop Operating Conditions**

Parameter	Min	Nominal	Max	Unit
Operating Voltage	1.425	1.5	1.575	V
Jitter, Rising Edge to Rising Edge, Per Output <sup>1</sup>			120	ps
Jitter, Rising Edge to Falling Edge, Per Output <sup>1</sup>			60	ps
Skew, Rising Edge to Rising Edge, Any Two Outputs <sup>1</sup>			120	ps
Voltage Controlled Oscillator (VCO) Frequency <sup>1</sup>	40		400	MHz
V <sub>DDPLL</sub> Induced Jitter <sup>1</sup>			1	ps/mV

<sup>1</sup>Guaranteed but not tested.

# ADSP-BF535

## Clock and Reset Timing

Table 11 and Figure 8 describe clock and reset operations. Per ABSOLUTE MAXIMUM RATINGS on Page 22, combinations of CLKIN and clock multipliers must not select core and system clocks in excess of 350/300/200 MHz and 133 MHz, respectively.

Table 11. Clock and Reset Timing

Parameter	Min	Max	Unit
<i>Timing Requirements</i>			
$t_{CKIN}$ CLKIN Period	25.0	100.0	ns
$t_{CKINL}$ CLKIN Low Pulse <sup>1</sup>	10.0		ns
$t_{CKINH}$ CLKIN High Pulse <sup>1</sup>	10.0		ns
$t_{WRST}$ $\overline{RESET}$ Asserted Pulse Width Low <sup>2</sup>	$11 \times t_{CKIN}$		ns
$t_{MSD}$ Delay from $\overline{RESET}$ Asserted to MSELx, SSELx, BYPASS, and DF Valid <sup>3</sup>		15.0	ns
$t_{MSS}$ MSELx/SSELx/DF/BYPASS Stable Setup Before $\overline{RESET}$ Deasserted <sup>4</sup>	$2 \times t_{CKIN}$		ns
$t_{MSH}$ MSELx/SSELx/DF/BYPASS Stable Hold After $\overline{RESET}$ Deasserted	$2 \times t_{CKIN}$		ns
<i>Switching Characteristics</i>			
$t_{PFD}$ Flag Output Disable Time After $\overline{RESET}$ Asserted		15.0	ns

<sup>1</sup> Applies to Bypass mode and Non-bypass mode.

<sup>2</sup> Applies after power-up sequence is complete. At power-up, the processor's internal phase-locked loop requires no more than 2000 CLKIN cycles, while  $\overline{RESET}$  is asserted, assuming stable power supplies and CLKIN (not including start-up time of external clock oscillator).

<sup>3</sup> SSELx, MSELx and DF values can change from this point, but the values must be valid.

<sup>4</sup> SSELx, MSELx and DF values must be held from this time, until the hold time expires.

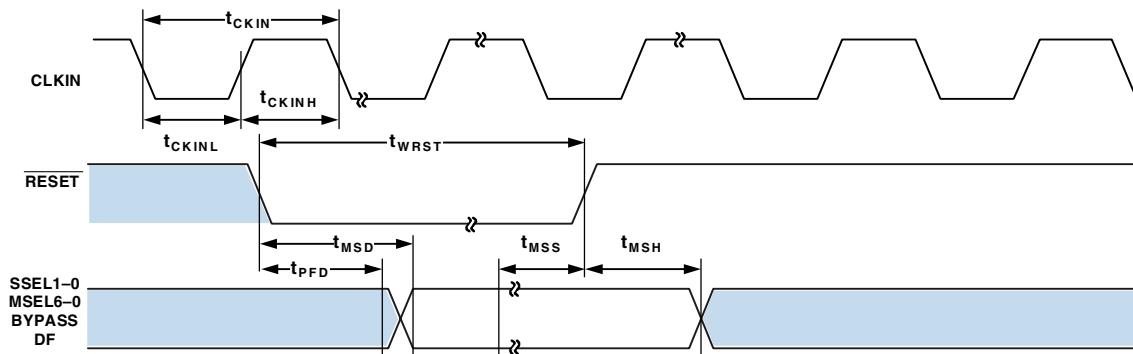

Figure 8. Clock and Reset Timing



**Programmable Flags Cycle Timing**

Table 12 and Figure 9 describe programmable flag operations.

**Table 12. Programmable Flags Cycle Timing**

Parameter		Min	Max	Unit
<i>Timing Requirements</i>				
$t_{HFIES}$	Edge Sensitive Flag Input Hold is Asynchronous	3.0		ns
$t_{HFILS}$	Level Sensitive Flag Input Hold	$t_{SCLK}+3$		ns
<i>Switching Characteristics</i>				
$t_{DFO}$	Flag Output Delay with Respect to SCLK		6.0	ns
$t_{HFO}$	Flag Output Hold After SCLK High		6.0	ns

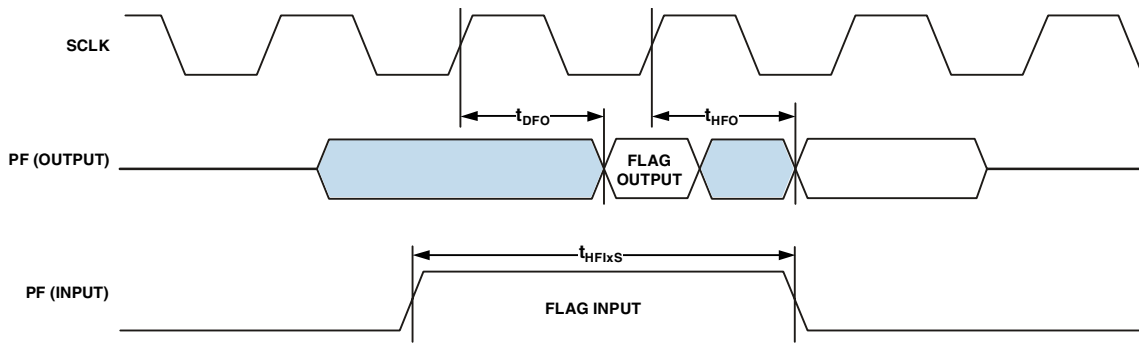

Figure 9. Programmable Flags Cycle Timing

# ADSP-BF535

## Timer PWM\_OUT Cycle Timing

Table 13 and Figure 10 describe timer expired operations. The input signal is asynchronous in “width capture mode” and has an absolute maximum input frequency of  $f_{SCLK} \div 2$ .

**Table 13. Timer PWM\_OUT Cycle Timing**

Parameter	Min	Max	Unit
<i>Switching Characteristics</i>			
$t_{HTO}$ Timer Pulse Width Output <sup>1</sup>	7.5	$(2^{32}-1)$ cycles	ns

<sup>1</sup>The minimum time for  $t_{HTO}$  is one cycle, and the maximum time for  $t_{HTO}$  equals  $(2^{32}-1)$  cycles.

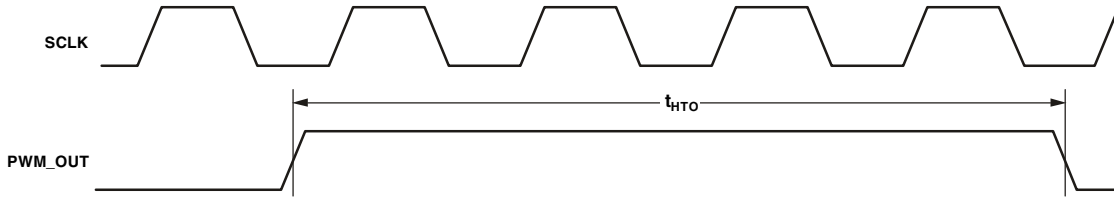

Figure 10. Timer PWM\_OUT Cycle Timing

## Asynchronous Memory Write Cycle Timing

Table 14 and Figure 11 describe Asynchronous Memory Write Cycle timing.

**Table 14. Asynchronous Memory Write Cycle Timing**

Parameter		Min	Max	Unit
<i>Timing Requirements</i>				
$t_{SARDY}$	ARDY Setup Before CLKOUT	4.0		ns
$t_{HARDY}$	ARDY Hold After CLKOUT	-1.0		ns
<i>Switching Characteristics</i>				
$t_{DDAT}$	DATA31-0 Disable After CLKOUT		6.0	ns
$t_{ENDAT}$	DATA31-0 Enable After CLKOUT	1.0		ns
$t_{DO}$	Output Delay After CLKOUT <sup>1</sup>		7.0	ns
$t_{HO}$	Output Hold After CLKOUT <sup>1</sup>	0.8		ns

<sup>1</sup> Output pins include  $\overline{AMS3-0}$ ,  $\overline{ABE3-0}$ , ADDR25-2, DATA31-0,  $\overline{AOE}$ ,  $\overline{AWE}$ .

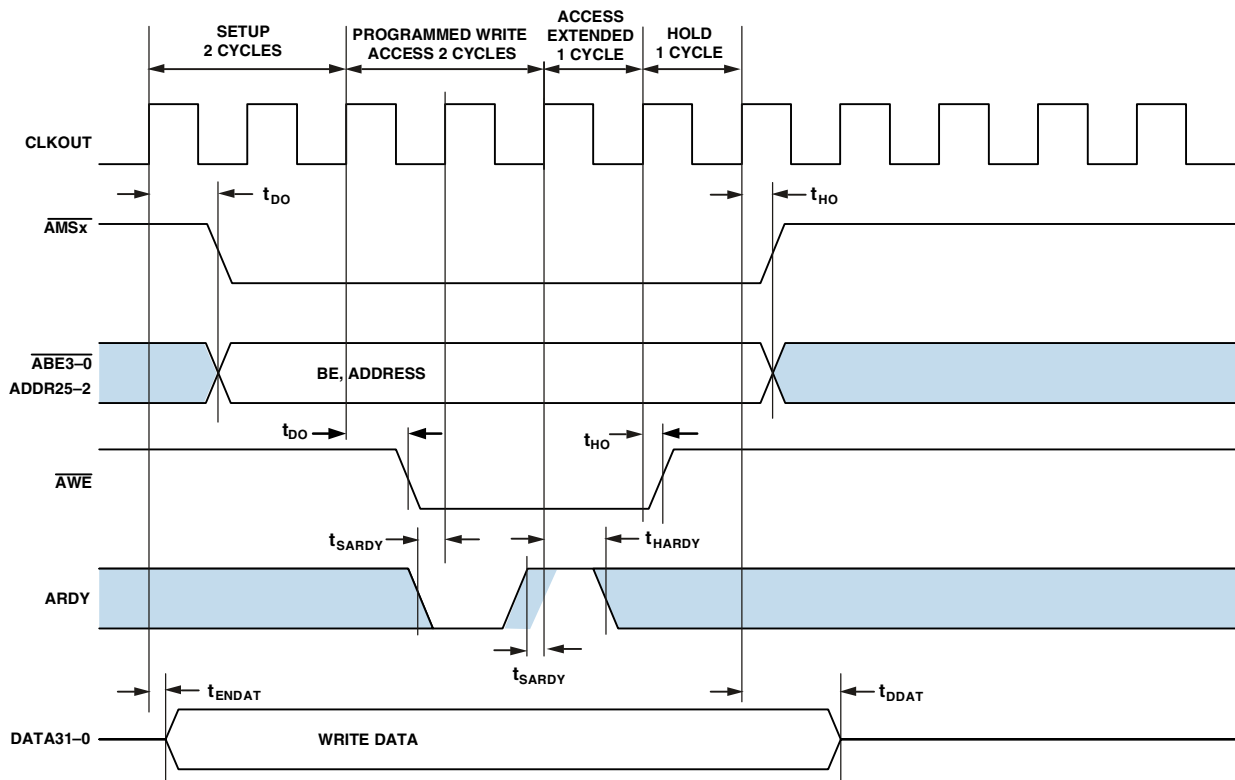

Figure 11. Asynchronous Memory Write Cycle Timing

# ADSP-BF535

## Asynchronous Memory Read Cycle Timing

Table 15 and Figure 12 describe Asynchronous Memory Read Cycle timing.

**Table 15. Asynchronous Memory Read Cycle Timing**

Parameter	Min	Max	Unit
<i>Timing Requirements</i>			
$t_{SDAT}$ DATA31-0 Setup Before CLKOUT	2.1		ns
$t_{HDAT}$ DATA31-0 Hold After CLKOUT	2.6		ns
$t_{SARDY}$ ARDY Setup Before CLKOUT	4.0		ns
$t_{HARDY}$ ARDY Hold After CLKOUT	-1.0		ns
<i>Switching Characteristics</i>			
$t_{DO}$ Output Delay After CLKOUT <sup>1</sup>		7.0	ns
$t_{HO}$ Output Hold After CLKOUT <sup>1</sup>	0.8		ns

<sup>1</sup> Output pins include AMS3-0, ABE3-0, ADDR25-2, AO $\bar{E}$ , AR $\bar{E}$ .

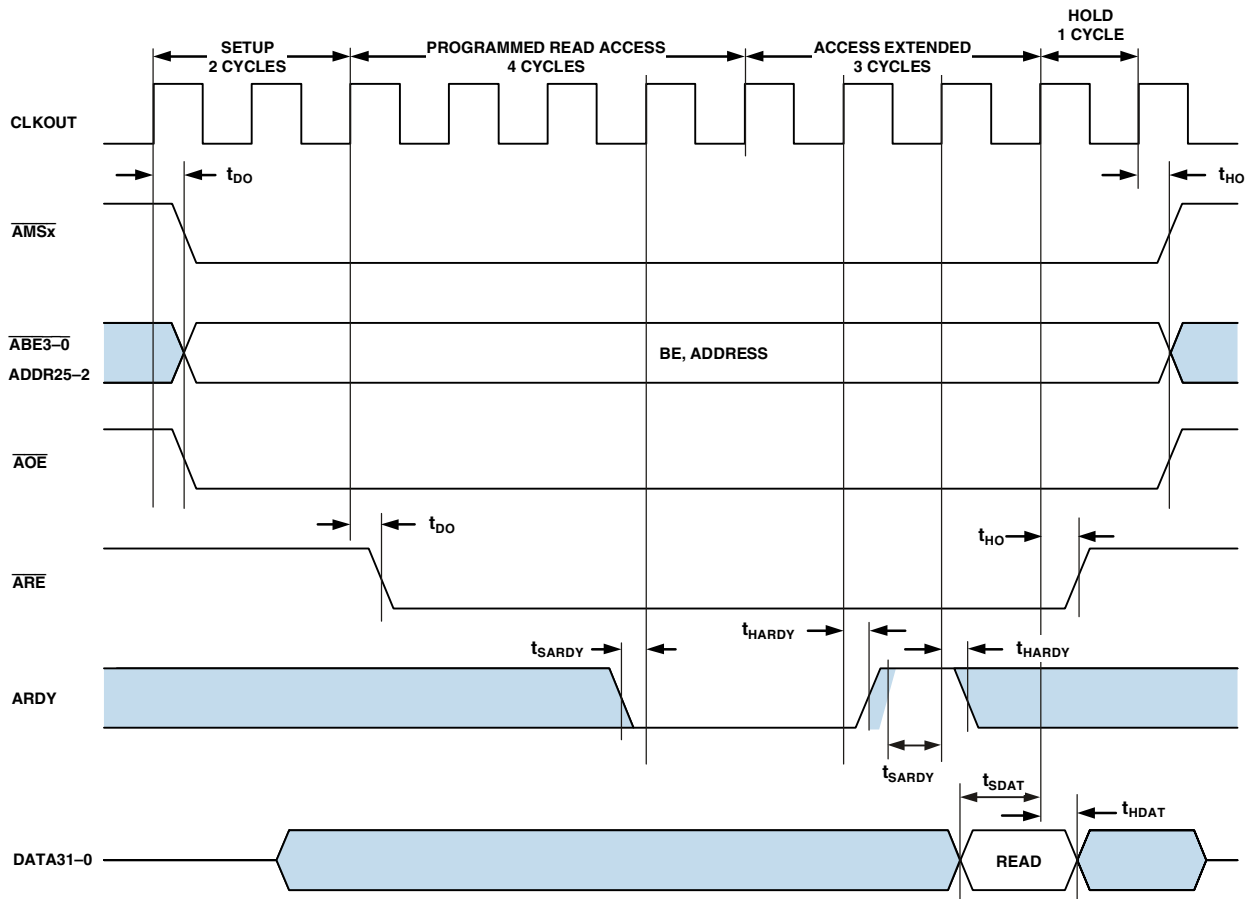

Figure 12. Asynchronous Memory Read Cycle Timing

## SDRAM Interface Timing

For proper SDRAM controller operation, the maximum load capacitance is 50 pF for ADDR, DATA,  $\overline{\text{ABE3-0}}$ / $\overline{\text{SDQM3-0}}$ ,  $\overline{\text{CLKOUT/SCLK1}}$ , SCLK0, SCKE, SA10, SRAS,  $\overline{\text{SCAS}}$ ,  $\overline{\text{SWE}}$ , and  $\overline{\text{SMS3-0}}$ .

**Table 16. SDRAM Interface Timing**

Parameter	Min	Max	Unit
<i>Timing Requirements</i>			
$t_{\text{SSDAT}}$ DATA Setup Before SCLK0/SCLK1	2.1		ns
$t_{\text{HSDAT}}$ DATA Hold After SCLK0/SCLK1	2.8		ns
<i>Switching Characteristics</i>			
$t_{\text{SCLK}}$ SCLK0/SCLK1 Period	7.5		ns
$t_{\text{SCLKH}}$ SCLK0/SCLK1 Width High	2.5		ns
$t_{\text{SCLKL}}$ SCLK0/SCLK1 Width Low	2.5		ns
$t_{\text{DCAD}}$ Command, ADDR, Data Delay After SCLK0/SCLK1 <sup>1</sup>		6.0	ns
$t_{\text{HCAD}}$ Command, ADDR, Data Hold After SCLK0/SCLK1 <sup>1</sup>	0.8		ns
$t_{\text{DSDAT}}$ Data Disable After SCLK0/SCLK1		6.0	ns
$t_{\text{ENSDAT}}$ Data Enable After SCLK0/SCLK1	1.0		ns

<sup>1</sup> Command pins include:  $\overline{\text{SRAS}}$ ,  $\overline{\text{SCAS}}$ ,  $\overline{\text{SWE}}$ ,  $\overline{\text{SDQM3-0}}$ ,  $\overline{\text{SMS}}$ , SA10, and SCKE.

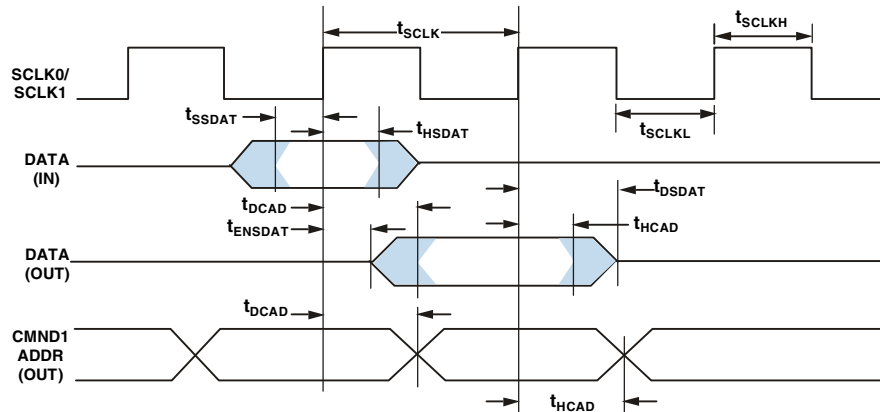

NOTE 1: COMMAND =  $\overline{\text{SRAS}}$ ,  $\overline{\text{SCAS}}$ ,  $\overline{\text{SWE}}$ ,  $\overline{\text{SDQM3-0}}$ ,  $\overline{\text{SMS}}$ , SA10, AND SCKE.

Figure 13. SDRAM Interface Timing

# ADSP-BF535

## Serial Ports

Table 17 through Table 22 and Figure 14 describe Serial Port timing.

**Table 17. Serial Ports—External Clock**

Parameter	Min	Max	Unit
<i>Timing Requirements</i>			
$t_{SFSE}$ TFS/RFS Setup Before TCLK/RCLK <sup>1</sup>	3.0		ns
$t_{HFSE}$ TFS/RFS Hold After TCLK/RCLK <sup>1</sup>	3.0		ns
$t_{SDRE}$ Receive Data Setup Before RCLK <sup>1</sup>	3.0		ns
$t_{HDRE}$ Receive Data Hold Before RCLK <sup>1</sup>	3.0		ns
$t_{SCLKWE}$ TCLK/RCLK Width	$(0.5 \times t_{SCLKE}) - 1$		ns
$t_{SCLKE}$ TCLK/RCLK Period	$2 \times t_{SCLK}$		ns

<sup>1</sup> Referenced to sample edge.

**Table 18. Serial Ports—Internal Clock**

Parameter	Min	Max	Unit
<i>Timing Requirements</i>			
$t_{SFSI}$ TFS/RFS Setup Before TCLK/RCLK <sup>1</sup>	7.0		ns
$t_{HFSI}$ TFS/RFS Hold After TCLK/RCLK <sup>1</sup>	2.0		ns
$t_{SDRI}$ Receive Data Setup Before RCLK <sup>1</sup>	7.0		ns
$t_{HDRI}$ Receive Data Hold Before RCLK <sup>1</sup>	4.0		ns

<sup>1</sup> Referenced to sample edge.

**Table 19. Serial Ports—External or Internal Clock**

Parameter	Min	Max	Unit
<i>Switching Characteristics</i>			
$t_{DFSE}$ RFS Delay After RCLK (Internally Generated RFS) <sup>1</sup>		10.0	ns
$t_{HOFSE}$ RFS Hold After RCLK (Internally Generated RFS) <sup>1</sup>	3.0		ns

<sup>1</sup> Referenced to drive edge.

**Table 20. Serial Ports—External Clock**

Parameter	Min	Max	Unit
<i>Switching Characteristics</i>			
$t_{DFSE}$ TFS Delay After TCLK (Internally Generated TFS) <sup>1</sup>		10.0	ns
$t_{HOFSE}$ TFS Hold After TCLK (Internally Generated TFS) <sup>1</sup>	3.0		ns
$t_{DDTE}$ Transmit Data Delay After TCLK <sup>1</sup>		10.0	ns
$t_{HDTE}$ Transmit Data Hold After TCLK <sup>1</sup>	3.0		ns

<sup>1</sup> Referenced to drive edge.

**Table 21. Serial Ports—Internal Clock**

Parameter	Min	Max	Unit
<i>Switching Characteristics</i>			
$t_{DFSI}$ TFS Delay After TCLK (Internally Generated TFS) <sup>1</sup>		6.0	ns
$t_{HOFSI}$ TFS Hold After TCLK (Internally Generated TFS) <sup>1</sup>	0.0		ns
$t_{DDTI}$ Transmit Data Delay After TCLK <sup>1</sup>		8.0	ns
$t_{HDTI}$ Transmit Data Hold After TCLK <sup>1</sup>	0.0		ns
$t_{SCLKWI}$ TCLK/RCLK Width	$0.5 \times t_{SCLK}$		ns

<sup>1</sup> Referenced to drive edge.

**Table 22. Serial Ports—Enable and Three-State (Multichannel Mode Only)**

Parameter		Min	Max	Unit
<i>Switching Characteristics</i>				
$t_{DTENE}$	Data Enable Delay from External TCLK <sup>1</sup>	3.0		ns
$t_{DDTTE}$	Data Disable Delay from External TCLK <sup>1</sup>		12.0	ns
$t_{DTENI}$	Data Enable Delay from Internal TCLK <sup>1</sup>	2.0		ns
$t_{DDTTI}$	Data Disable Delay from Internal TCLK <sup>1</sup>		12.0	ns

<sup>1</sup> Referenced to drive edge and TCLK is tied to RCLK.

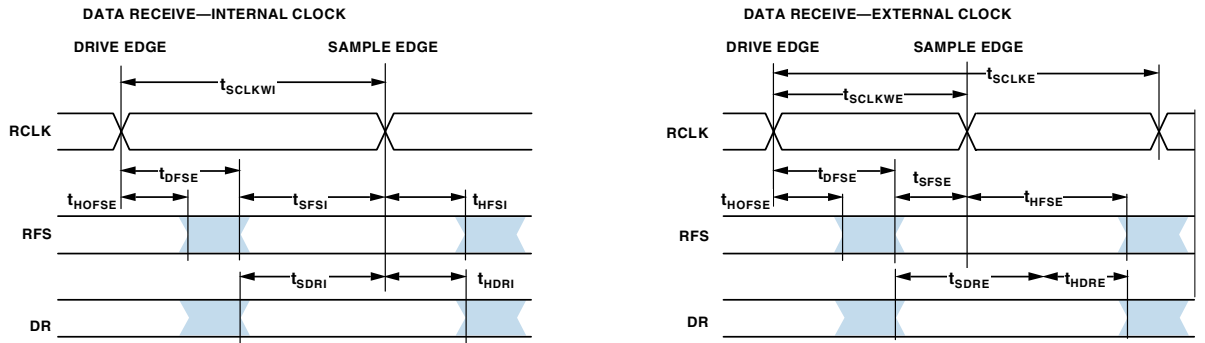

NOTE: EITHER THE RISING EDGE OR FALLING EDGE OF RCLK OR TCLK CAN BE USED AS THE ACTIVE SAMPLING EDGE.

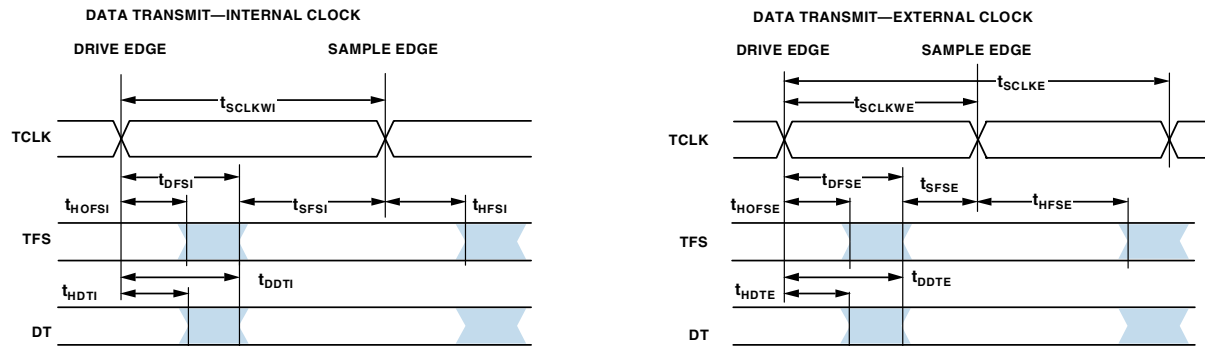

NOTE: EITHER THE RISING EDGE OR FALLING EDGE OF RCLK OR TCLK CAN BE USED AS THE ACTIVE SAMPLING EDGE.

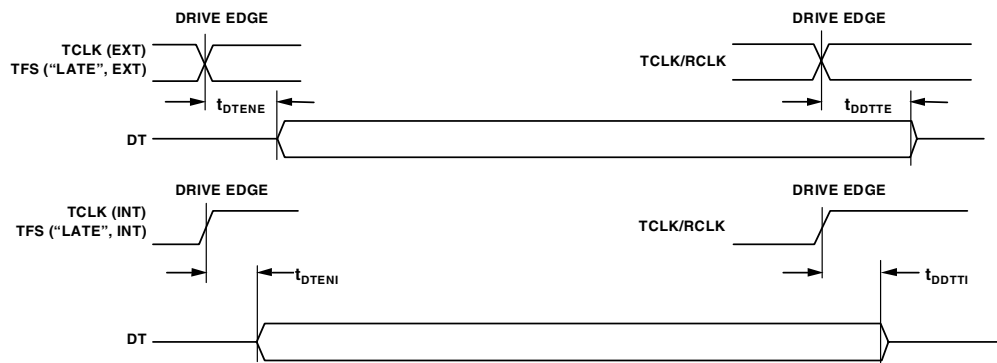

Figure 14. Serial Ports

# ADSP-BF535

## Serial Peripheral Interface (SPI) Port —Master Timing

Table 23 and Figure 15 describe SPI port master operations.

**Table 23. Serial Peripheral Interface (SPI) Port—Master Timing**

Parameter	Min	Max	Unit
<i>Timing Requirements</i>			
$t_{SSPID}$	Data Input Valid to SCK Edge (Data Input Setup)		ns
$t_{HSPID}$	SCK Sampling Edge to Data Input Invalid		ns
<i>Switching Characteristics</i>			
$t_{SDSCIM}$	$\overline{SPIxSEL}$ Low to First SCK Edge ( $x=0$ or $1$ )		ns
$t_{SPICHM}$	Serial Clock High Period		ns
$t_{SPICLM}$	Serial Clock Low Period		ns
$t_{SPICLK}$	Serial Clock Period		ns
$t_{HDSM}$	Last SCK Edge to $\overline{SPIxSEL}$ High ( $x=0$ or $1$ )		ns
$t_{SPITDM}$	Sequential Transfer Delay		ns
$t_{DDSPID}$	SCK Edge to Data Out Valid (Data Out Delay)		ns
$t_{HDSPID}$	SCK Edge to Data Out Invalid (Data Out Hold)		ns

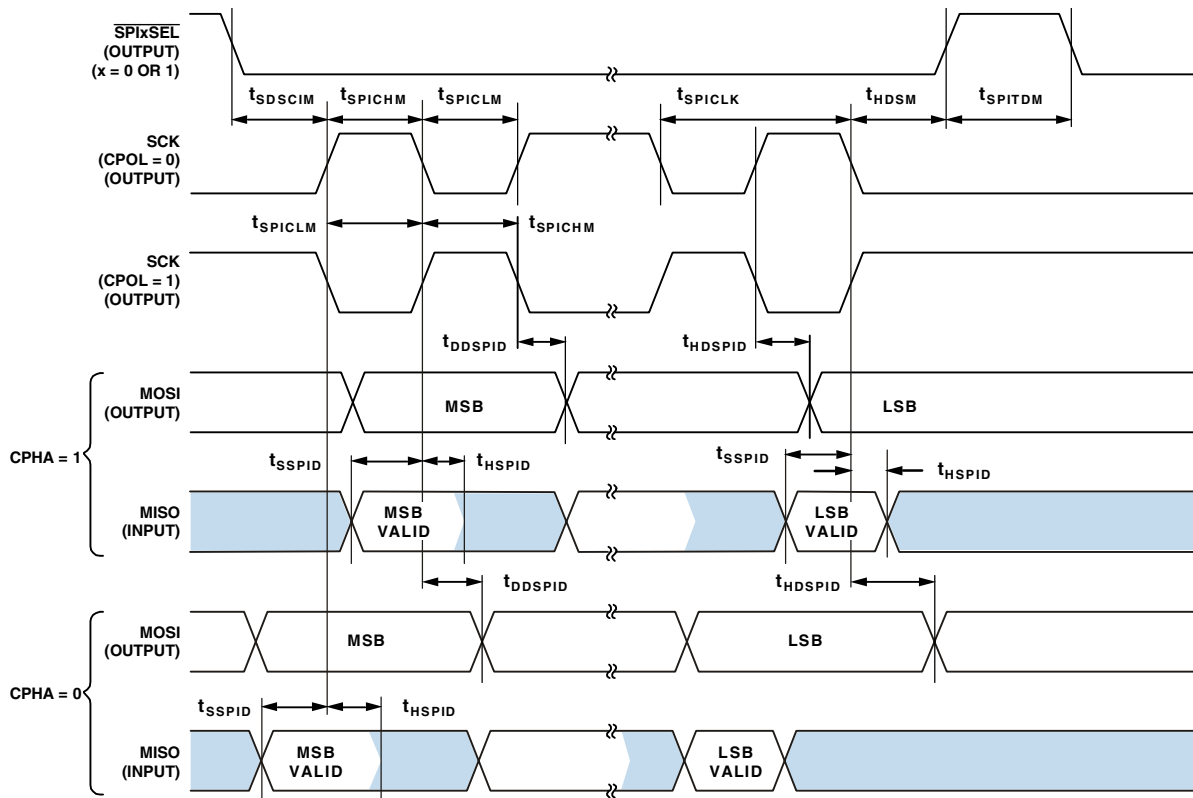

Figure 15. Serial Peripheral Interface (SPI) Port—Master Timing



**Serial Peripheral Interface (SPI) Port  
—Slave Timing**

Table 24 and Figure 16 describe SPI port slave operations.

**Table 24. Serial Peripheral Interface (SPI) Port—Slave Timing**

Parameter		Min	Max	Unit
<i>Timing Requirements</i>				
$t_{SPICHS}$	Serial Clock High Period	$2t_{SCLK}$		ns
$t_{SPICLS}$	Serial Clock Low Period	$2t_{SCLK}$		ns
$t_{SPICLK}$	Serial Clock Period	$4t_{SCLK}$		ns
$t_{HDS}$	Last SPICLK Edge to $\overline{SPISS}$ Not Asserted	$2t_{SCLK}$		ns
$t_{SPITDS}$	Sequential Transfer Delay	$2t_{SCLK}$		ns
$t_{SDSCI}$	$\overline{SPISS}$ Assertion to First SCK Edge	$2t_{SCLK}$		ns
$t_{SSPID}$	Data Input Valid to SCK Edge (Data Input Setup)	1.6		ns
$t_{HSPID}$	SCK Sampling Edge to Data Input Invalid	1.6		ns
<i>Switching Characteristics</i>				
$t_{DSOE}$	$\overline{SPISS}$ Assertion to Data Out Active	0.0	6.0	ns
$t_{DSDHI}$	$\overline{SPISS}$ Deassertion to Data High Impedance	0.0	6.5	ns
$t_{DDSPID}$	SCK Edge to Data Out Valid (Data Out Delay)	0.0	7.0	ns
$t_{HDSPID}$	SCK Edge to Data Out Invalid (Data Out Hold)	0.0	6.5	ns

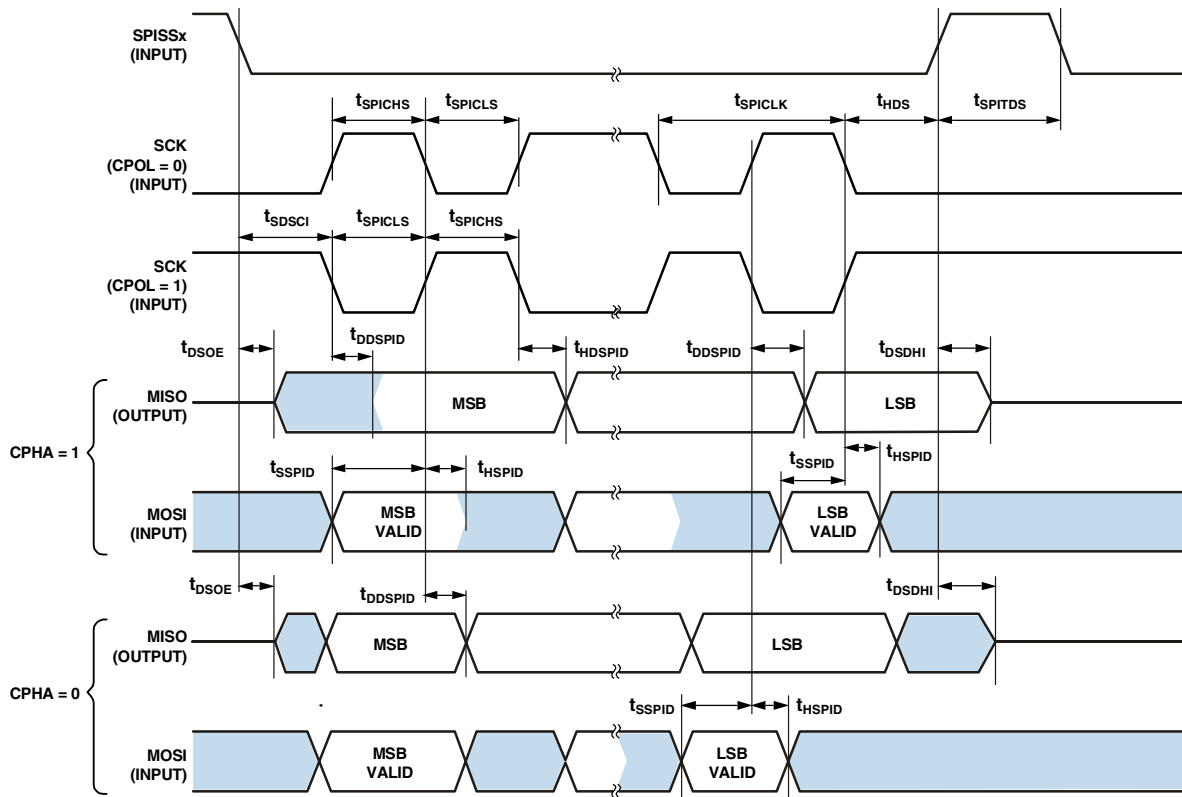

Figure 16. Serial Peripheral Interface (SPI) Port—Slave Timing

# ADSP-BF535

## Universal Asynchronous Receiver-Transmitter (UART) Port—Receive and Transmit Timing

Figure 17 describes UART port receive and transmit operations. The maximum baud rate is  $SCLK/16$ . As shown in Figure 17, there is some latency between the generation of internal UART interrupts and the external data operations. These latencies are negligible at the data transmission rates for the UART.

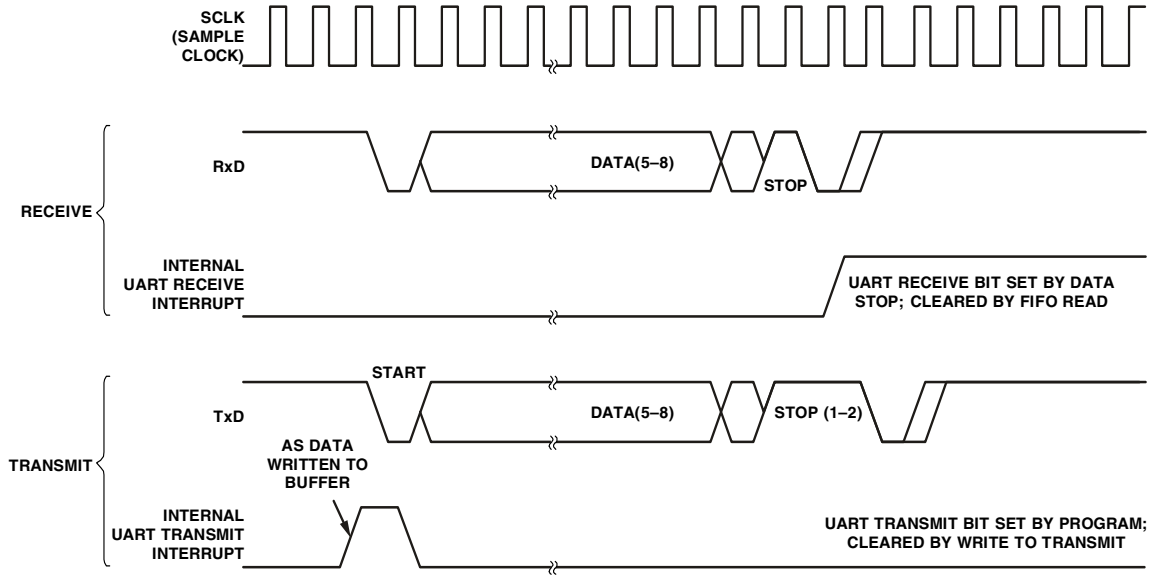

Figure 17. UART Port—Receive and Transmit Timing

## JTAG Test and Emulation Port Timing

Table 25 and Figure 18 describe JTAG port operations.

**Table 25. JTAG Port Timing**

Parameter	Min	Max	Unit
<i>Timing Requirements</i>			
$t_{TCK}$ TCK Period	20.0		ns
$t_{STAP}$ TDI, TMS Setup Before TCK High		4.0	ns
$t_{HTAP}$ TDI, TMS Hold After TCK High		4.0	ns
$t_{SSYS}$ System Inputs Setup Before TCK Low <sup>1</sup>		4.0	ns
$t_{HSYS}$ System Inputs Hold After TCK Low <sup>1</sup>		5.0	ns
$t_{TRSTW}$ $\overline{TRST}$ Pulse Width <sup>2</sup>	4.0		ns
<i>Switching Characteristics</i>			
$t_{DTDO}$ TDO Delay from TCK Low		7.0	ns
$t_{DSYS}$ System Outputs Delay After TCK Low <sup>3</sup>	0.0	15.0	ns

<sup>1</sup> System Inputs=DATA31-0, ADDR25-2, ARDY, TMR2-0, PF15-0, RSCLK0, RFS0, DR0, TSCLK0, TFS0, RSCLK1, RFS1, DR1, TSCLK1, TFS1, MOSI0, MISO0, SCK0, MOSI1, MISO1, SCK1, RX0, RX1, USB\_CLK, XVER\_DATA, DPLS, DMNS, NMI,  $\overline{RESET}$ , BYPASS, BMODE2-0, PCI\_AD31-0, PCI\_CBE3-0, PCI\_FRAME, PCI\_IRDY, PCI\_TRDY, PCI\_DEVSEL, PCI\_STOP, PCI\_PERR, PCI\_PAR, PCI\_SERR, PCI\_RST, PCI\_GNT, PCI\_IDSEL,  $\overline{PCI\_LOCK}$ , PCI\_CLK,  $\overline{PCI\_INTA}$ ,  $\overline{PCI\_INTB}$ ,  $\overline{PCI\_INTC}$ ,  $\overline{PCI\_INTD}$ .

<sup>2</sup> 50 MHz max.

<sup>3</sup> System Outputs=DATA31-0, ADDR25-2,  $\overline{ABE3-0/SDQM3-0}$ ,  $\overline{AOE}$ ,  $\overline{ARE}$ ,  $\overline{AWE}$ ,  $\overline{SCAS}$ , CLKOUT/SCLK1, SCLK0, SCKE, SA10,  $\overline{SWE}$ ,  $\overline{SMS3-0}$ ,  $\overline{SRAS}$ , TMR2-0, PF15-0, RSCLK0, RFS0, TSCLK0, TFS0, DT0, RSCLK1, RFS1, TSCLK1, TFS1, DT1, MOSI0, MISO0, SCK0, MOSI1, MISO1, SCK1, TX0, TX1, TXDPLS, TXDMNS,  $\overline{TXEN}$ , SUSPEND, DEEPSLEEP, PCI\_AD31-0, PCI\_CBE3-0, PCI\_FRAME, PCI\_IRDY, PCI\_TRDY, PCI\_DEVSEL, PCI\_STOP, PCI\_PERR, PCI\_PAR, PCI\_REQ, PCI\_SERR, PCI\_RST,  $\overline{PCI\_INTA}$ , EMU.

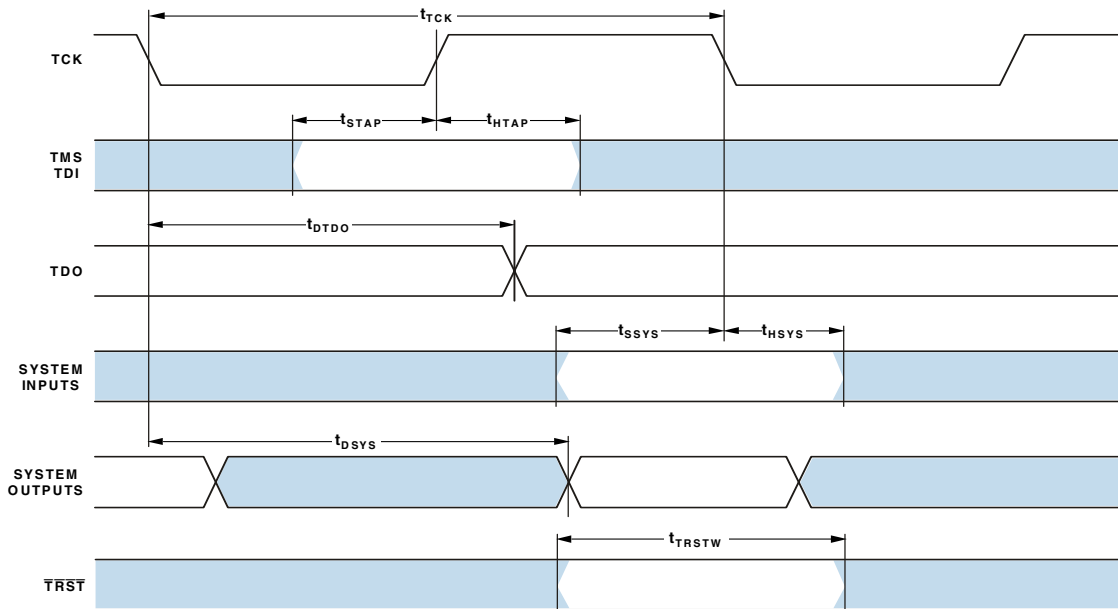

Figure 18. JTAG Port Timing

# ADSP-BF535

## Output Drive Currents

Figure 19 through Figure 21 show typical current-voltage characteristics for the output drivers of the ADSP-BF535 Blackfin processor. The curves represent the current drive capability of the output drivers as a function of output voltage. Figure 19 applies to the ABE3-0, SDQM3-0, ADDR25-2, AMS3-0, AOE, ARE, AWE, CLKOUT, SCLK1, DATA31-0, DT1-0, EMU, MISO1-0, MOSI1-0, PF15-0, RFS1-0, RSCLK1-0, SA10, SCAS, SCK1-0, SCKE, SCLK0, DEEPSLEEP, SMS3-0, SRAS, SUSPEND, SWE, TDO, TFS1-0, TMR2-0, TSCLK1-0, TX1-0, TXDMNS, TXDPLS, TXEN, and XTAL0 pins. Figure 20 applies to the PCI\_AD31-0, PCI\_CBE3-0, PCI\_DEVSEL, PCI\_FRAME, PCI\_INTA, PCI\_IRDY, PCI\_PAR, PCI\_PERR, PCI\_RST, PCI\_SERR, PCI\_STOP, and PCI\_TRDY pins. Figure 21 applies to the PCI\_REQ pin.

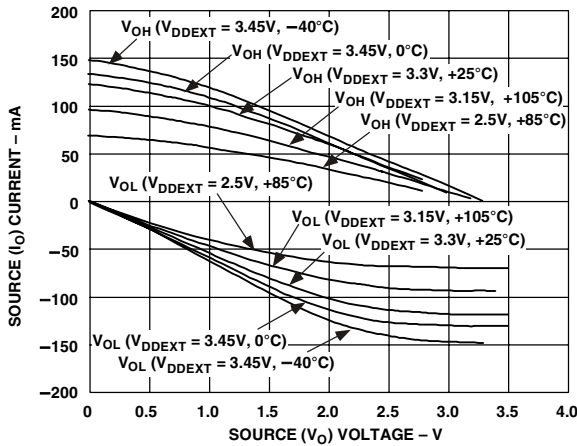

Figure 19. Output Drive Current

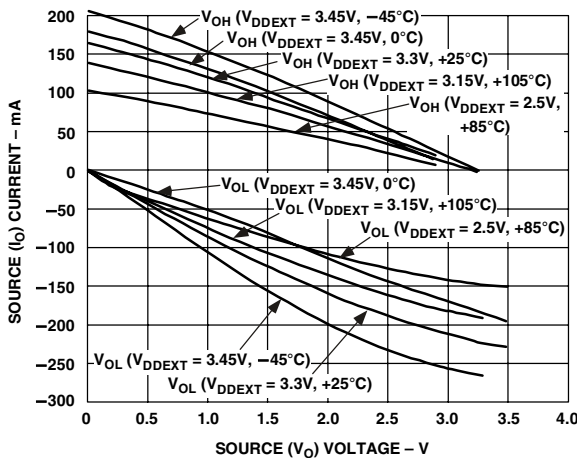

Figure 20. PCI 33 MHz Output Drive Current

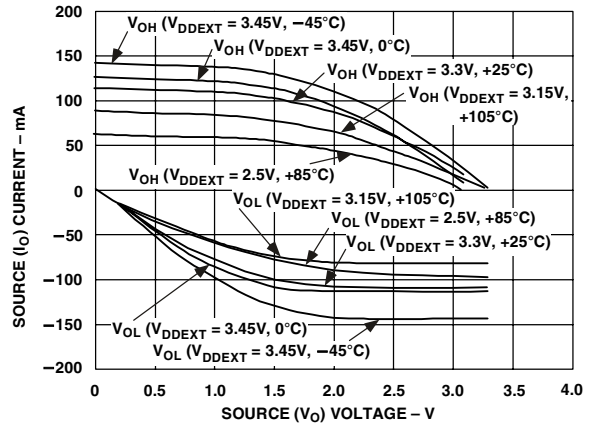

Figure 21. PCI\_REQ Output Drive Current

## Power Dissipation

Total power dissipation has two components: one due to internal circuitry ( $P_{INT}$ ) and one due to the switching of external output drivers ( $P_{EXT}$ ). Table 26 shows the power dissipation for internal circuitry ( $V_{DDINT}$ ). Internal power dissipation is dependent on the instruction execution sequence and the data operands involved. Table 27 shows the power dissipation for the phase-locked loop (PLL) circuitry ( $V_{DDPLL}$ ).

The external component of total power dissipation is caused by the switching of output pins. Its magnitude depends on:

- Maximum frequency ( $f_0$ ) at which all output pins can switch during each cycle
- Their load capacitance ( $C_0$ ) of all switching pins
- Their voltage swing ( $V_{DDEXT}$ )

The external component is calculated using:

$$P_{EXT} = V_{DDEXT}^2 \times \sum C_0 \times f_0$$

Table 26. Internal Power Dissipation

Parameter	Test Conditions <sup>1</sup>				Unit
	$f_{CCLK} = 100 \text{ MHz}$	$f_{CCLK} = 200 \text{ MHz}$	$f_{CCLK} = 300 \text{ MHz}$	$f_{CCLK} = 350 \text{ MHz}$	
$I_{DDTYP}$ <sup>2</sup>	96.0	206.0	387.0	498.0	mA
$I_{DDFR}$ <sup>3</sup>	114.0	248.0	463.0	579.0	mA
$I_{DDSLEEP}$ <sup>4</sup>	15.0	29.0	52.0	62.0	mA
$I_{DDDEEPSLEEP}$ <sup>4</sup>	4.0	5.0	8.2	9.8	mA
$I_{DDRESET}$ <sup>5</sup>	132.0	255.0	485.3	651.0	mA

<sup>1</sup>  $I_{DD}$  data is specified for typical process parameters. All data at 25°C.

<sup>2</sup> Processor executing 75% dual Mac, 25% ADD with moderate data bus activity.

<sup>3</sup> Implementation of Enhanced Full Rate (EFR) GSM algorithm.

<sup>4</sup> See the *ADSP-BF535 Blackfin Processor Hardware Reference Manual* for definitions of Sleep and Deep Sleep operating modes.

<sup>5</sup>  $I_{DD}$  is specified for when the device is in the reset state.

**Table 27. PLL Power Dissipation**

Parameter	Test Conditions	Typical	Unit
$I_{DDPLL}$	$V_{DDPLL} = 1.5\text{ V}$ , $25^\circ\text{C}$	4.0	mA

The frequency  $f$  includes driving the load high and then back low. For example: DATA31–0 pins can drive high and low at a maximum rate of  $1/(2 \times t_{SCLK})$  while in SDRAM burst mode.

A typical power consumption can now be calculated for these conditions by adding a typical internal power dissipation:

$$P_{TOTAL} = P_{EXT} + (I_{DD} \times V_{DDINT})$$

Note that the conditions causing a worst-case  $P_{EXT}$  differ from those causing a worst-case  $P_{INT}$ . Maximum  $P_{INT}$  cannot occur while 100% of the output pins are switching from all ones (1s) to all zeros (0s). Note, as well, that it is not common for an application to have 100% or even 50% of the outputs switching simultaneously.

**Test Conditions**

All timing parameters appearing in this data sheet were measured under the conditions described in this section.

**Output Enable Time**

Output pins are considered to be enabled when they have made a transition from a high impedance state to the point when they start driving. The output enable time  $t_{ENA}$  is the interval from the point when a reference signal reaches a high or low voltage level to the point when the output starts driving as shown in the Output Enable/Disable diagram (Figure 22). The time  $t_{ENA\_MEASURED}$  is the interval from when the reference signal switches to when the output voltage reaches 2.0 V (output high) or 1.0 V (output low). Time  $t_{TRIP}$  is the interval from when the output starts driving to when the output reaches the 1.0 V or 2.0 V trip voltage. Time  $t_{ENA}$  is calculated as shown in the equation:

$$t_{ENA} = t_{ENA\_MEASURED} - t_{TRIP}$$

If multiple pins (such as the data bus) are enabled, the measurement value is that of the first pin to start driving.

**Output Disable Time**

Output pins are considered to be disabled when they stop driving, go into a high impedance state, and start to decay from their output high or low voltage. The time for the voltage on the bus to decay by  $\Delta V$  is dependent on the capacitive load,  $C_L$  and the load current,  $I_L$ . This decay time can be approximated by the equation:

$$t_{DECAY} = (C_L \Delta V) / I_L$$

The output disable time  $t_{DIS}$  is the difference between  $t_{DIS\_MEASURED}$  and  $t_{DECAY}$  as shown in Figure 22. The time  $t_{DIS\_MEASURED}$  is the interval from when the reference signal switches to when the output voltage decays  $\Delta V$  from the measured output high or output low voltage. The time  $t_{DECAY}$  is calculated with test loads  $C_L$  and  $I_L$ , and with  $\Delta V$  equal to 0.5 V.

**Example System Hold Time Calculation**

To determine the data output hold time in a particular system, first calculate  $t_{DECAY}$  using the equation given above. Choose  $\Delta V$  to be the difference between the ADSP-BF535 Blackfin processor's output voltage and the input threshold for the device requiring the hold time. A typical  $\Delta V$  will be 0.4 V.  $C_L$  is the total bus capacitance (per data line), and  $I_L$  is the total leakage or three-state current (per data line). The hold time will be  $t_{DECAY}$  plus the minimum disable time (for example,  $t_{DSDAT}$  for an SDRAM write cycle).

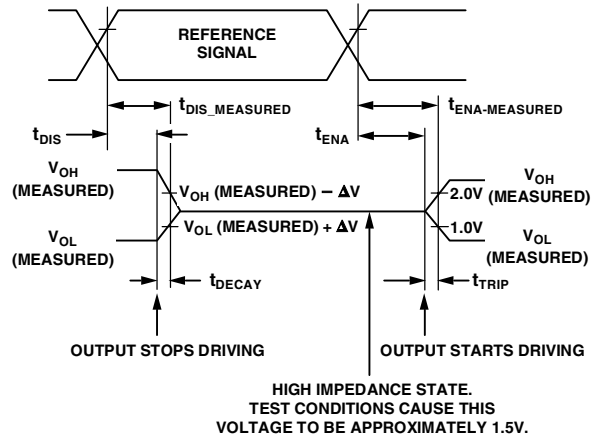

Figure 22. Output Enable/Disable

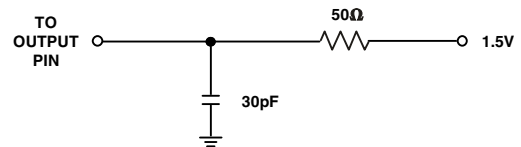

Figure 23. Equivalent Device Loading for AC Measurements (Includes All Fixtures)

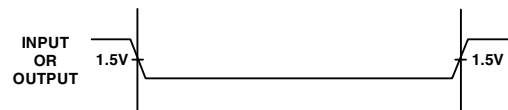

Figure 24. Voltage Reference Levels for AC Measurements (Except Output Enable/Disable)

# ADSP-BF535

## Environmental Conditions

The ADSP-BF535 is offered in a 260-ball PBGA package.

To determine the junction temperature on the application printed circuit board use:

$$T_J = T_{CASE} + (\Psi_{JT} \times P_D)$$

where:

$T_J$  = Junction temperature (°C)

$T_{CASE}$  = Case temperature (°C) measured by customer at top center of package.

$\Psi_{JT}$  = From [Table 28](#)

$P_D$  = Power dissipation (see [Power Dissipation on Page 36](#) for the method to calculate  $P_D$ )

Values of  $\theta_{JA}$  are provided for package comparison and printed circuit board design considerations.  $\theta_{JA}$  can be used for a first order approximation of  $T_J$  by the equation:

$$T_J = T_A + (\theta_{JA} \times P_D)$$

where:

$T_A$  = Ambient temperature (°C)

Values of  $\theta_{JC}$  are provided for package comparison and printed circuit board design considerations when an external heatsink is required.

Values of  $\theta_{JB}$  are provided for package comparison and printed circuit board design considerations.

In [Table 28](#), airflow measurements comply with JEDEC standards JESD51-2 and JESD51-6, and the junction-to-board measurement complies with JESD51-8. The junction-to-case measurement complies with MIL-STD-883 (Method 1012.1). All measurements use a 2S2P JEDEC test board.

**Table 28. Thermal Characteristics**

Parameter	Condition	Typical	Unit
$\theta_{JA}$	0 linear m/s air flow	23.8	°C/W
$\theta_{JMA}$	1 linear m/s air flow	20.8	°C/W
$\theta_{JMA}$	2 linear m/s air flow	19.8	°C/W
$\theta_{JB}$		9.95	°C/W
$\theta_{JC}$		9.35	°C/W
$\Psi_{JT}$	0 linear m/s air flow	0.30	°C/W

## 260-Ball PBGA Pinout

Table 29 lists the PBGA pinout by signal name. Table 30 on

Page 41 lists the pinout by pin number.

**Table 29. 260-Ball PBGA Pin Assignment (Alphabetically by Signal)**

Signal	Pin	Signal	Pin	Signal	Pin	Signal	Pin
$\overline{ABE0}/SDQM0$	E02	DATA5	R02	GND	K08	PCI_AD25	M16
$\overline{ABE1}/SDQM1$	B01	DATA6	P03	GND	K09	PCI_AD26	N17
$\overline{ABE2}/SDQM2$	G03	DATA7	U01	GND	K10	PCI_AD27	P17
$\overline{ABE3}/SDQM3$	H07	DATA8	U02	GND	K11	PCI_AD28	P15
ADDR2	A06	DATA9	T02	GND	K12	PCI_AD29	N16
ADDR3	B06	DATA10	V02	GND	L07	PCI_AD30	R17
ADDR4	D06	DATA11	V03	GND	L08	PCI_AD31	P16
ADDR5	C06	DATA12	R04	GND	L09	$\overline{PCI\_CBE0}$	F16
ADDR6	A05	DATA13	U03	GND	L10	$\overline{PCI\_CBE1}$	F15
ADDR7	B05	DATA14	T03	GND	L11	$\overline{PCI\_CBE2}$	E16
ADDR8	A04	DATA15	T04	GND	M07	$\overline{PCI\_CBE3}$	D17
ADDR9	C05	DATA16	U04	GND	M09	PCI_CLK	D14
ADDR10	D05	DATA17	V04	GND	M10	$\overline{PCI\_DEVSEL}$	C16
ADDR11	B04	DATA18	V05	MISO0	T16	$\overline{PCI\_FRAME}$	C17
ADDR12	A01	DATA19	R05	MISO1	U18	$\overline{PCI\_GNT}$	C18
ADDR13	C04	DATA20	T05	MOSI0	U16	PCI_IDSEL	B18
ADDR14	D04	DATA21	U05	MOSI1	T17	$\overline{PCI\_INTA}$	C14
ADDR15	A03	DATA22	V06	N/C	A18	$\overline{PCI\_INTB}$	B15
ADDR16	B03	DATA23	R06	N/C	R03	$\overline{PCI\_INTC}$	A15
ADDR17	A02	DATA24	U06	N/C	V01	$\overline{PCI\_INTD}$	D13
ADDR18	C03	DATA25	T06	N/C	V18	$\overline{PCI\_IRDY}$	E15
ADDR19	D03	DATA26	V07	NMI	B11	$\overline{PCI\_LOCK}$	A16
ADDR20	B02	DATA27	V08	PCI_AD0	E17	PCI_PAR	C15
ADDR21	C02	DATA28	U07	PCI_AD1	E18	$\overline{PCI\_PERR}$	D15
ADDR22	E03	DATA29	R07	PCI_AD2	G16	$\overline{PCI\_REQ}$	D16
ADDR23	C01	DATA30	T07	PCI_AD3	F17	$\overline{PCI\_RST}$	D18
ADDR24	F03	DATA31	V09	PCI_AD4	F18	$\overline{PCI\_SERR}$	B16
ADDR25	D02	DMNS	D08	PCI_AD5	G18	$\overline{PCI\_STOP}$	A17
$\overline{AMS0}$	F02	DPLS	C09	PCI_AD6	G17	$\overline{PCI\_TRDY}$	B17
$\overline{AMS1}$	D01	DR0	V14	PCI_AD7	H18	PF0/SPISS0/MSEL0	U08
$\overline{AMS2}$	H03	DR1	U15	PCI_AD8	J18	PF1/SPISS1/MSEL1	R08
$\overline{AMS3}$	G02	DT0	R14	PCI_AD9	H17	PF2/SPI0SEL1/MSEL2	T08
$\overline{AOE}$	E01	DT1	V17	PCI_AD10	K18	PF3/SPI1SEL1/MSEL3	V10
ARDY	R01	$\overline{EMU}$	A13	PCI_AD11	H16	PF4/SPI0SEL2/MSEL4	U09
$\overline{ARE}$	F01	GND	C13	PCI_AD12	L18	PF5/SPI1SEL2/MSEL5	R09
$\overline{AWE}$	G01	GND	H02	PCI_AD13	J17	PF6/SPI0SEL3/MSEL6	T09
BMODE0	B14	GND	H08	PCI_AD14	M18	PF7/SPI1SEL3/DF	R11
BMODE1	A14	GND	H10	PCI_AD15	K17	PF8/SPI0SEL4/SSEL0	T11
BMODE2	B13	GND	H11	PCI_AD16	J16	PF9/SPI1SEL4/SSEL1	U11
BYPASS	C12	GND	J07	PCI_AD17	K16	PF10/SPI0SEL5	V12
CLKIN1	D09	GND	J08	PCI_AD18	N18	PF11/SPI1SEL5	T12
CLKOUT/SCLK1	H01	GND	J09	PCI_AD19	P18	PF12/SPI0SEL6	R12
DATA0	N02	GND	J10	PCI_AD20	L17	PF13/SPI1SEL6	U12
DATA1	M03	GND	J11	PCI_AD21	L16	PF14/SPI0SEL7	V13
DATA2	T01	GND	J12	PCI_AD22	R18	PF15/SPI1SEL7	T13
DATA3	P02	GND	K02	PCI_AD23	T18	$\overline{RESET}$	B09
DATA4	N03	GND	K07	PCI_AD24	M17	RFS0	U13

# ADSP-BF535

Table 29. 260-Ball PBGA Pin Assignment (Alphabetically by Signal) (continued)

Signal	Pin	Signal	Pin	Signal	Pin	Signal	Pin
RFS1	V16	$\overline{\text{SWE}}$	J03	USB_CLK	G07	V <sub>DDINT</sub>	L12
RSCLK0	R13	TCK	D10	V <sub>DDEXT</sub>	E04	V <sub>DDINT</sub>	M08
RSCLK1	U14	TDI	C11	V <sub>DDEXT</sub>	G04	V <sub>DDINT</sub>	M11
RX0	A07	TDO	D11	V <sub>DDEXT</sub>	G08	V <sub>DDINT</sub>	M12
RX1	B08	TFS0	T14	V <sub>DDEXT</sub>	J01	V <sub>DDINT</sub>	N04
SA10	M01	TFS1	R15	V <sub>DDEXT</sub>	J02	V <sub>DDINT</sub>	N15
$\overline{\text{SCAS}}$	L03	TMR0	B07	V <sub>DDEXT</sub>	J04	V <sub>DDPCIEXT</sub>	H15
SCK0	U17	TMR1	C07	V <sub>DDEXT</sub>	K04	V <sub>DDPCIEXT</sub>	J15
SCK1	R16	TMR2	D07	V <sub>DDEXT</sub>	L04	V <sub>DDPCIEXT</sub>	K15
SCKE	L01	TMS	A12	V <sub>DDEXT</sub>	M04	V <sub>DDPCIEXT</sub>	L15
SCLK0	K01	$\overline{\text{TRST}}$	B12	V <sub>DDEXT</sub>	P04	V <sub>DDPCIEXT</sub>	M15
DEEPSLEEP	D12	TSCLK0	V15	V <sub>DDINT</sub>	F04	V <sub>DDPLL</sub>	G09
$\overline{\text{SMS0}}$	M02	TSCLK1	T15	V <sub>DDINT</sub>	G11	V <sub>DDRTC</sub>	U10
$\overline{\text{SMS1}}$	P01	TX0	A08	V <sub>DDINT</sub>	G12	V <sub>SSPLL</sub>	A10
$\overline{\text{SMS2}}$	N01	TX1	C08	V <sub>DDINT</sub>	G15	V <sub>SSRTC</sub>	V11
$\overline{\text{SMS3}}$	K03	TXDMNS	G10	V <sub>DDINT</sub>	H04	XTAL1	R10
$\overline{\text{SRAS}}$	L02	TXDPLS	B10	V <sub>DDINT</sub>	H09	XTAL0	T10
SUSPEND	A11	$\overline{\text{TXEN}}$	C10	V <sub>DDINT</sub>	H12	XVER_DATA	A09



**Table 30. 260-Ball PBGA Pin Assignment (Numerically by Pin Number)**

Pin	Signal	Pin	Signal	Pin	Signal	Pin	Signal
A01	ADDR12	D12	DEEPSLEEP	K01	SCLK0	R08	PF1/ $\overline{\text{SPISS1}}$ /MSEL1
A02	ADDR17	D13	$\overline{\text{PCI\_INTD}}$	K02	GND	R09	PF5/ $\overline{\text{SPI1SEL2}}$ /MSEL5
A03	ADDR15	D14	$\overline{\text{PCI\_CLK}}$	K03	$\overline{\text{SMS3}}$	R10	XTAL1
A04	ADDR8	D15	$\overline{\text{PCI\_PERR}}$	K04	V <sub>DDEXT</sub>	R11	PF7/ $\overline{\text{SPI1SEL3}}$ /DF
A05	ADDR6	D16	$\overline{\text{PCI\_REQ}}$	K07	GND	R12	PF12/ $\overline{\text{SPI0SEL6}}$
A06	ADDR2	D17	$\overline{\text{PCI\_CBE3}}$	K08	GND	R13	RSCLK0
A07	RX0	D18	$\overline{\text{PCI\_RST}}$	K09	GND	R14	DT0
A08	TX0	E01	$\overline{\text{AOE}}$	K10	GND	R15	TFS1
A09	XVER_DATA	E02	$\overline{\text{ABE0}}$ /SDQM0	K11	GND	R16	SCK1
A10	V <sub>SSPLL</sub>	E03	ADDR22	K12	GND	R17	PCI_AD30
A11	SUSPEND	E04	V <sub>DDEXT</sub>	K15	V <sub>DDPCIEXT</sub>	R18	PCI_AD22
A12	TMS	E15	$\overline{\text{PCI\_IRDY}}$	K16	PCI_AD17	T01	DATA2
A13	$\overline{\text{EMU}}$	E16	$\overline{\text{PCI\_CBE2}}$	K17	PCI_AD15	T02	DATA9
A14	BMODE1	E17	PCI_A00	K18	PCI_AD10	T03	DATA14
A15	$\overline{\text{PCI\_INTC}}$	E18	PCI_AD1	L01	$\overline{\text{SCKE}}$	T04	DATA15
A16	$\overline{\text{PCI\_LOCK}}$	F01	$\overline{\text{ARE}}$	L02	$\overline{\text{SRAS}}$	T05	DATA20
A17	$\overline{\text{PCI\_STOP}}$	F02	$\overline{\text{AMS0}}$	L03	$\overline{\text{SCAS}}$	T06	DATA25
A18	N/C	F03	ADDR24	L04	V <sub>DDEXT</sub>	T07	DATA30
B01	$\overline{\text{ABE1}}$ /SDQM1	F04	V <sub>DDINT</sub>	L07	GND	T08	PF2/ $\overline{\text{SPI0SEL1}}$ /MSEL2
B02	ADDR20	F15	$\overline{\text{PCI\_CBE1}}$	L08	GND	T09	PF6/ $\overline{\text{SPI0SEL3}}$ /MSEL6
B03	ADDR16	F16	$\overline{\text{PCI\_CBE0}}$	L09	GND	T10	XTAL0
B04	ADDR11	F17	PCI_AD3	L10	GND	T11	PF8/ $\overline{\text{SPI0SEL4}}$ /SSEL0
B05	ADDR7	F18	PCI_AD4	L11	GND	T12	PF11/ $\overline{\text{SPI1SEL5}}$
B06	ADDR3	G01	$\overline{\text{AWE}}$	L12	V <sub>DDINT</sub>	T13	PF15/ $\overline{\text{SPI1SEL7}}$
B07	TMR0	G02	$\overline{\text{AMS3}}$	L15	V <sub>DDPCIEXT</sub>	T14	TFS0
B08	RX1	G03	$\overline{\text{ABE2}}$ /SDQM2	L16	PCI_AD21	T15	TSCLK1
B09	$\overline{\text{RESET}}$	G04	V <sub>DDEXT</sub>	L17	PCI_AD20	T16	MISO0
B10	TXDPLS	G07	USB_CLK	L18	PCI_AD12	T17	MOSI1
B11	NMI	G08	V <sub>DDEXT</sub>	M01	SA10	T18	PCI_AD23
B12	$\overline{\text{TRST}}$	G09	V <sub>DDPLL</sub>	M02	$\overline{\text{SMS0}}$	U01	DATA7
B13	BMODE2	G10	TXDMNS	M03	DATA1	U02	DATA8
B14	BMODE0	G11	V <sub>DDINT</sub>	M04	V <sub>DDEXT</sub>	U03	DATA13
B15	$\overline{\text{PCI\_INTB}}$	G12	V <sub>DDINT</sub>	M07	GND	U04	DATA16
B16	$\overline{\text{PCI\_SERR}}$	G15	V <sub>DDINT</sub>	M08	V <sub>DDINT</sub>	U05	DATA21
B17	$\overline{\text{PCI\_TRDY}}$	G16	PCI_AD2	M09	GND	U06	DATA24
B18	PCI_IDSEL	G17	PCI_AD6	M10	GND	U07	DATA28
C01	ADDR23	G18	PCI_AD5	M11	V <sub>DDINT</sub>	U08	PF0/ $\overline{\text{SPISS0}}$ /MSEL0
C02	ADDR21	H01	CLKOUT/SCLK1	M12	V <sub>DDINT</sub>	U09	PF4/ $\overline{\text{SPI0SEL2}}$ /MSEL4
C03	ADDR18	H02	GND	M15	V <sub>DDPCIEXT</sub>	U10	V <sub>DDRTC</sub>
C04	ADDR13	H03	$\overline{\text{AMS2}}$	M16	PCI_AD25	U11	PF9/ $\overline{\text{SPI1SEL4}}$ /SSEL1
C05	ADDR9	H04	V <sub>DDINT</sub>	M17	PCI_AD24	U12	PF13/ $\overline{\text{SPI1SEL6}}$
C06	ADDR5	H07	$\overline{\text{ABE3}}$ /SDQM3	M18	PCI_AD14	U13	RFS0
C07	TMR1	H08	GND	N01	$\overline{\text{SMS2}}$	U14	RSCLK1
C08	TX1	H09	V <sub>DDINT</sub>	N02	DATA0	U15	DR1
C09	DPLS	H10	GND	N03	DATA4	U16	MOSI0
C10	$\overline{\text{TXEN}}$	H11	GND	N04	V <sub>DDINT</sub>	U17	SCK0
C11	TDI	H12	V <sub>DDINT</sub>	N15	V <sub>DDINT</sub>	U18	MISO1
C12	BYPASS	H15	V <sub>DDPCIEXT</sub>	N16	PCI_AD29	V01	N/C
C13	GND	H16	PCI_AD11	N17	PCI_AD26	V02	DATA10

# ADSP-BF535

Table 30. 260-Ball PBGA Pin Assignment (Numerically by Pin Number) (continued)

Pin	Signal	Pin	Signal	Pin	Signal	Pin	Signal
C14	PCI_INTA	H17	PCI_AD9	N18	PCI_AD18	V03	DATA11
C15	PCI_PAR	H18	PCI_AD7	P01	SMSI	V04	DATA17
C16	PCI_DEVSEL	J01	V <sub>DDEXT</sub>	P02	DATA3	V05	DATA18
C17	PCI_FRAME	J02	V <sub>DDEXT</sub>	P03	DATA6	V06	DATA22
C18	PCI_GNT	J03	SWE	P04	V <sub>DDEXT</sub>	V07	DATA26
D01	AMS $\bar{I}$	J04	V <sub>DDEXT</sub>	P15	PCI_AD28	V08	DATA27
D02	ADDR25	J07	GND	P16	PCI_AD31	V09	DATA31
D03	ADDR19	J08	GND	P17	PCI_AD27	V10	PF3/SPI0SEL1/MSEL3
D04	ADDR14	J09	GND	P18	PCI_AD19	V11	V <sub>SSRTC</sub>
D05	ADDR10	J10	GND	R01	ARDY	V12	PF10/SPI0SEL5
D06	ADDR4	J11	GND	R02	DATA5	V13	PF14/SPI0SEL7
D07	TMR2	J12	GND	R03	N/C	V14	DR0
D08	DMNS	J15	V <sub>DDPCIEXT</sub>	R04	DATA12	V15	TSCLK0
D09	CLKIN1	J16	PCI_AD16	R05	DATA19	V16	RFS1
D10	TCK	J17	PCI_AD13	R06	DATA23	V17	DT1
D11	TDO	J18	PCI_AD8	R07	DATA29	V18	N/C

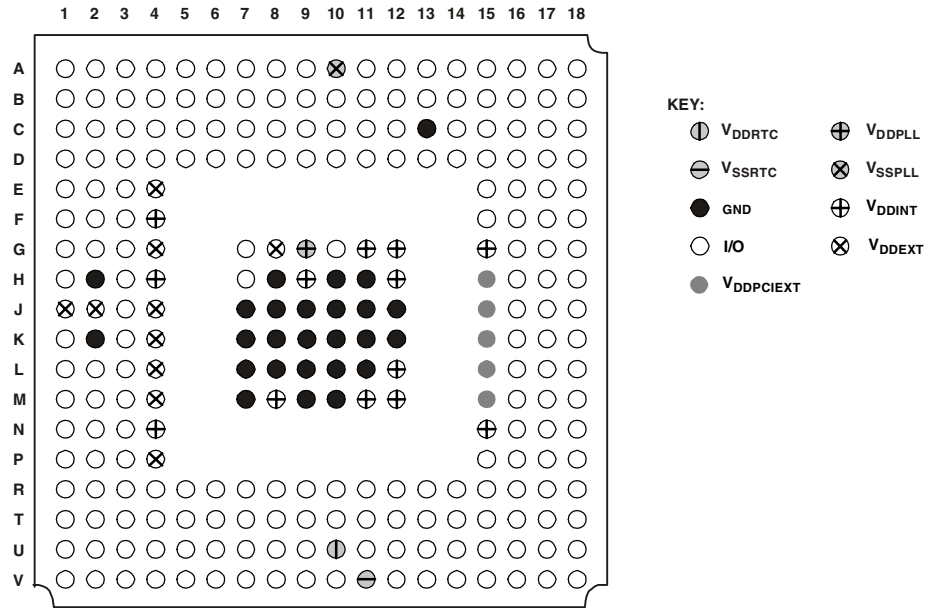

Figure 25. 260-Ball Metric PBGA Pin Configuration (Top View)

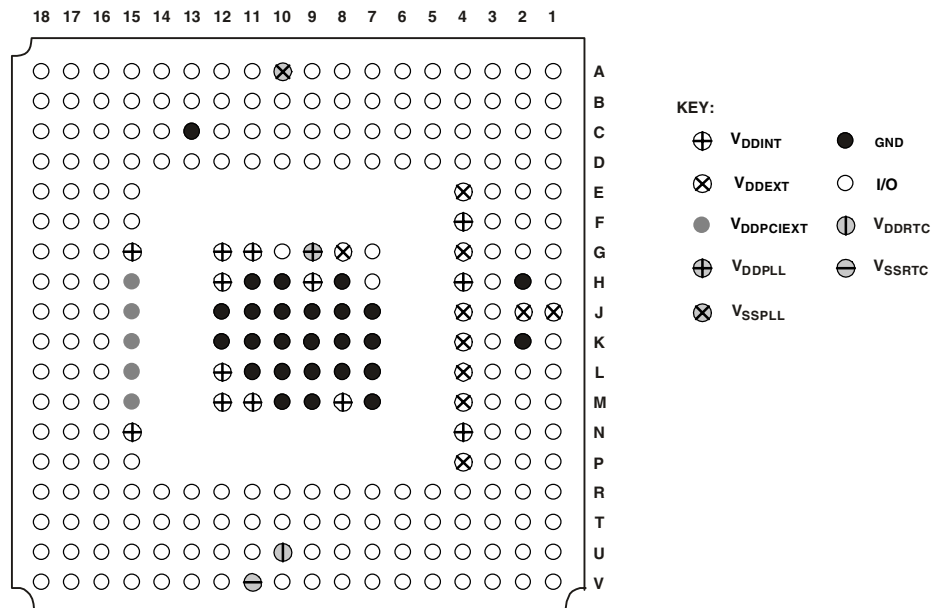

Figure 26. 260-Ball Metric PBGA Pin Configuration (Bottom View)

# ADSP-BF535

## OUTLINE DIMENSIONS

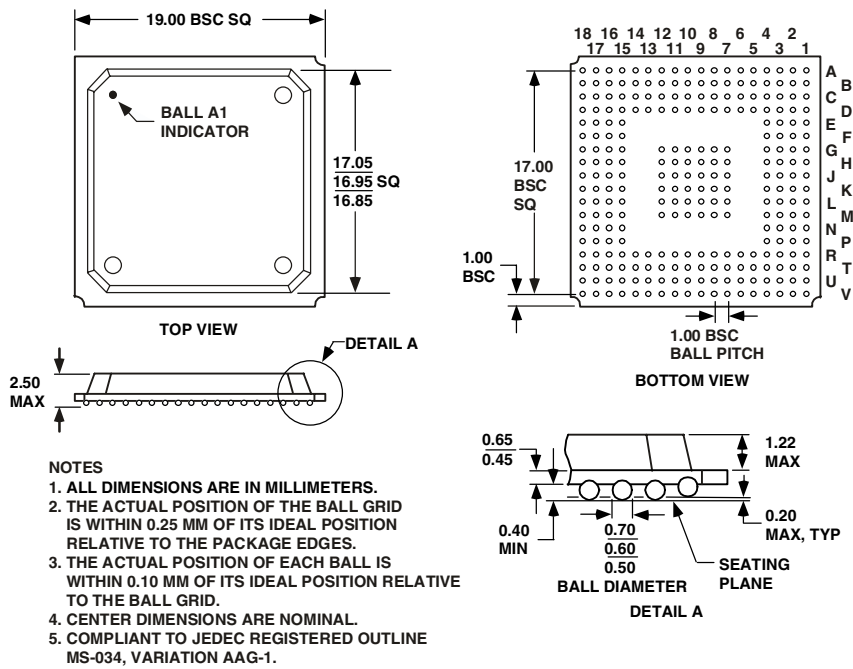

Figure 27. 260-Ball Metric Plastic Ball Grid Array (PBGA) (B-260)

## ORDERING GUIDE

Part Number	Temperature Range (Ambient)	Instruction Rate	Operating Voltage (V)
ADSP-BF535PKB-350	0°C to +70°C	350 MHz	1.0 V to 1.6 V internal, 3.3 V I/O
ADSP-BF535PKB-300	0°C to +70°C	300 MHz	1.0 V to 1.5 V internal, 3.3 V I/O
ADSP-BF535PBB-300	-40°C to +85°C	300 MHz	1.0 V to 1.5 V internal, 3.3 V I/O
ADSP-BF535PBB-200	-40°C to +85°C	200 MHz	1.0 V to 1.5 V internal, 3.3 V I/O

## Revision History

Location	Page
9/04—Data Sheet Changed from REV. 0 to REV. A	
Changes to Clock Signals Section .....	13
Changes to Recommended Operating Conditions Footnote References .....	21
Changes to Electrical Characteristics .....	21
Change to Table 11 .....	24
Change to Figure 11 .....	27
Change to Figure 12 .....	28
Change to Output Drive Currents Section .....	36
Replaced Figures 19, 20, and 21 .....	36
Changes to Power Dissipation Section .....	36
Change to Table 26 .....	36