

MIR500 Series

2W, Ultra-High Isolation DIP, Single & Dual Output DC/DC Converters

Key Features

- Low Cost
- 6000VDC Isolation
- MTBF > 600,000 Hours
- Short Circuit Protection
- Input 5, 12 and 24VDC
- Output 5, 12, 15, ± 5 , ± 12 and ± 15 VDC
- Regulated Outputs
- Low Isolation Capacitance
- Low Leakage Current
- Complies with EN55022 Class A



Minmax's MIR500 2W DC/DC's are specially designed to provide ultra-high levels of isolation 6000VDC in a low-profile DIP package.

The series consists of 18 models with input voltages of 5V, 12V and 24VDC which offers regulated output voltages of 5V, 12V, 15VDC in both single and dual output configurations.

The MIR500 series is an excellent selection for a variety of applications including mixed analog/digital subsystems, railroad/transportation equipments, medical equipment subsystems, process/machine control equipments and automatic test instrumentation.

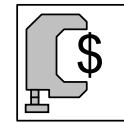

Low Cost

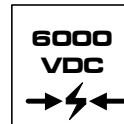

I/O Isolation



EN55022

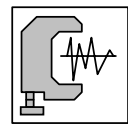

Low Noise

Block Diagram

Single Output

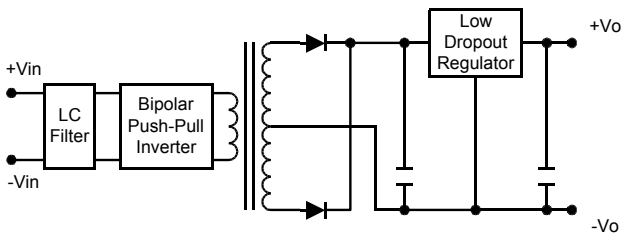

Dual Output

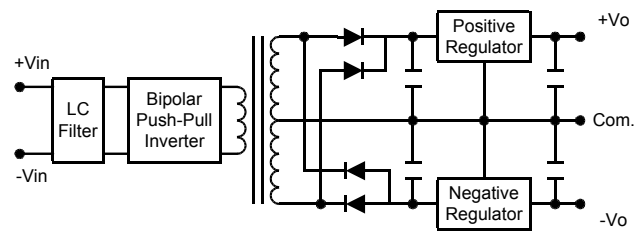

Model Selection Guide

Model Number	Input Voltage	Output Voltage	Output Current		Input Current		Reflected Ripple Current	Efficiency
			Max.	Min.	@Max. Load	@No Load		@Max. Load
	VDC	VDC	mA	mA	mA (Typ.)	mA (Typ.)	mA (Typ.)	% (Typ.)
MIR501	5 (4.5 ~ 5.5)	5	400	0	645	100	15	62
MIR502		12	165		629			63
MIR503		15	133		623			64
MIR504		±5	±100		476			42
MIR505		±12	±83		699			57
MIR506		±15	±66		695			57
MIR511	12 (10.8 ~ 13.2)	5	400	0	269	50	8	62
MIR512		12	165		262			63
MIR513		15	133		260			64
MIR514		±5	±100		185			45
MIR515		±12	±83		281			59
MIR516		±15	±66		280			59
MIR521	24 (21.6 ~ 26.4)	5	400	0	134	30	3	62
MIR522		12	165		131			63
MIR523		15	133		130			64
MIR524		±5	±100		93			45
MIR525		±12	±83		143			58
MIR526		±15	±66		142			58

Absolute Maximum Ratings

Parameter	Min.	Max.	Unit	
Input Surge Voltage (1000 mS)	5VDC Input Models	-0.7	7.5	VDC
	12VDC Input Models	-0.7	15	VDC
	24VDC Input Models	-0.7	30	VDC
Lead Temperature (1.5mm from case for 10 Sec.)	---	260	°C	
Internal Power Dissipation	---	2,000	mW	

Exceeding the absolute maximum ratings of the unit could cause damage. These are not continuous operating ratings.

Notes :

1. Specifications typical at Ta=+25°C, resistive load, nominal input voltage, rated output current unless otherwise noted.
2. Transient recovery time is measured to within 1% error band for a step change in output load of 50% to 100%.
3. Ripple & Noise measurement bandwidth is 0-20 MHz.
4. All DC/DC converters should be externally fused at the front end for protection.
5. Other input and output voltage may be available, please contact factory.
6. Specifications subject to change without notice.

Environmental Specifications

Parameter	Conditions	Min.	Max.	Unit
Operating Temperature	Ambient	-25	+60	°C
Operating Temperature	Case	-25	+90	°C
Storage Temperature		-40	+125	°C
Humidity		---	95	%
Cooling	Free-Air Convection			
Conducted EMI	EN55022 Class A			

Input Specifications

Parameter	Model	Min.	Typ.	Max.	Unit
Input Voltage Range	5V Input Models	4.5	5	5.5	VDC
	12V Input Models	10.8	12	13.2	
	24V Input Models	21.6	24	26.4	
Reverse Polarity Input Current	All Models	---	---	0.5	A
Short Circuit Input Power		---	---	2000	mW
Input Filter		Pi Filter			

Output Specifications

Parameter	Conditions	Min.	Typ.	Max.	Unit
Output Voltage Accuracy		---	±2.0	±4.0	%
Output Voltage Balance	Dual Output, Balanced Loads	---	±2.0	±4.0	%
Line Regulation	Vin=Min. to Max.	---	±0.3	±0.5	%
Load Regulation	Io=10% to 100%	---	±0.5	±1.0	%
Ripple & Noise (20MHz)		---	30	50	mV P-P
Ripple & Noise (20MHz)	Over Line, Load & Temp.	---	---	100	mV P-P
Ripple & Noise (20MHz)		---	---	5	mV rms
Over Load		120	---	---	%
Transient Recovery Time	50% Load Step Change	---	---	50	µs
Transient Response Deviation		---	---	±6	%
Temperature Coefficient		---	±0.01	±0.02	%/°C
Output Short Circuit	Continuous				

General Specifications

Parameter	Conditions	Min.	Typ.	Max.	Unit
Isolation Voltage Rated	60 Seconds	6000	---	---	VDC
Isolation Voltage Test	Flash Tested for 1 Second	8000	---	---	VDC
Leakage Current	240VAC, 60Hz	---	---	2	µA
Isolation Resistance	500VDC	10	---	---	GΩ
Isolation Capacitance	100KHz, 1V	---	20	30	pF
Switching Frequency		25	---	80	KHz
MTBF	MIL-HDBK-217F @ 25°C, Ground Benign	600	---	---	K Hours

Capacitive Load

Models by Vout	5V	12V	15V	±5V #	±12V #	±15V #	Unit
Maximum Capacitive Load	680	680	680	270	270	270	µF

For each output

Input Fuse Selection Guide

5V Input Models	12V Input Models	24V Input Models
1000mA Slow – Blow Type	500mA Slow – Blow Type	250mA Slow – Blow Type

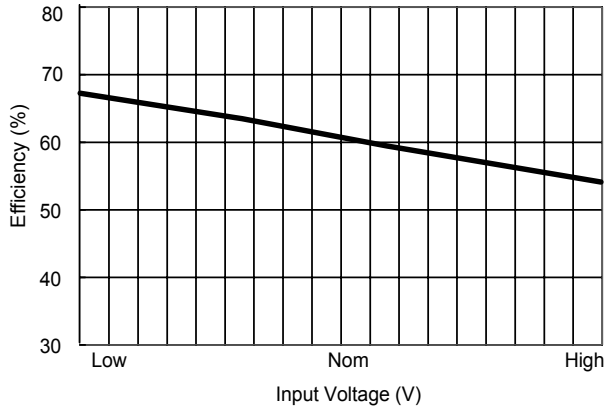

Efficiency vs Input Voltage (Single Output)

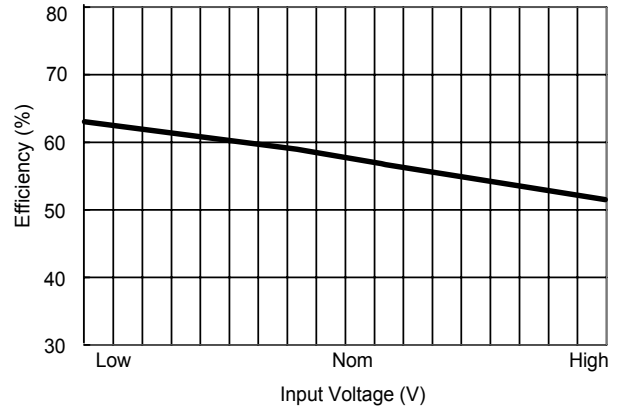

Efficiency vs Input Voltage (Dual Output)

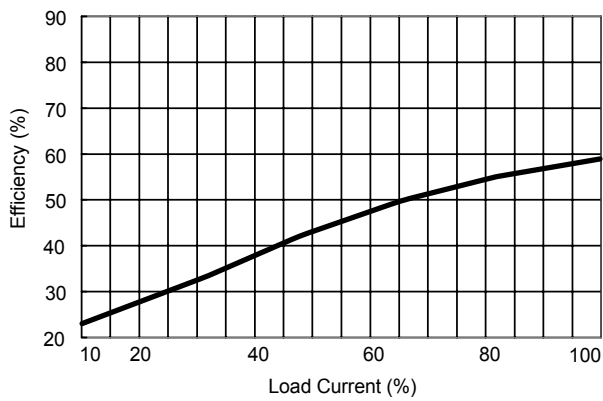

Efficiency vs Output Load (Single Output)

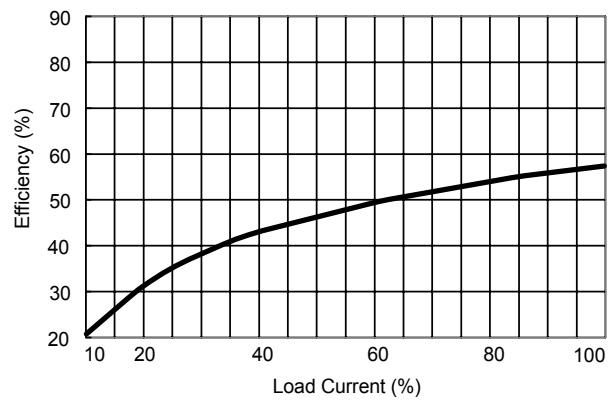

Efficiency vs Output Load (Dual Output)

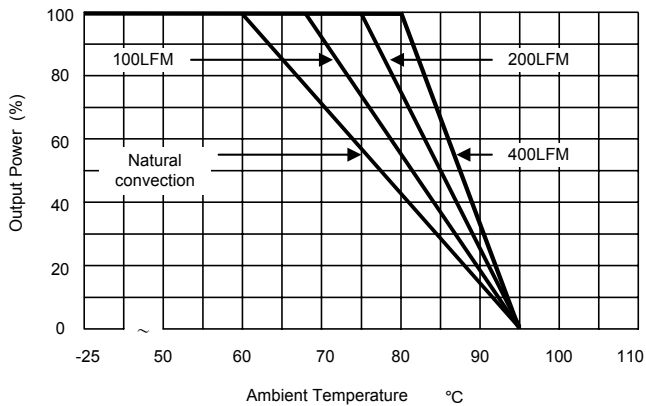

Derating Curve

Test Configurations

Input Reflected-Ripple Current Test Setup

Input reflected-ripple current is measured with an inductor L_{in} (4.7uH) and C_{in} (220uF, ESR < 1.0Ω at 100 KHz) to simulate source impedance.

Capacitor C_{in} , offsets possible battery impedance. Current ripple is measured at the input terminals of the module, measurement bandwidth is 0–500 KHz.

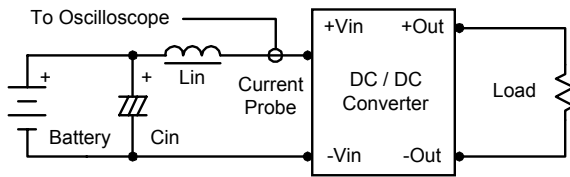

Peak-to-Peak Output Noise Measurement Test

Use a C_{out} 0.33uF ceramic capacitor.

Scope measurement should be made by using a BNC socket, measurement bandwidth is 0–20 MHz. Position the load between 50 mm and 75 mm from the DC/DC Converter.

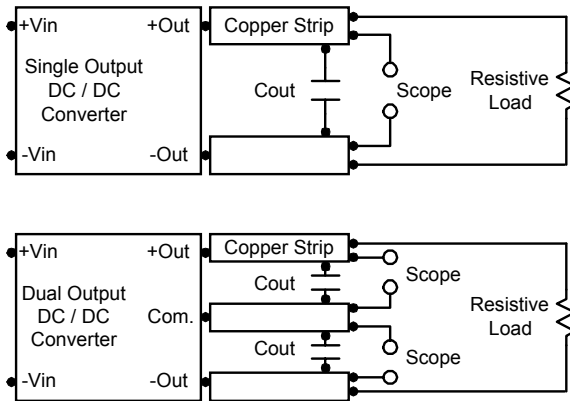

Design & Feature Considerations

Maximum Capacitive Load

The MIR500 series has limitation of maximum connected capacitance at the output.

The power module may be operated in current limiting mode during start-up, affecting the ramp-up and the startup time.

For optimum performance we recommend 270uF maximum capacitive load for dual outputs and 680uF capacitive load for single outputs.

The maximum capacitance can be found in the data sheet.

Input Source Impedance

The power module should be connected to a low ac-impedance input source. Highly inductive source impedances can affect the stability of the power module.

In applications where power is supplied over long lines and output loading is high, it may be necessary to use a capacitor at the input to ensure startup.

Capacitor mounted close to the power module helps ensure stability of the unit, it is recommended to use a good quality low Equivalent Series Resistance (ESR < 1.0Ω at 100 KHz) capacitor of a 4.7uF for the 5V input devices and a 2.2uF for the 12V and 24V devices.

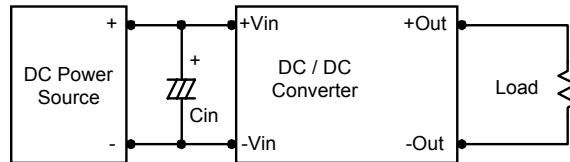

Output Ripple Reduction

A good quality low ESR capacitor placed as close as practicable across the load will give the best ripple and noise performance.

To reduce output ripple, it is recommended to use 1.5uF capacitors at the output.

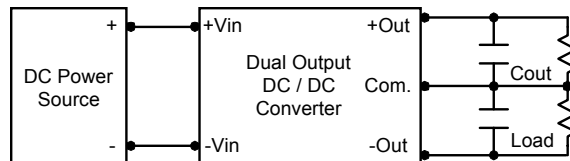
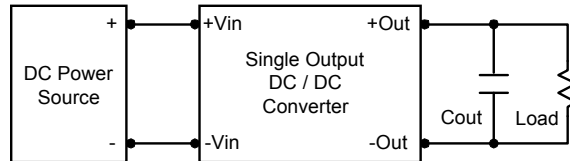

Thermal Considerations

Many conditions affect the thermal performance of the power module, such as orientation, airflow over the module and board spacing. To avoid exceeding the maximum temperature rating of the components inside the power module, the case temperature must be kept below 90°C.

The derating curves are determined from measurements obtained in an experimental apparatus.

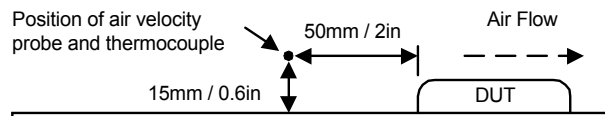

Mechanical Dimensions

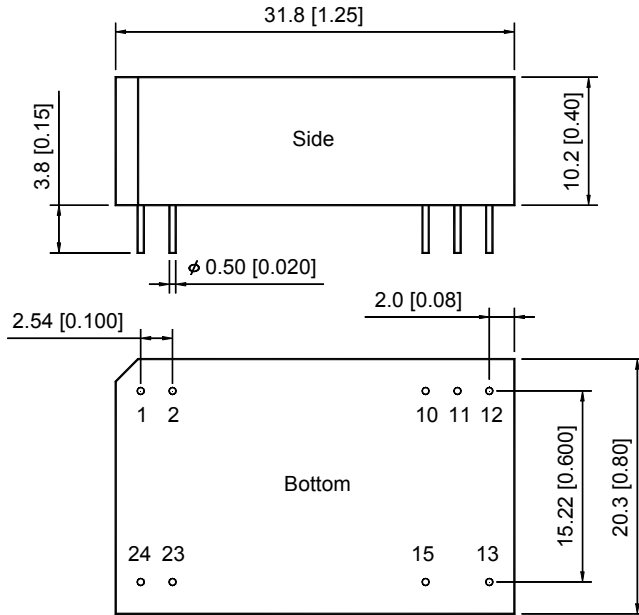

Tolerance	Millimeters	Inches
	X.X±0.25	X.XX±0.01
	X.XX±0.13	X.XXX±0.005
Pin	±0.05	±0.002

Connecting Pin Patterns

Top View (2.54 mm / 0.1 inch grids)

Single Output

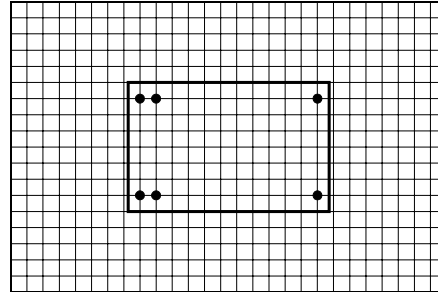

Dual Output

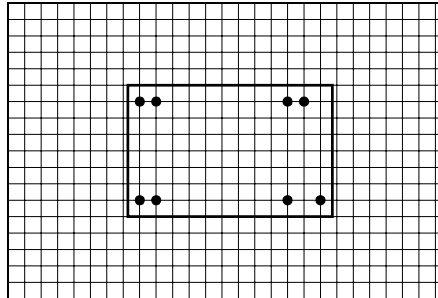

Pin Connections

Pin	Single Output	Dual Output
1	+Vin	+Vin
2	+Vin	+Vin
10	No Pin	Common
11	No Pin	Common
12	-Vout	No Pin
13	+Vout	-Vout
15	No Pin	+Vout
23	-Vin	-Vin
24	-Vin	-Vin

Physical Characteristics

Case Size	: 31.8×20.3×10.2 mm 1.25×0.80×0.40 inches
Case Material	: Non-Conductive Black Plastic
Weight	: 12.4g
Flammability	: UL94V-0

The MIR500 converter is encapsulated in a low thermal resistance molding compound that has excellent resistance/electrical characteristics over a wide temperature range or in high humidity environments. The encapsulant and unit case are both rated to UL 94V-0 flammability specifications. Leads are tin plated for improved solderability.