



## Dual N-Channel 30-V (D-S) MOSFET with Schottky Diode

PRODUCT SUMMARY		
$V_{DS}$ (V)	$r_{DS(on)}$ ( $\Omega$ )	$I_D$ (A)
30	0.022 @ $V_{GS} = 10$ V	7.5
	0.030 @ $V_{GS} = 4.5$ V	6.5

SCHOTTKY PRODUCT SUMMARY		
$V_{DS}$ (V)	$V_{SD}$ (V) Diode Forward Voltage	$I_F$ (A)
30	0.50 V @ 1.0 A	2.0

**LITTLE FOOT PLUS™**

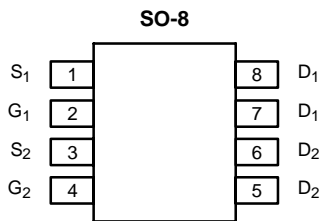

Top View

Ordering Information: Si4808DY  
Si4808DY-T1 (with Tape and Reel)

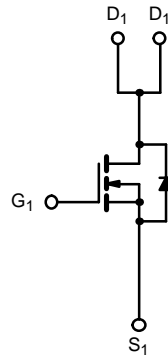

N-Channel MOSFET

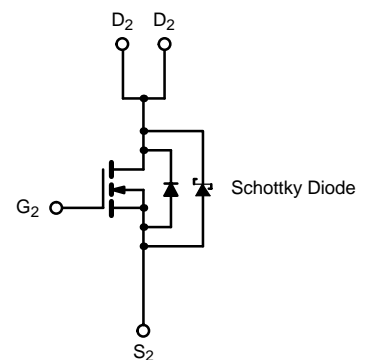

N-Channel MOSFET

ABSOLUTE MAXIMUM RATINGS ( $T_A = 25^\circ\text{C}$ UNLESS OTHERWISE NOTED)					
Parameter	Symbol	10 secs	Steady State	Unit	
Drain-Source Voltage	$V_{DS}$	30		V	
Gate-Source Voltage	$V_{GS}$	$\pm 20$			
Continuous Drain Current ( $T_J = 150^\circ\text{C}$ ) <sup>a</sup>	$I_D$	$T_A = 25^\circ\text{C}$	7.5	5.7	A
		$T_A = 70^\circ\text{C}$	6.0	4.6	
Pulsed Drain Current	$I_{DM}$	30		A	
Continuous Source Current (Diode Conduction) <sup>a</sup>	$I_S$	1.7	0.9		
Maximum Power Dissipation <sup>a</sup>	$P_D$	$T_A = 25^\circ\text{C}$	2.0	1.1	W
		$T_A = 70^\circ\text{C}$	1.3	0.7	
Operating Junction and Storage Temperature Range	$T_J, T_{stg}$	-55 to 150		$^\circ\text{C}$	

THERMAL RESISTANCE RATINGS							
Parameter	Symbol	MOSFET		Schottky		Unit	
		Typ	Max	Typ	Max		
Maximum Junction-to-Ambient <sup>a</sup>	$R_{thJA}$	$t \leq 10$ sec	52	62.5	53	62.5	$^\circ\text{C/W}$
		Steady-State	93	110	93	110	
Maximum Junction-to-Foot (Drain)	$R_{thJC}$	35	40	35	40		

Notes

a. Surface Mounted on 1" x 1" FR4 Board.

<b>MOSFET SPECIFICATIONS (<math>T_J = 25^\circ\text{C}</math> UNLESS OTHERWISE NOTED).</b>							
Parameter	Symbol	Test Condition	Min	Typ <sup>a</sup>	Max	Unit	
<b>Static</b>							
Gate Threshold Voltage	$V_{GS(th)}$	$V_{DS} = V_{GS}, I_D = 250\ \mu\text{A}$	0.8			V	
Gate-Body Leakage	$I_{GSS}$	$V_{DS} = 0\ \text{V}, V_{GS} = \pm 20\ \text{V}$			$\pm 100$	nA	
Zero Gate Voltage Drain Current	$I_{DSS}$	$V_{DS} = 24\ \text{V}, V_{GS} = 0\ \text{V}$	Ch-1		1	$\mu\text{A}$	
			Ch-2		100		
		$V_{DS} = 24\ \text{V}, V_{GS} = 0\ \text{V}, T_J = 85^\circ\text{C}$	Ch-1		15		
			Ch-2		2000		
On-State Drain Current <sup>b</sup>	$I_{D(on)}$	$V_{DS} = 5\ \text{V}, V_{GS} = 10\ \text{V}$	20			A	
Drain-Source On-State Resistance <sup>b</sup>	$r_{DS(on)}$	$V_{GS} = 10\ \text{V}, I_D = 7.5\ \text{A}$		0.018	0.022	$\Omega$	
		$V_{GS} = 4.5\ \text{V}, I_D = 6.5\ \text{A}$		0.024	0.030		
Forward Transconductance <sup>b</sup>	$g_{fs}$	$V_{DS} = 15\ \text{V}, I_D = 7.5\ \text{A}$		22		S	
Diode Forward Voltage <sup>b</sup>	$V_{SD}$	$I_S = 1\ \text{A}, V_{GS} = 0\ \text{V}$	Ch-1		0.8	1.2	V
			Ch-2		0.47	0.5	
<b>Dynamic<sup>a</sup></b>							
Total Gate Charge	$Q_g$	$V_{DS} = 15\ \text{V}, V_{GS} = 10\ \text{V}, I_D = 7.5\ \text{A}$		13	20	nC	
Gate-Source Charge	$Q_{gs}$			2			
Gate-Drain Charge	$Q_{gd}$			2.7			
Gate Resistance	$R_g$		0.5		3.2	$\Omega$	
Turn-On Delay Time	$t_{d(on)}$	$V_{DD} = 15\ \text{V}, R_L = 15\ \Omega$ $I_D \cong 1\ \text{A}, V_{GEN} = 10\ \text{V}, R_G = 6\ \Omega$		8	16	ns	
Rise Time	$t_r$			10	20		
Turn-Off Delay Time	$t_{d(off)}$			21	40		
Fall Time	$t_f$			10	20		
Source-Drain Reverse Recovery Time	$t_{rr}$	$I_F = 1.7\ \text{A}, di/dt = 100\ \text{A}/\mu\text{s}$	Ch-1		40	80	
			Ch-2		32	70	

## Notes

- a. Guaranteed by design, not subject to production testing.  
b. Pulse test; pulse width  $\leq 300\ \mu\text{s}$ , duty cycle  $\leq 2\%$ .

<b>SCHOTTKY SPECIFICATIONS (<math>T_J = 25^\circ\text{C}</math> UNLESS OTHERWISE NOTED)</b>						
Parameter	Symbol	Test Condition	Min	Typ	Max	Unit
Forward Voltage Drop	$V_F$	$I_F = 1.0\ \text{A}$		0.47	0.50	V
		$I_F = 1.0\ \text{A}, T_J = 125^\circ\text{C}$		0.36	0.42	
Maximum Reverse Leakage Current	$I_{rm}$	$V_r = 30\ \text{V}$		0.004	0.100	mA
		$V_r = 30\ \text{V}, T_J = 100^\circ\text{C}$		0.7	10	
		$V_r = -30\ \text{V}, T_J = 125^\circ\text{C}$		3.0	20	
Junction Capacitance	$C_T$	$V_r = 10\ \text{V}$		50		pF



**TYPICAL CHARACTERISTICS (25°C UNLESS NOTED) MOSFET**

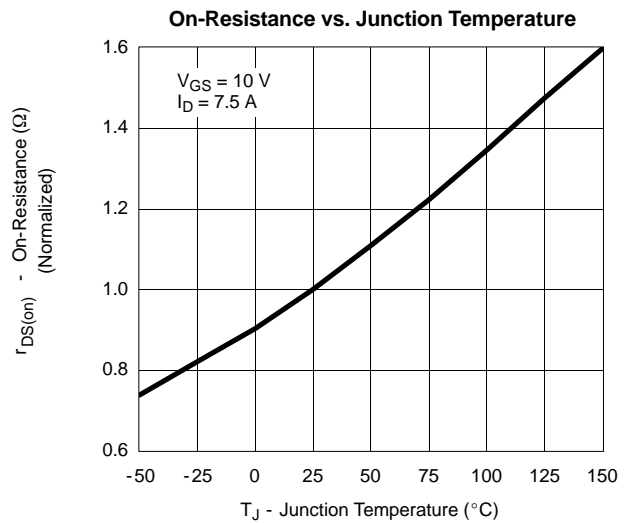
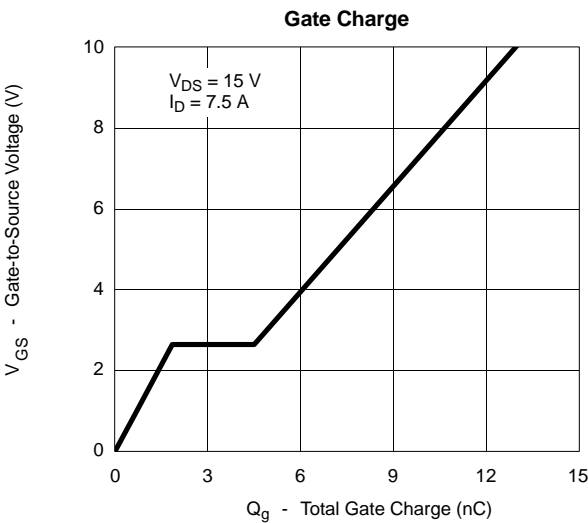
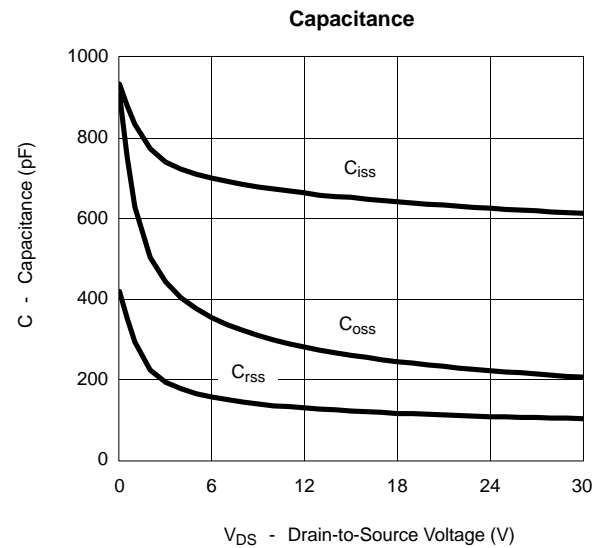
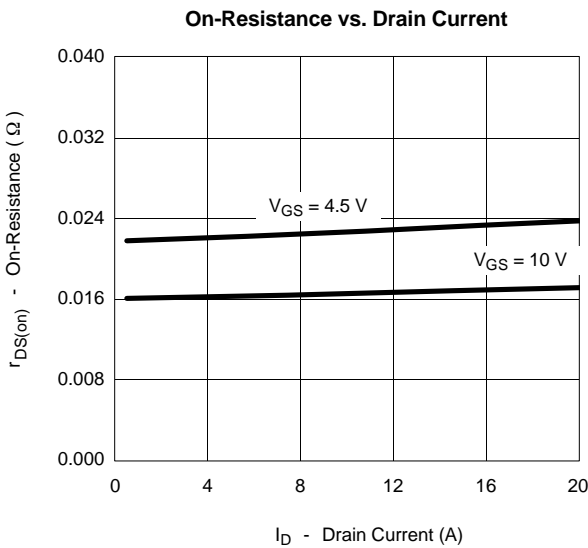
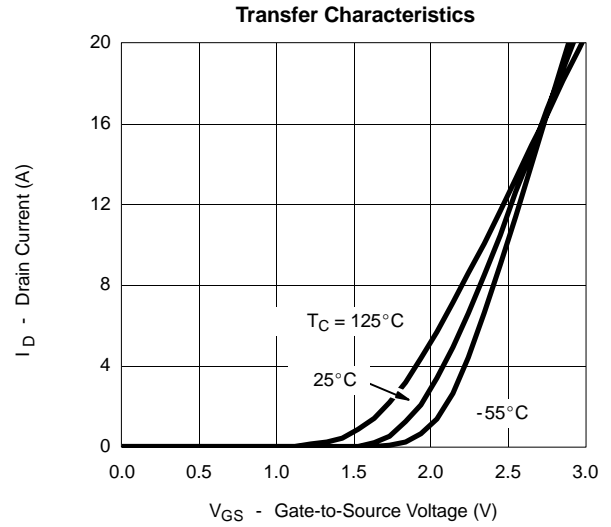
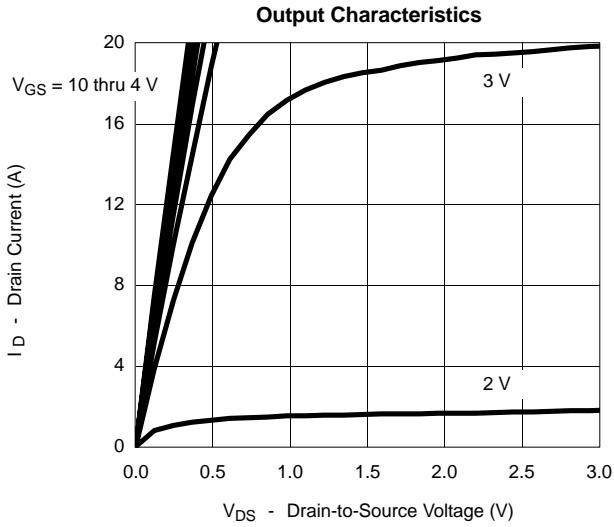

**TYPICAL CHARACTERISTICS (25 °C UNLESS NOTED)**

**MOSFET**

**Source-Drain Diode Forward Voltage**

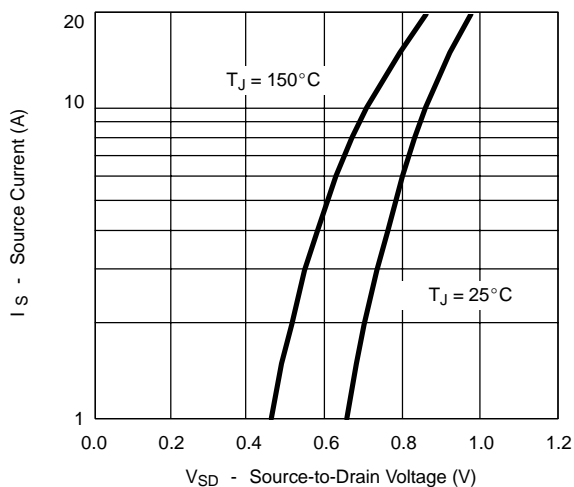

**On-Resistance vs. Gate-to-Source Voltage**

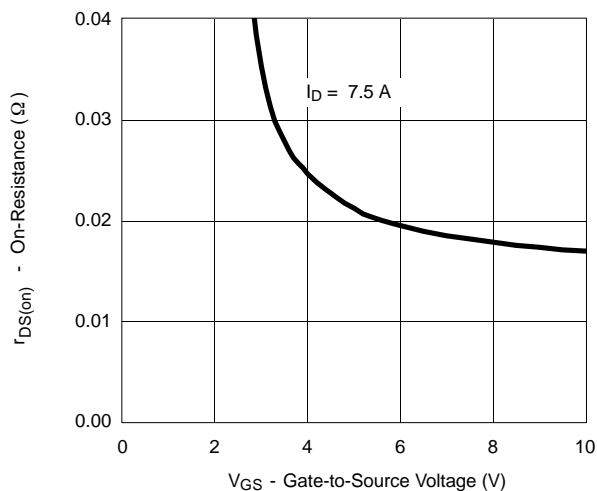

**Threshold Voltage**

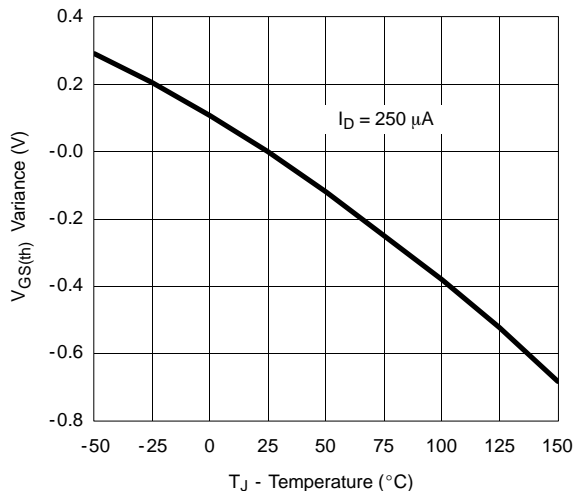

**Single Pulse Power**

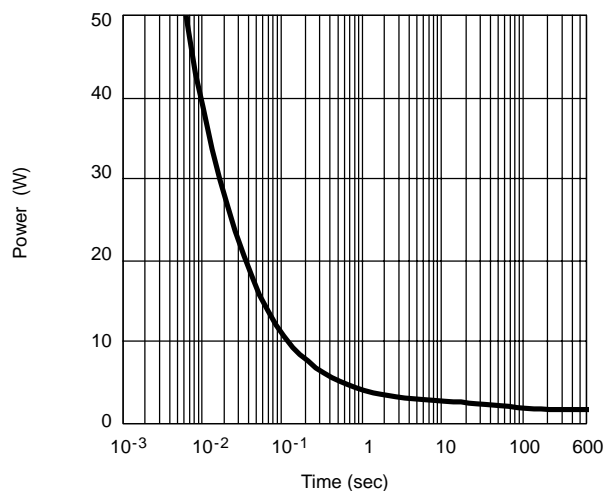

**Normalized Thermal Transient Impedance, Junction-to-Ambient**

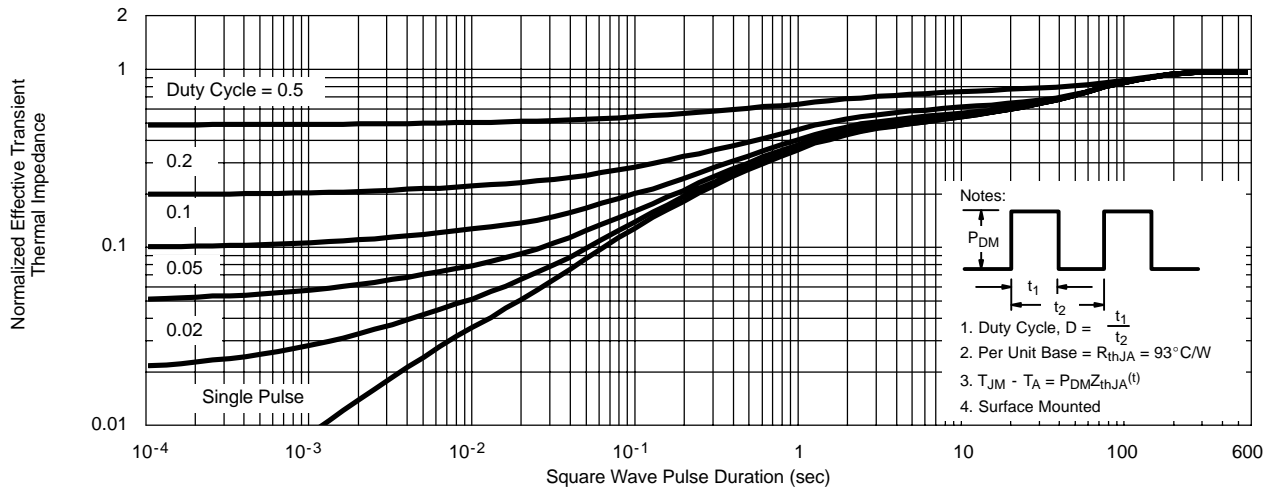



**TYPICAL CHARACTERISTICS (25 °C UNLESS NOTED) MOSFET**

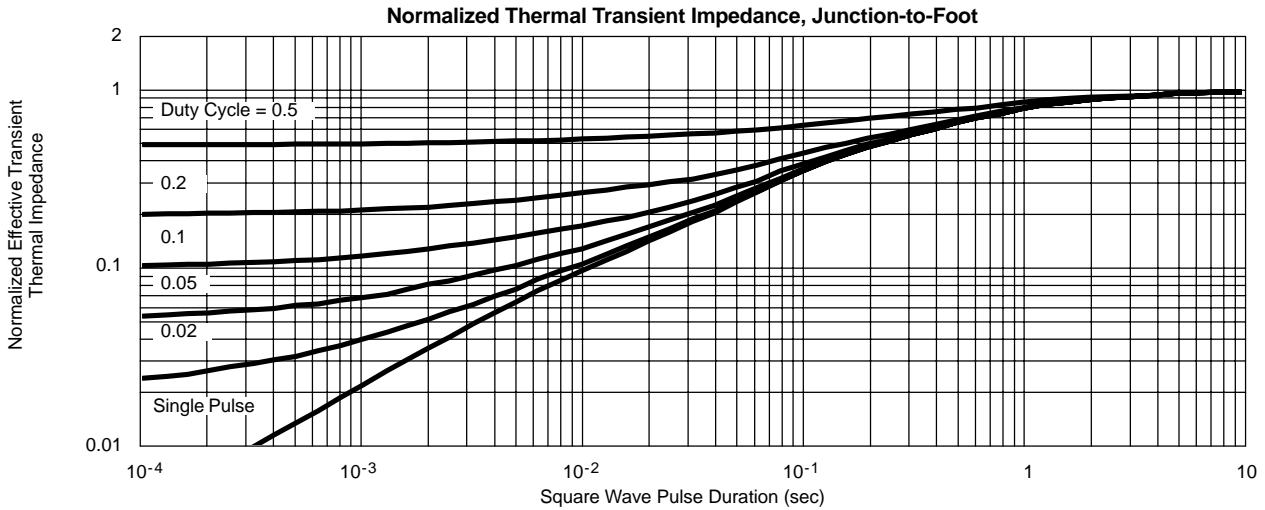

**TYPICAL CHARACTERISTICS (25 °C UNLESS NOTED) SCHOTTKY**

