



Load Switch with Level-Shift

PRODUCT SUMMARY		
V_{DS2} (V)	$r_{DS(on)}$ (Ω)	I_D (A)
20	0.017 @ $V_{GS2} = 4.5$ V	6.5
	0.024 @ $V_{GS2} = 2.5$ V	5.5

FEATURES

- TrenchFET® Power MOSFET
- LITTLE FOOT Plus™ Level Shift

APPLICATIONS

- Low Voltage BUS/Load Switching

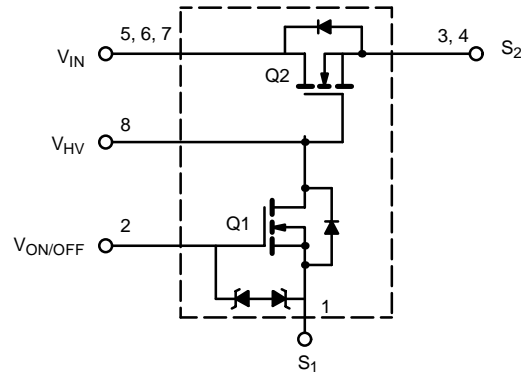
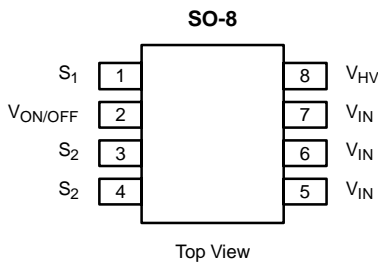

ABSOLUTE MAXIMUM RATINGS ($T_A = 25^\circ\text{C}$ UNLESS OTHERWISE NOTED)			
Parameter	Symbol	Limit	Unit
Input Voltage	V_{IN}	20	V
ON/OFF Voltage	$V_{ON/OFF}$	8	
Load Current	I_L	Continuous ^a	6.5
		Pulsed ^b	± 30
Continuous Intrinsic Diode Conduction ^a	I_S	-1.15	A
Maximum Power Dissipation ^a	P_D	1.25	W
Operating Junction and Storage Temperature Range	T_J, T_{stg}	-55 to 150	$^\circ\text{C}$
ESD Rating, MIL-STD-883D Human Body Model (100 pF, 1500 Ω)	ESD	3	kV

THERMAL RESISTANCE RATINGS				
Parameter	Symbol	Typical	Maximum	Unit
Maximum Junction-to-Ambient (t = steady state) ^a	R_{thJA}	80	100	$^\circ\text{C/W}$
Maximum Junction-to-Foot (Q2)	R_{thJC}	25	30	

SPECIFICATIONS ($T_J = 25^\circ\text{C}$ UNLESS OTHERWISE NOTED)						
Parameter	Symbol	Test Condition	Min	Typ	Max	Unit
OFF Characteristics						
Reverse Leakage Current	I_{FL}	$V_{IN} = 20$ V, $V_{ON/OFF} = 0$ V, $V_{HV} = 0$ V			1	μA
Diode Forward Voltage	V_{SD}	$I_S = -1.15$ A		0.65	1	V
ON Characteristics						
On-Resistance (Q2)	$r_{DS(on)}$	$V_{ON/OFF} = 0$ V, $I_D = 7$ A, $V_{HV} = 4.5$ V, $V_{S2} = 0$ V		0.014	0.017	Ω
		$V_{ON/OFF} = 0$ V, $I_D = 6$ A, $V_{HV} = 2.5$ V, $V_{S2} = 0$ V		0.0195	0.024	
On-State (Q2) Drain-Current	$I_{D(on)}$	$V_{IN-OUT} \leq 0.1$ V, $V_{IN} = 5$ V, $V_{ON/OFF} = 0$ V, $V_{HV} = 4.5$ V	20			A

Notes

- Surface Mounted on FR4 Board.
- Pulse test: pulse width ≤ 300 μs , duty cycle $\leq 2\%$.

TYPICAL CHARACTERISTICS (25 °C UNLESS NOTED)

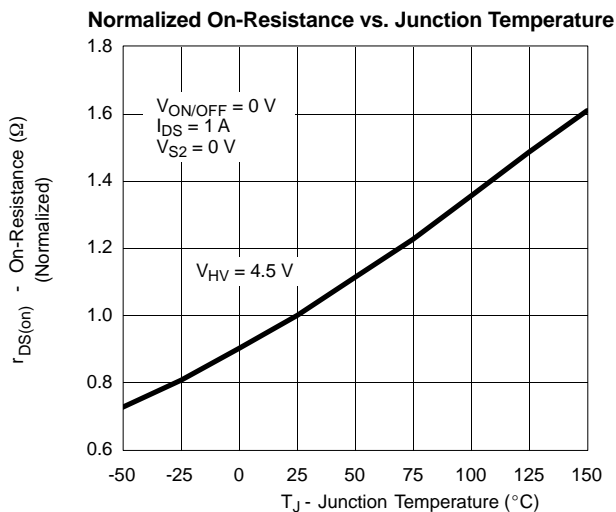
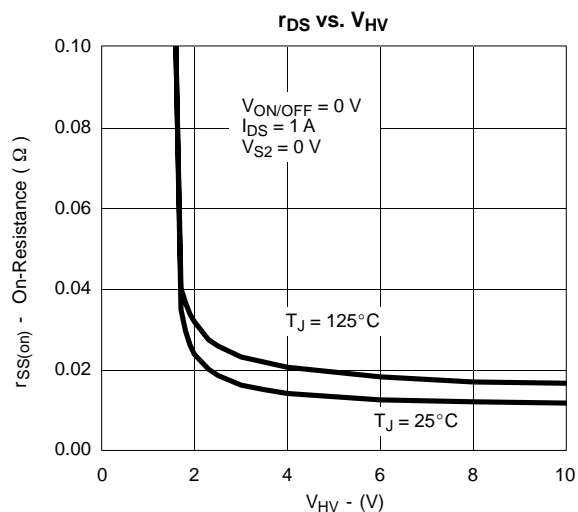
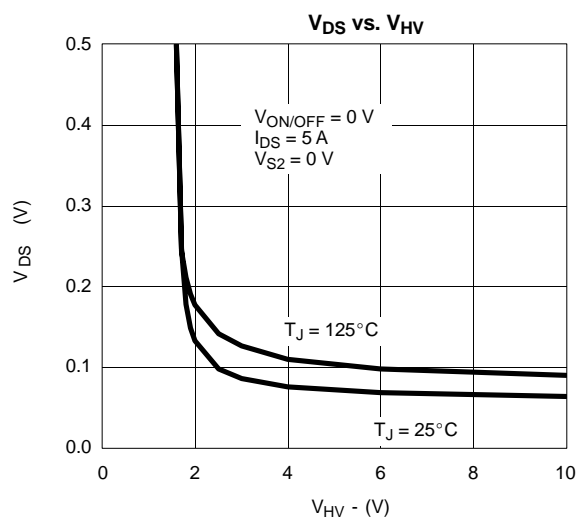
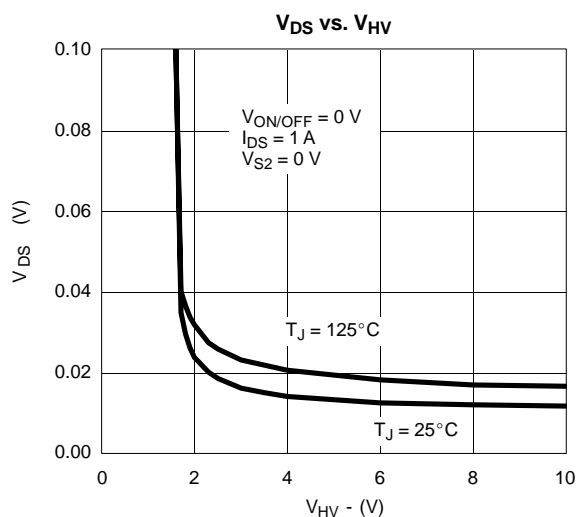
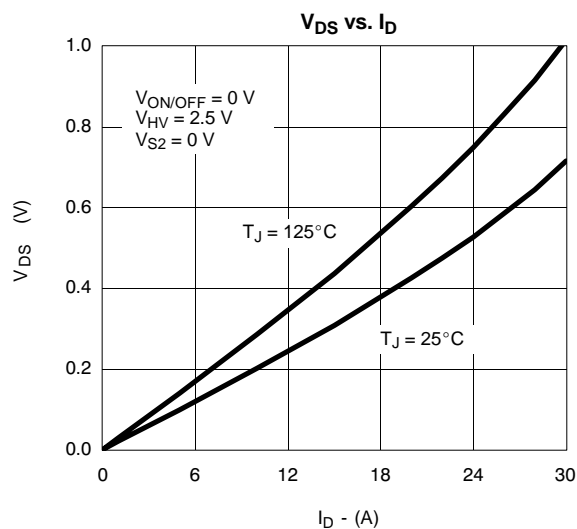
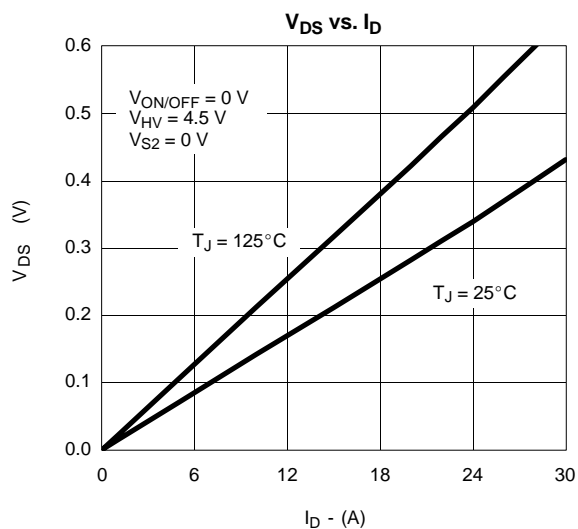



TYPICAL CHARACTERISTICS (25°C UNLESS NOTED)

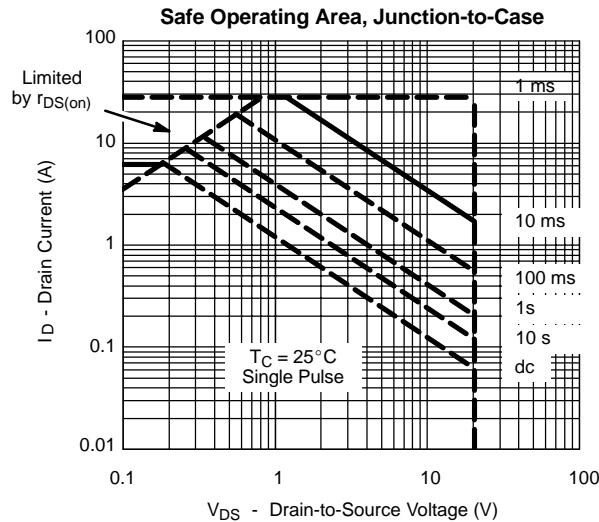
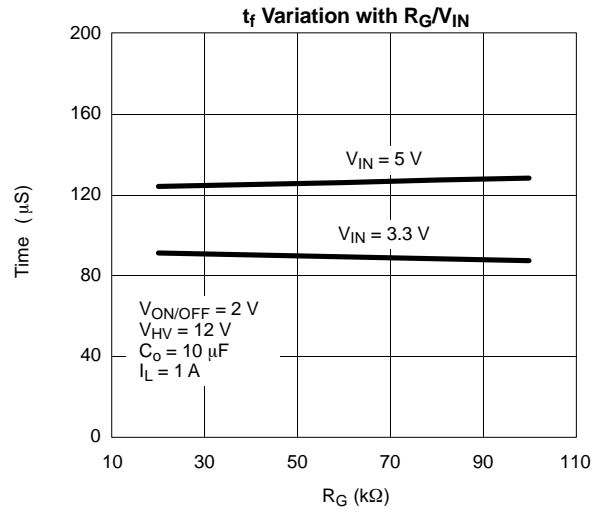
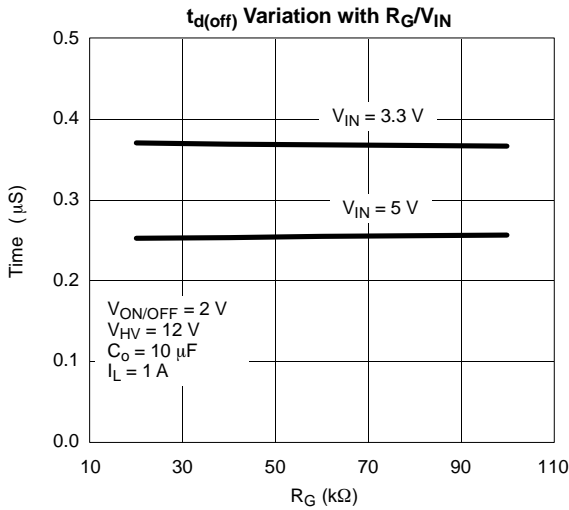
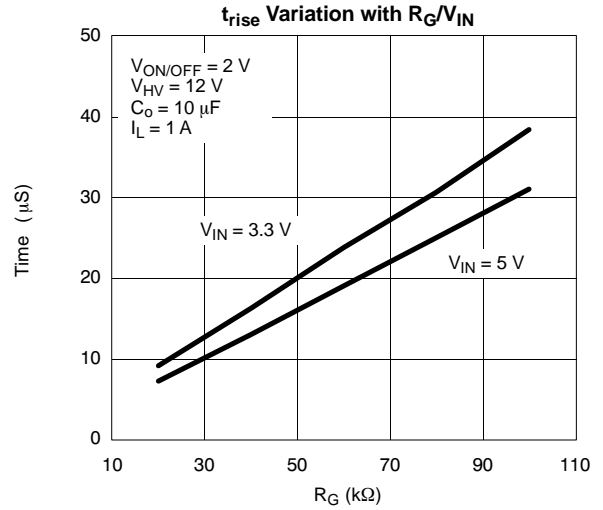
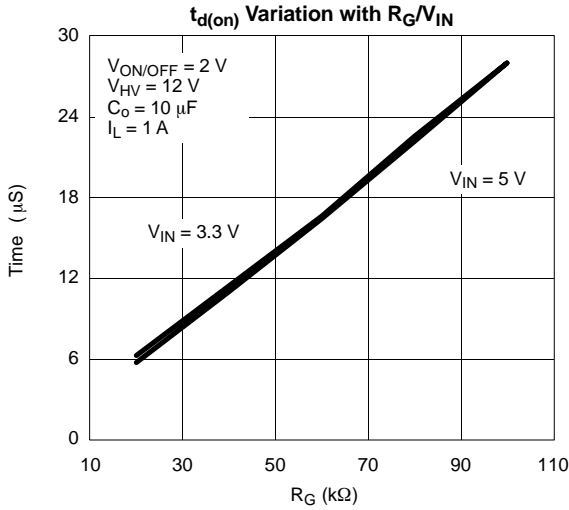

TYPICAL CHARACTERISTICS (25°C UNLESS NOTED)

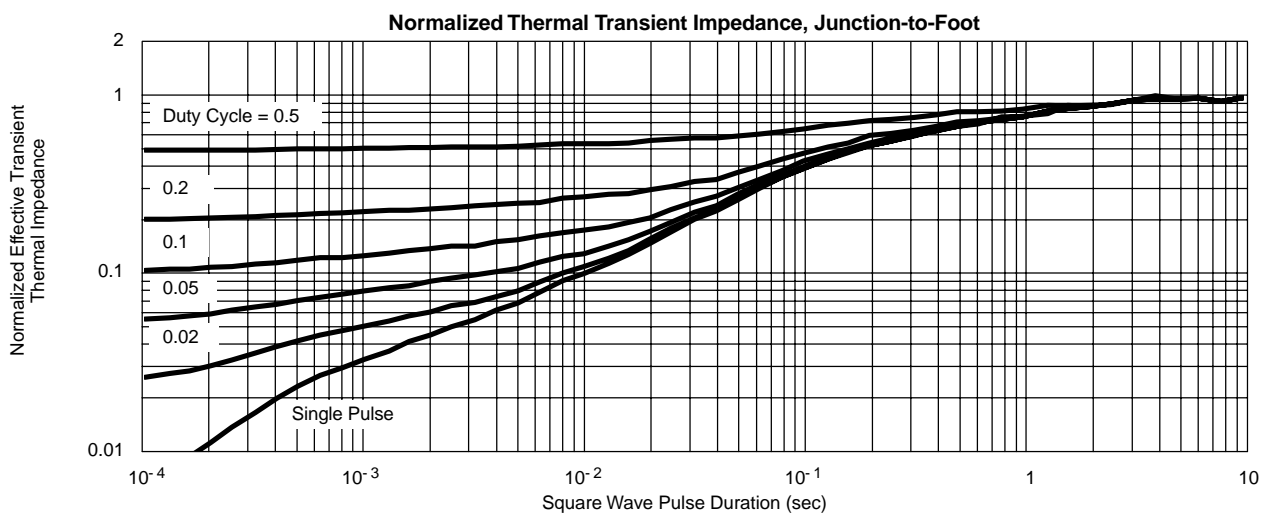
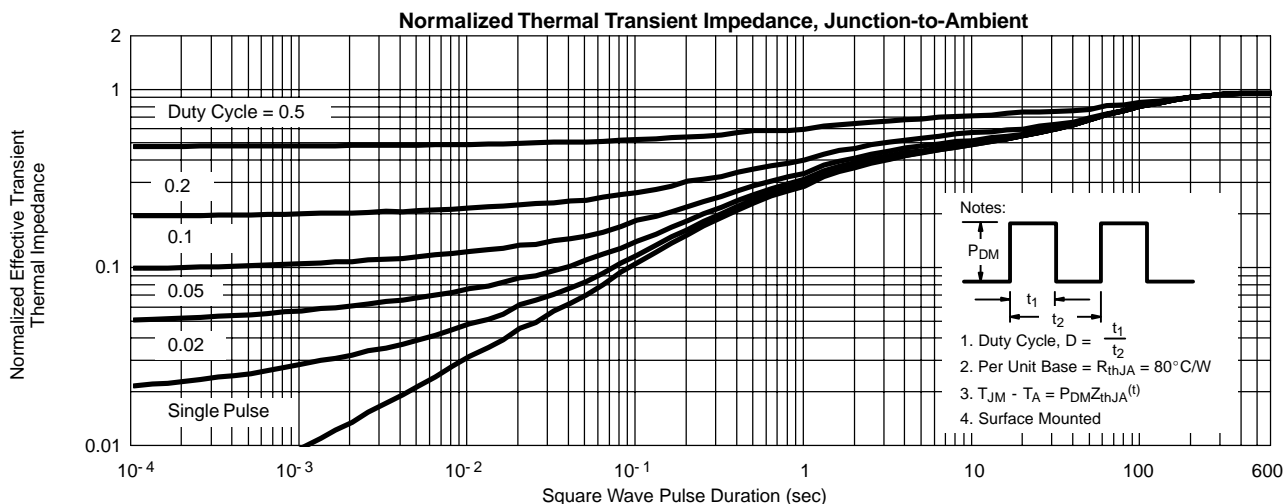

TYPICAL APPLICATION CIRCUIT

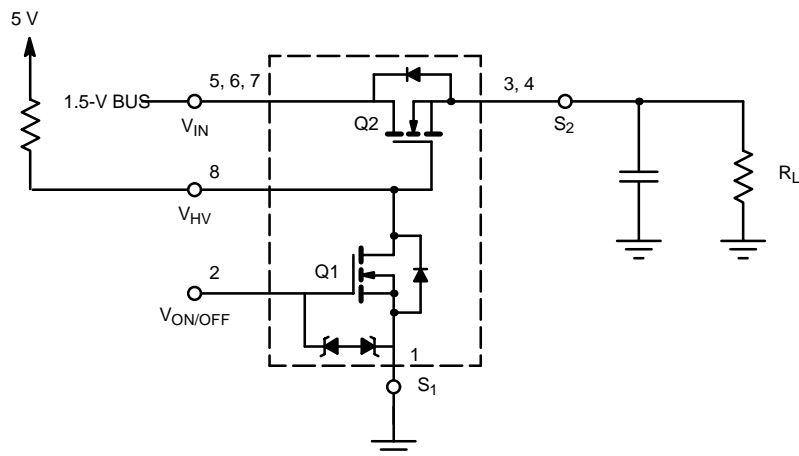

NOTE: Voltage difference between pull-up voltage, 5 V, and BUS voltage, 1.5 V, should be greater than 2.5 V.